

AXL E EC IOL8 DI4 M12 6P - Communication module



2701524

<https://www.phoenixcontact.com/us/products/2701524>

Please be informed that the data shown in this PDF document is generated from our online catalog. Please find the complete data in the user documentation. Our general terms of use for downloads are valid.



Axioline E, EtherCAT®, M12 connector, IO-Link ports Class A: 4, connection method: M12 connector, connection technology: 3-conductor, IO-Link ports Class B: 4, connection method: M12 connector, connection technology: 3-conductor, Digital inputs at pin 2 for class A ports: 4, 24 V DC, connection technology: 3-conductor, Plastic housing, degree of protection: IP65/IP67

Product description

The Axioline E EtherCAT® IO-Link master is designed for use within an EtherCAT® network. It enables the operation of up to eight IO-Link sensors/actuators and is also used to acquire digital signals.

Your advantages

- Connection to EtherCAT® network using M12 connectors (D-coded)
- Transmission speed of 100 Mbps
- Connection of four IO-Link devices with additional digital input
- Connection of four IO-Link actuators with additional power supply
- Connection of IO-Link ports using M12connectors (A-coded, 5-pos.)
- IO-Link specification V1.1.2
- Diagnostic and status indicators
- Short-circuit and overload protection of the sensor supply
- IP65/IP67 degree of protection

Commercial data

Item number	2701524
Packing unit	1 pc
Minimum order quantity	1 pc
Sales key	DR04
Product key	DRI7DE
Catalog page	Page 169 (C-6-2019)
GTIN	4046356763745
Weight per piece (including packing)	555.5 g
Weight per piece (excluding packing)	551.4 g
Customs tariff number	85176200
Country of origin	DE

Technical data

Dimensions

Dimensional drawing	
Width	60 mm
Height	185 mm
Depth	30.5 mm
Drill hole spacing	198.5 mm
Note on dimensions	The height is 212 mm including fixing clips.

Material specifications

Housing material	Pocan®
Color	anthracite

Interfaces

EtherCAT®

No. of channels	2
Connection method	M12 connector
Note on the connection method	D-coded
Number of positions	4
Transmission speed	100 Mbps (with auto negotiation)

EtherCAT®

Equipment type	EtherCAT® slave
System-specific protocols	Mailbox protocols CANopen® over EtherCAT® Mailbox protocols File access over EtherCAT®
Specification	ETG.1000 V1.02

Input data

Digital:

Input name	Digital inputs at pin 2 for class A ports
Description of the input	IEC 61131-2 type 1
Number of inputs	4
Connection method	M12 connector, X01 ... X04 have double occupancy
Connection technology	3-conductor
Input voltage range "0" signal	-0.3 V DC ... 5 V DC
Input voltage range "1" signal	15 V DC ... 30 V DC
Nominal input voltage U_{IN}	24 V DC

2701524

<https://www.phoenixcontact.com/us/products/2701524>

Nominal input current at U_{IN}	typ. 3 mA
Sensor current per channel	max. 200 mA (from L+/L-)
Total sensor current	max. 1.6 A (from L+/L-)
Input frequency	0.5 kHz
Input filter time	< 1000 μ s
Protective circuit	Overload protection, short-circuit protection of sensor supply

Digital

Description of the input	IO-Link ports in digital input (DI) mode
Number of inputs	max. 8 (EN 61131-2 type 1)
Connection method	M12 connector, X01 ... X04 have double occupancy
Connection technology	3-conductor
Nominal input voltage U_{IN}	24 V DC
Input voltage range "0" signal	-0.3 V DC ... 5 V DC
Input voltage range "1" signal	15 V DC ... 30 V DC
Nominal input current	typ. 3 mA
Sensor current per channel	max. 200 mA (from L+/L-)
Total sensor current	max. 1.6 A (from L+/L-)
Input filter time	< 1000 μ s
Input frequency	0.5 kHz
Protective circuit	Overload protection; yes Short-circuit protection for the sensor supply; yes

IO-Link

Number of ports	4
Connection method	M12 connector
Connection technology	3-conductor
Port type	Class A
Cycle Time	min. 2 ms (MasterCycleTime: PDInput* + PDOutput* + OnReqData* <= 17 Bytes, COM3; * see "IO-Link Interface and System Specification V1.1.2")

IO-Link

Number of ports	4
Connection method	M12 connector
Connection technology	3-conductor
Port type	Class B
Cycle Time	min. 2 ms (MasterCycleTime: PDInput* + PDOutput* + OnReqData* <= 17 Bytes, COM3; * see "IO-Link Interface and System Specification V1.1.2")

Output data

Digital

Output description	IO-Link ports in digital output (DO) mode
Connection method	M12 connector, X01 ... X04 have double occupancy
Connection technology	3-conductor

AXL E EC IOL8 DI4 M12 6P - Communication module



2701524

<https://www.phoenixcontact.com/us/products/2701524>

Number of outputs	max. 8
Nominal output voltage	24 V DC
Maximum output current per channel	150 mA
Maximum output current per module	1.2 A
Nominal load, ohmic	3.6 W (160 Ω, at nominal load)
Nominal load, inductive	3.6 VA (0.8 H, 160 Ω, at nominal load)
Signal delay	max. 150 μs (when switched on) max. 200 μs (when switched off)
Switching rate	1 per second, maximum (at nominal inductive load) 5500 per second, maximum (at nominal ohmic load)
Limitation of the voltage induced on circuit interruption	-15 V DC
Output voltage when switched off	max. 1 V
Output current when switched off	max. 300 μA
Protective circuit	Overload protection; yes Short-circuit protection; yes
Behavior with overload	Shutdown with automatic restart

Product properties

Product type	I/O component
Product family	Axioline E
Type	Stand-Alone
Special properties	Plastic housing

Electrical properties

Potentials

Voltage supply U_S	24 V DC
Power supply at U_S	max. 4 A
Current consumption from U_S	typ. 8 mA max. 1.2 A

Supply: IO-Link

Nominal voltage for I/O supply	24 V DC
Nominal current for every IO-Link port	max. 150 mA (at C/Q (pin 4), maximum of 1.6 A over all 8 IO-Link C/Q and L+ cables) max. 200 mA (at L+/L- (pin 1 and pin 3), during startup, up to 1.6 A for short periods) max. 2 A (at U_A (IO-Link B ports, pin 2 and pin 5))
Permissible cable length	< 20 m (to the sensor)
Protective circuit	Overload protection; yes

Supply: Module electronics and sensors

Designation	Supply of module electronics and sensors (U_S)
Connection method	M12 connector (T-coded)
Number of positions	4
Supply voltage	24 V DC

AXL E EC IOL8 DI4 M12 6P - Communication module



2701524

<https://www.phoenixcontact.com/us/products/2701524>

Supply voltage range	19.5 V DC ... 31.2 V DC (including all tolerances, including ripple)
Current consumption	typ. 180 mA \pm 15 % (at 24 V DC) max. 12 A

Supply: Actuators

Designation	Supply of actuators (U_A)
Connection method	M12 connector (T-coded)
Number of positions	4
Supply voltage	24 V DC
Supply voltage range	18 V DC ... 31.2 V DC (including all tolerances, including ripple)
Current consumption	typ. 28 mA \pm 15 % (at 24 V DC) max. 12 A

Electrical isolation/isolation of the voltage ranges

Test voltage: 24 V supply (communications power and sensor supply, IO-Link ports)/bus connection (Ethernet 1)	500 V AC, 50 Hz, 1 min.
Test voltage: 24 V supply (communications power and sensor supply, IO-Link ports)/bus connection (Ethernet 2)	500 V AC, 50 Hz, 1 min.
Test voltage: 24 V supply (communications power and sensor supply, IO-Link ports)/FE	500 V AC, 50 Hz, 1 min.
Test voltage: Bus connection (Ethernet 1)/FE	500 V AC, 50 Hz, 1 min.
Test voltage: Bus connection (Ethernet 2)/FE	500 V AC, 50 Hz, 1 min.
Test voltage: Bus connection (Ethernet 1)/bus connection (Ethernet 2)	500 V AC, 50 Hz, 1 min.
Test voltage: 24 V supply (actuator supply)/24 V supply (communications power and sensor supply, IO-Link ports)	500 V AC, 50 Hz, 1 min.
Test voltage: 24 V supply (actuator supply)/bus connection (Ethernet 1)	500 V AC, 50 Hz, 1 min.
Test voltage: 24 V supply (actuator supply)/bus connection (Ethernet 2)	500 V AC, 50 Hz, 1 min.
Test voltage: 24 V supply (actuator supply)/FE	500 V AC, 50 Hz, 1 min.

Connection data

Connection method	M12 connector
-------------------	---------------

Environmental and real-life conditions

Ambient conditions

Ambient temperature (operation)	-25 °C ... 60 °C
Degree of protection	IP65/IP67
Air pressure (operation)	70 kPa ... 106 kPa (up to 3000 m above sea level)
Air pressure (storage/transport)	70 kPa ... 106 kPa (up to 3000 m above sea level)
Ambient temperature (storage/transport)	-25 °C ... 85 °C
Permissible humidity (operation)	5 % ... 95 %
Permissible humidity (storage/transport)	5 % ... 95 %

Standards and regulations

Protection class	III (IEC 61140, EN 61140, VDE 0140-1)
------------------	---------------------------------------

AXL E EC IOL8 DI4 M12 6P - Communication module



2701524

<https://www.phoenixcontact.com/us/products/2701524>

Drawings

Dimensional drawing

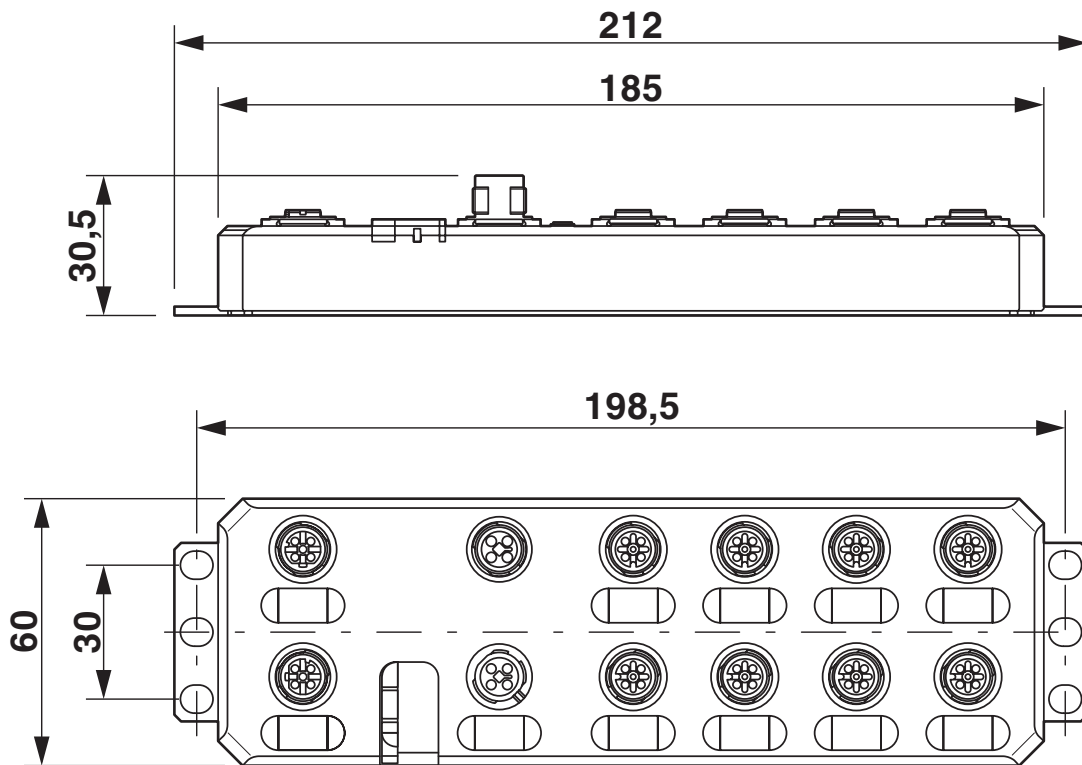

Connection diagram

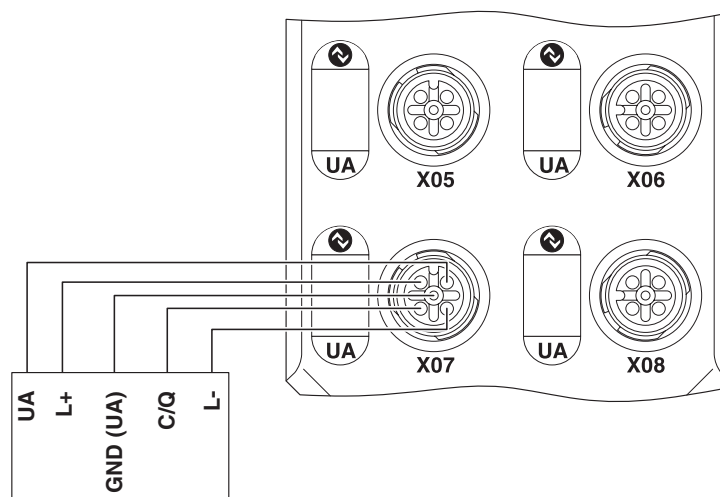

AXL E EC IOL8 DI4 M12 6P - Communication module



2701524

<https://www.phoenixcontact.com/us/products/2701524>

Connection diagram

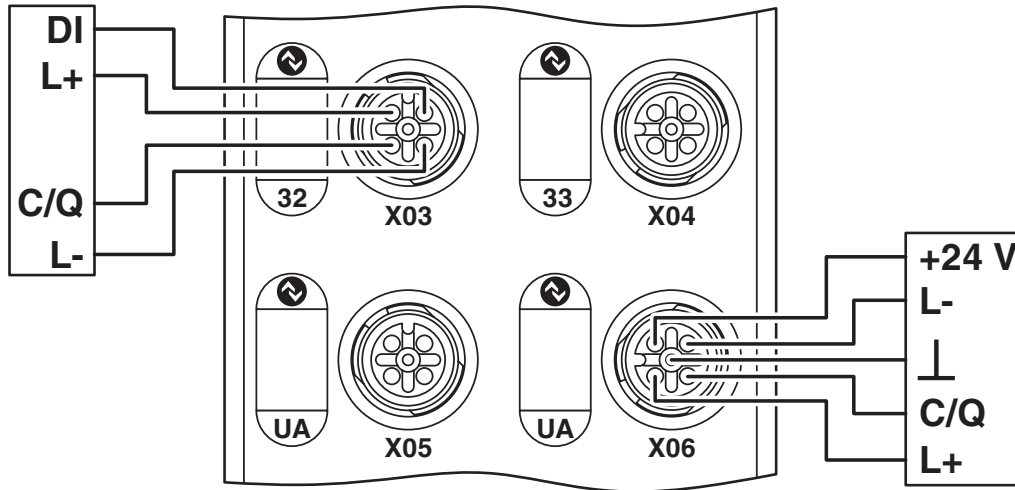



2701524

<https://www.phoenixcontact.com/us/products/2701524>

Approvals

🔗 To download certificates, visit the product detail page: <https://www.phoenixcontact.com/us/products/2701524>

 **UL Listed**
Approval ID: FILE E 140324

 **cUL Listed**
Approval ID: FILE E 140324

 **EtherCAT**
Approval ID: 0x84_002

 **cUL Listed**
Approval ID: FILE E 199827

 **UL Listed**
Approval ID: FILE E 199827

cULus Listed

cULus Listed

AXL E EC IOL8 DI4 M12 6P - Communication module



2701524

<https://www.phoenixcontact.com/us/products/2701524>

Classifications

ECLASS

ECLASS-11.0	27242604
ECLASS-12.0	27242604
ECLASS-13.0	27242604

ETIM

ETIM 9.0	EC001599
----------	----------

UNSPSC

UNSPSC 21.0	32151600
-------------	----------

2701524

<https://www.phoenixcontact.com/us/products/2701524>

Environmental product compliance

EU RoHS

Fulfills EU RoHS substance requirements	Yes
Exemption	6(c)

China RoHS

Environment friendly use period (EFUP)	EFUP-25
	An article-related China RoHS declaration table can be found in the download area for the respective article under "Manufacturer declaration". For all articles with EFUP-E, no China RoHS declaration table issued and required.

EU REACH SVHC

REACH candidate substance (CAS No.)	Lead(CAS: 7439-92-1)
-------------------------------------	----------------------

2701524

<https://www.phoenixcontact.com/us/products/2701524>

Accessories

PROT-M12 - Screw plug

1680539

<https://www.phoenixcontact.com/us/products/1680539>



An M12 screw plug for the unoccupied M12 sockets of the sensor/actuator cable, boxes and flush-type connectors

SACC-M12MSD-4CON-PG 9-SH - Data connector

1521261

<https://www.phoenixcontact.com/us/products/1521261>



Data connector, Ethernet CAT5 (100 Mbps), 4-position, shielded, Plug straight M12, coding: D, Screw connection, knurl material: Brass, nickel-plated, cable gland Pg9, external cable diameter 6 mm ... 8 mm

AXL E EC IOL8 DI4 M12 6P - Communication module



2701524

<https://www.phoenixcontact.com/us/products/2701524>

UCT-EM (7X10) - Snap-in markers

0830765

<https://www.phoenixcontact.com/us/products/0830765>



Snap-in markers, Sheet, white, unlabeled, can be labeled with: TOPMARK NEO, TOPMARK LASER, BLUEMARK ID COLOR, BLUEMARK ID, BLUEMARK CLED, THERMOMARK PRIME, THERMOMARK CARD 2.0, THERMOMARK CARD, mounting type: snapped, lettering field size: 7 x 10 mm, Number of individual labels: 30

SAC-4P- 1,5-PUR/M12FRT SH - Power cable

1424116

<https://www.phoenixcontact.com/us/products/1424116>



Power cable, 4-position, PUR halogen-free, black RAL 9005, shielded (Advanced Shielding Technology), free cable end, on Socket angled M12, coding: T, cable length: 1.5 m, For direct current up to 12 A/63 V

AXL E EC IOL8 DI4 M12 6P - Communication module



2701524

<https://www.phoenixcontact.com/us/products/2701524>

SAC-4P-M12MST/ 1,5-PUR SH - Power cable

1424120

<https://www.phoenixcontact.com/us/products/1424120>



Power cable, 4-position, PUR halogen-free, black RAL 9005, shielded (Advanced Shielding Technology), Plug straight M12, coding: T, on free cable end, cable length: 1.5 m, For direct current up to 12 A/63 V

NBC-M12MSD-PN/.../... - Network cable

1408640

<https://www.phoenixcontact.com/us/products/1408640>



Network cable, PROFINET CAT5 (100 Mbps), EtherCAT® CAT5 (100 Mbps), 4-position, shielded (Advanced Shielding Technology), Plug straight M12, coding: D / IP67, on free cable end, cable length: Free input (0.2 ... 40.0 m)

AXL E EC IOL8 DI4 M12 6P - Communication module



2701524

<https://www.phoenixcontact.com/us/products/2701524>

NBC-M12MSD-M12FSD-PN/.../... - Network cable

1408617

<https://www.phoenixcontact.com/us/products/1408617>



Network cable, PROFINET CAT5 (100 Mbps), EtherCAT® CAT5 (100 Mbps), 4-position, shielded (Advanced Shielding Technology), Plug straight M12, coding: D / IP67, on Socket straight M12, coding: D / IP67, cable length: Free input (0.2 .. 40.0 m)

NBC-M12MSD-M12MSD-PN/.../... - Network cable

1408634

<https://www.phoenixcontact.com/us/products/1408634>



Network cable, PROFINET CAT5 (100 Mbps), EtherCAT® CAT5 (100 Mbps), 4-position, shielded (Advanced Shielding Technology), Plug straight M12, coding: D / IP67, on Plug straight M12, coding: D / IP67, cable length: Free input (0.2 ... 40.0 m)

AXL E EC IOL8 DI4 M12 6P - Communication module



2701524

<https://www.phoenixcontact.com/us/products/2701524>

NBC-M12MSD-R4AC-PN/.../... - Network cable

1408639

<https://www.phoenixcontact.com/us/products/1408639>



Network cable, PROFINET CAT5 (100 Mbps), EtherCAT® CAT5 (100 Mbps), 4-position, shielded (Advanced Shielding Technology), Plug straight M12, coding: D / IP67, on Plug straight RJ45 / IP20, cable length: Free input (0.2 ... 40.0 m)

SAC-4P-M12MST/ 1,0-PUR - Power cable

1408812

<https://www.phoenixcontact.com/us/products/1408812>



Power cable, 4-position, PUR halogen-free, black-gray RAL 7021, Plug straight M12, coding: T, on free cable end, cable length: 1 m, For direct current up to 12 A/63 V

AXL E EC IOL8 DI4 M12 6P - Communication module



2701524

<https://www.phoenixcontact.com/us/products/2701524>

SAC-4P-M12MST/ 2,0-PUR - Power cable

1408813

<https://www.phoenixcontact.com/us/products/1408813>



Power cable, 4-position, PUR halogen-free, black-gray RAL 7021, Plug straight M12, coding: T, on free cable end, cable length: 2 m, For direct current up to 12 A/63 V

SAC-4P-M12MST/ 5,0-PUR - Power cable

1408814

<https://www.phoenixcontact.com/us/products/1408814>



Power cable, 4-position, PUR halogen-free, black-gray RAL 7021, Plug straight M12, coding: T, on free cable end, cable length: 5 m, For direct current up to 12 A/63 V

AXL E EC IOL8 DI4 M12 6P - Communication module



2701524

<https://www.phoenixcontact.com/us/products/2701524>

SAC-4P-M12MST/10,0-PUR - Power cable

1408815

<https://www.phoenixcontact.com/us/products/1408815>



Power cable, 4-position, PUR halogen-free, black-gray RAL 7021, Plug straight M12, coding: T, on free cable end, cable length: 10 m, For direct current up to 12 A/63 V

SAC-4P-M12MRT/ 1,0-PUR - Power cable

1408816

<https://www.phoenixcontact.com/us/products/1408816>



Power cable, 4-position, PUR halogen-free, black-gray RAL 7021, Plug angled M12, coding: T, on free cable end, cable length: 1 m, For direct current up to 12 A/63 V

AXL E EC IOL8 DI4 M12 6P - Communication module



2701524

<https://www.phoenixcontact.com/us/products/2701524>

SAC-4P-M12MRT/ 2,0-PUR - Power cable

1408819

<https://www.phoenixcontact.com/us/products/1408819>



Power cable, 4-position, PUR halogen-free, black-gray RAL 7021, Plug angled M12, coding: T, on free cable end, cable length: 2 m, For direct current up to 12 A/63 V

SAC-4P-M12MRT/ 5,0-PUR - Power cable

1408820

<https://www.phoenixcontact.com/us/products/1408820>



Power cable, 4-position, PUR halogen-free, black-gray RAL 7021, Plug angled M12, coding: T, on free cable end, cable length: 5 m, For direct current up to 12 A/63 V

AXL E EC IOL8 DI4 M12 6P - Communication module



2701524

<https://www.phoenixcontact.com/us/products/2701524>

SAC-4P-M12MRT/10,0-PUR - Power cable

1408822

<https://www.phoenixcontact.com/us/products/1408822>



Power cable, 4-position, PUR halogen-free, black-gray RAL 7021, Plug angled M12, coding: T, on free cable end, cable length: 10 m, For direct current up to 12 A/63 V

SAC-4P- 1,0-PUR/M12FST - Power cable

1408823

<https://www.phoenixcontact.com/us/products/1408823>



Power cable, 4-position, PUR halogen-free, black-gray RAL 7021, free cable end, on Socket straight M12, coding: T, cable length: 1 m, For direct current up to 12 A/63 V

AXL E EC IOL8 DI4 M12 6P - Communication module



2701524

<https://www.phoenixcontact.com/us/products/2701524>

SAC-4P- 2,0-PUR/M12FST - Power cable

1408824

<https://www.phoenixcontact.com/us/products/1408824>



Power cable, 4-position, PUR halogen-free, black-gray RAL 7021, free cable end, on Socket straight M12, coding: T, cable length: 2 m, For direct current up to 12 A/63 V

SAC-4P- 5,0-PUR/M12FST - Power cable

1408825

<https://www.phoenixcontact.com/us/products/1408825>



Power cable, 4-position, PUR halogen-free, black-gray RAL 7021, free cable end, on Socket straight M12, coding: T, cable length: 5 m, For direct current up to 12 A/63 V

AXL E EC IOL8 DI4 M12 6P - Communication module



2701524

<https://www.phoenixcontact.com/us/products/2701524>

SAC-4P-10,0-PUR/M12FST - Power cable

1408826

<https://www.phoenixcontact.com/us/products/1408826>



Power cable, 4-position, PUR halogen-free, black-gray RAL 7021, free cable end, on Socket straight M12, coding: T, cable length: 10 m, For direct current up to 12 A/63 V

SAC-4P- 1,0-PUR/M12FRT - Power cable

1408827

<https://www.phoenixcontact.com/us/products/1408827>



Power cable, 4-position, PUR halogen-free, black-gray RAL 7021, free cable end, on Socket angled M12, coding: T, cable length: 1 m, For direct current up to 12 A/63 V

AXL E EC IOL8 DI4 M12 6P - Communication module



2701524

<https://www.phoenixcontact.com/us/products/2701524>

SAC-4P- 2,0-PUR/M12FRT - Power cable

1408828

<https://www.phoenixcontact.com/us/products/1408828>



Power cable, 4-position, PUR halogen-free, black-gray RAL 7021, free cable end, on Socket angled M12, coding: T, cable length: 2 m, For direct current up to 12 A/63 V

SAC-4P- 5,0-PUR/M12FRT - Power cable

1408829

<https://www.phoenixcontact.com/us/products/1408829>



Power cable, 4-position, PUR halogen-free, black-gray RAL 7021, free cable end, on Socket angled M12, coding: T, cable length: 5 m, For direct current up to 12 A/63 V

AXL E EC IOL8 DI4 M12 6P - Communication module



2701524

<https://www.phoenixcontact.com/us/products/2701524>

SAC-4P-10,0-PUR/M12FRT - Power cable

1408830

<https://www.phoenixcontact.com/us/products/1408830>



Power cable, 4-position, PUR halogen-free, black-gray RAL 7021, free cable end, on Socket angled M12, coding: T, cable length: 10 m, For direct current up to 12 A/63 V

SAC-4P-M12MST/ 0,3-PUR/M12FST - Power cable

1408806

<https://www.phoenixcontact.com/us/products/1408806>



Power cable, 4-position, PUR halogen-free, black-gray RAL 7021, Plug straight M12, coding: T, on Socket straight M12, coding: T, cable length: 0.3 m, For direct current up to 12 A/63 V

AXL E EC IOL8 DI4 M12 6P - Communication module



2701524

<https://www.phoenixcontact.com/us/products/2701524>

SAC-4P-M12MST/ 0,6-PUR/M12FST - Power cable

1408807

<https://www.phoenixcontact.com/us/products/1408807>



Power cable, 4-position, PUR halogen-free, black-gray RAL 7021, Plug straight M12, coding: T, on Socket straight M12, coding: T, cable length: 0.6 m, For direct current up to 12 A/63 V

SAC-4P-M12MST/ 1,0-PUR/M12FST - Power cable

1408808

<https://www.phoenixcontact.com/us/products/1408808>



Power cable, 4-position, PUR halogen-free, black-gray RAL 7021, Plug straight M12, coding: T, on Socket straight M12, coding: T, cable length: 1 m, For direct current up to 12 A/63 V

AXL E EC IOL8 DI4 M12 6P - Communication module



2701524

<https://www.phoenixcontact.com/us/products/2701524>

SAC-4P-M12MST/ 2,0-PUR/M12FST - Power cable

1408809

<https://www.phoenixcontact.com/us/products/1408809>



Power cable, 4-position, PUR halogen-free, black-gray RAL 7021, Plug straight M12, coding: T, on Socket straight M12, coding: T, cable length: 2 m, For direct current up to 12 A/63 V

SAC-4P-M12MST/ 5,0-PUR/M12FST - Power cable

1408810

<https://www.phoenixcontact.com/us/products/1408810>



Power cable, 4-position, PUR halogen-free, black-gray RAL 7021, Plug straight M12, coding: T, on Socket straight M12, coding: T, cable length: 5 m, For direct current up to 12 A/63 V

AXL E EC IOL8 DI4 M12 6P - Communication module



2701524

<https://www.phoenixcontact.com/us/products/2701524>

SAC-4P-M12MST/10,0-PUR/M12FST - Power cable

1408811

<https://www.phoenixcontact.com/us/products/1408811>



Power cable, 4-position, PUR halogen-free, black-gray RAL 7021, Plug straight M12, coding: T, on Socket straight M12, coding: T, cable length: 10 m, For direct current up to 12 A/63 V

SAC-3P-M12MS/.../... - Sensor/actuator cable

1696662

<https://www.phoenixcontact.com/us/products/1696662>



Sensor/actuator cable, 3-position, Plug straight M12, coding: A, on free cable end, cable length: Free input (0.2 ... 40.0 m)

AXL E EC IOL8 DI4 M12 6P - Communication module



2701524

<https://www.phoenixcontact.com/us/products/2701524>

SAC-3P-M12MR/.../... - Sensor/actuator cable

1696675

<https://www.phoenixcontact.com/us/products/1696675>



Sensor/actuator cable, 3-position, Plug angled M12, coding: A, on free cable end, cable length: Free input (0.2 ... 40.0 m)

SAC-3P-M12MS-M12FS/.../... - Sensor/actuator cable

1696756

<https://www.phoenixcontact.com/us/products/1696756>



Sensor/actuator cable, 3-position, Plug straight M12, coding: A, on Socket straight M12, coding: A, cable length: Free input (0.2 ... 40.0 m)

AXL E EC IOL8 DI4 M12 6P - Communication module



2701524

<https://www.phoenixcontact.com/us/products/2701524>

SAC-3P-M12MR-M12FS/.../... - Sensor/actuator cable

1513428

<https://www.phoenixcontact.com/us/products/1513428>



Sensor/actuator cable, 3-position, Plug angled M12, coding: A, on Socket straight M12, coding: A, cable length: Free input (0.2 ... 40.0 m)

SAC-3P-M12MR-M12FR/.../... - Sensor/actuator cable

1513318

<https://www.phoenixcontact.com/us/products/1513318>



Sensor/actuator cable, 3-position, Plug angled M12, coding: A, on Socket angled M12, coding: A, cable length: Free input (0.2 ... 40.0 m)

AXL E EC IOL8 DI4 M12 6P - Communication module



2701524

<https://www.phoenixcontact.com/us/products/2701524>

SAC-4P-M12MR-M12FS/.../... - Sensor/actuator cable

1697030

<https://www.phoenixcontact.com/us/products/1697030>



Sensor/actuator cable, 4-position, Plug angled M12, coding: A, on Socket straight M12, coding: A, cable length: Free input (0.2 ... 40.0 m)

SAC-4P-M12MR-M12FR/.../... - Sensor/actuator cable

1697043

<https://www.phoenixcontact.com/us/products/1697043>



Sensor/actuator cable, 4-position, Plug angled M12, coding: A, on Socket angled M12, coding: A, cable length: Free input (0.2 ... 40.0 m)

AXL E EC IOL8 DI4 M12 6P - Communication module



2701524

<https://www.phoenixcontact.com/us/products/2701524>

SAC-5P-M12MS/.../... - Sensor/actuator cable

1697098

<https://www.phoenixcontact.com/us/products/1697098>



Sensor/actuator cable, 5-position, Plug straight M12, coding: A, on free cable end, cable length: Free input (0.2 ... 40.0 m)

SAC-5P-M12MR/.../... - Sensor/actuator cable

1697108

<https://www.phoenixcontact.com/us/products/1697108>



Sensor/actuator cable, 5-position, Plug angled M12, coding: A, on free cable end, cable length: Free input (0.2 ... 40.0 m)

AXL E EC IOL8 DI4 M12 6P - Communication module



2701524

<https://www.phoenixcontact.com/us/products/2701524>

SAC-5P-M12MR-M12FS/.../... - Sensor/actuator cable

1508734

<https://www.phoenixcontact.com/us/products/1508734>



Sensor/actuator cable, 5-position, Plug angled M12, coding: A, on Socket straight M12, coding: A, cable length: Free input (0.2 ... 40.0 m)

SAC-5P-M12MR-M12FR/.../... - Sensor/actuator cable

1529506

<https://www.phoenixcontact.com/us/products/1529506>



Sensor/actuator cable, 5-position, Plug angled M12, coding: A, on Socket angled M12, coding: A, cable length: Free input (0.2 ... 40.0 m)

AXL E EC IOL8 DI4 M12 6P - Communication module



2701524

<https://www.phoenixcontact.com/us/products/2701524>

SAC-3P-Y/2XM 8FS SCO - Y distributor

1523984

<https://www.phoenixcontact.com/us/products/1523984>



Y distributor, 4-position, Plug straight M12 SPEEDCON, coding: A, on Socket straight M8, coding: A and Socket straight M8, coding: A

SAC-3P-Y/2XFS PE SCO - Y distributor

1523971

<https://www.phoenixcontact.com/us/products/1523971>



Y distributor, 4-position, Plug straight M12 SPEEDCON, coding: A, on Socket straight M12 SPEEDCON, coding: A and Socket straight M12 SPEEDCON, coding: A

AXL E EC IOL8 DI4 M12 6P - Communication module



2701524

<https://www.phoenixcontact.com/us/products/2701524>

SAC-3P-Y/2XFS B PE SCO - Y distributor

1523968

<https://www.phoenixcontact.com/us/products/1523968>



Y distributor, 4-position, Plug straight M12 SPEEDCON, coding: A, on Socket straight M12 SPEEDCON, coding: A, PIN 2+4 bridged and Socket straight M12 SPEEDCON, coding: A, PIN 2+4 bridged, Thread M12 socket not rotatable

PROT-M12 SH - Screw plug

1503302

<https://www.phoenixcontact.com/us/products/1503302>



An M12 screw plug for the unoccupied M12 sockets of the shielded sensor/actuator cable, boxes and flush-type connectors

Phoenix Contact 2024 © - all rights reserved
<https://www.phoenixcontact.com>

Phoenix Contact USA
586 Fulling Mill Road
Middletown, PA 17057, United States
(+717) 944-1300
info@phoenixcon.com