

# SAC-5P-MS/1,5-542/ FRSH SCO BK - Sensor/actuator cable



1406134

<https://www.phoenixcontact.com/us/products/1406134>

Please be informed that the data shown in this PDF document is generated from our online catalog. Please find the complete data in the user documentation. Our general terms of use for downloads are valid.



Sensor/actuator cable, 5-position, PVC, yellow, shielded, Plug straight M12, coding: A, on Socket angled M12, coding: A, cable length: 1.5 m

## Commercial data

Item number	1406134
Packing unit	1 pc
Minimum order quantity	1 pc
Note	Made to order (non-returnable)
Sales key	BF13
Product key	BF1IDC
GTIN	4046356799157
Weight per piece (including packing)	112.6 g
Weight per piece (excluding packing)	112.6 g
Customs tariff number	85444290
Country of origin	US

# SAC-5P-MS/1,5-542/ FRSH SCO BK - Sensor/actuator cable



1406134

<https://www.phoenixcontact.com/us/products/1406134>

## Technical data

### Product properties

Product type	Sensor/actuator cable
Application	Standard, U.S. cables
Number of positions	5
No. of cable outlets	1
Shielded	yes
Coding	A

### Insulation characteristics

Overvoltage category	II
Degree of pollution	3

### Material specifications

Flammability rating according to UL 94	HB
Seal material	NBR
Material of grip body	TPU, hardly inflammable, self-extinguishing
Contact material	CuSn
Contact surface material	Ni/Au
Contact carrier material	TPU GF
Material for screw connection	Zinc die-cast, nickel-plated
Outer sheath, material	PVC

### Electrical properties

Insulation resistance	$\geq 100 \text{ M}\Omega$
Nominal voltage $U_N$	48 V AC
	60 V DC
Nominal current $I_N$	4 A

### Mechanical properties

#### Mechanical data

Insertion/withdrawal cycles	$\geq 100$
-----------------------------	------------

### Signaling

Status display	No
Status display present	No

### Connection data

#### Conductor connection

Tightening torque	0.4 Nm (M12 connector)
-------------------	------------------------

### Connector

# SAC-5P-MS/1,5-542/ FRSH SCO BK - Sensor/actuator cable



1406134

<https://www.phoenixcontact.com/us/products/1406134>

## Connection 1

Type	Plug straight M12
Number of positions	5
Coding type	A

## Connection 2

Type	Socket angled M12
Number of positions	5
Coding type	A

## Cable/line

Cable length	1.5 m
--------------	-------

## PVC yellow 105 °C [542]

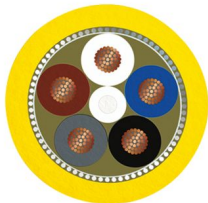
Dimensional drawing	
Cable weight	57 kg/km
UL AWM Style	2517 (105 °C / 300 V)
Number of positions	5
Shielded	yes
Cable type	PVC yellow 105 °C [542]
Conductor structure signal line	30x 1.30 mm
AWG signal line	22
Wire diameter incl. insulation	1.27 mm ±0.03 mm
External cable diameter	5.90 mm ±0.2 mm
Outer sheath, material	PVC
External sheath, color	yellow
Conductor material	Tin-plated Cu litz wires
Material, filler	PP
Material wire insulation	PVC
Single wire, color	brown, blue, black, white, gray
Overall twist	5 wires around filler to the core
Optical shield covering	85 %
Max. conductor resistance	max. 50.5 Ω/km (20 °C)
Insulation resistance	≥ (550 M Ohms/m @ 500V)
Nominal voltage, cable	300 V
Minimum bending radius, flexible installation	12 x D
Smallest bending radius, movable installation	71 mm

# SAC-5P-MS/1,5-542/ FRSH SCO BK - Sensor/actuator cable



1406134

<https://www.phoenixcontact.com/us/products/1406134>

Flame resistance	FT4
Other resistance	UV resistant
Special properties	UL standards PLTC and ITC
Ambient temperature (operation)	-30 °C ... 105 °C (cable, fixed installation)
	-5 °C ... 105 °C (Cable, flexible installation)

## Environmental and real-life conditions

### Ambient conditions

Degree of protection	IP65
	IP67
Ambient temperature (operation)	-25 °C ... 90 °C (Plug / socket)
	-25 °C ... 80 °C (cable, fixed installation)
	-5 °C ... 80 °C (Cable, flexible installation)

## Standards and regulations

Standard designation	M12 connector
Standards/specifications	IEC 61076-2-101

1406134

<https://www.phoenixcontact.com/us/products/1406134>

### Drawings

Circuit diagram

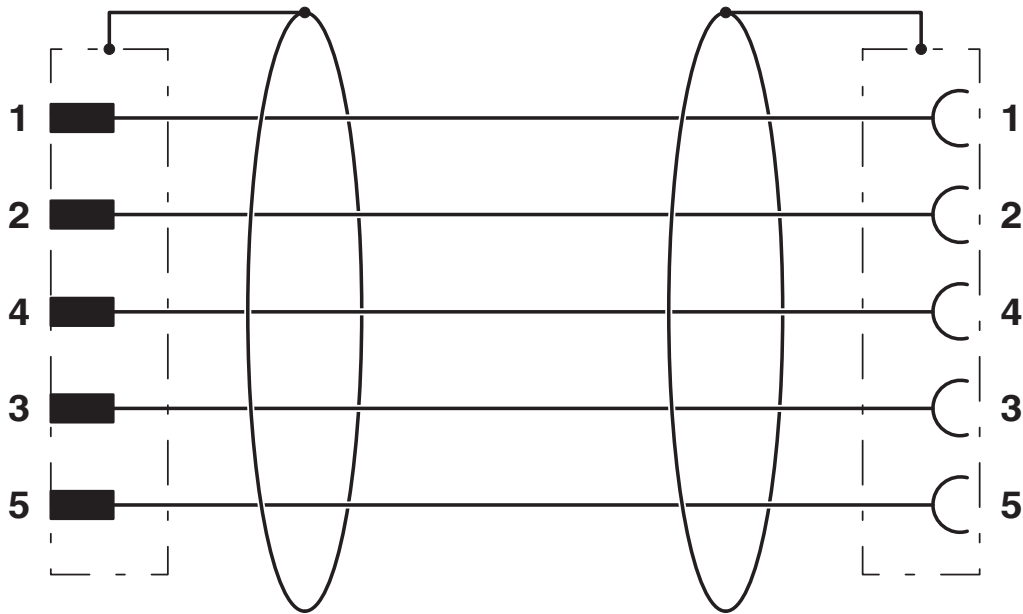

Schematic diagram

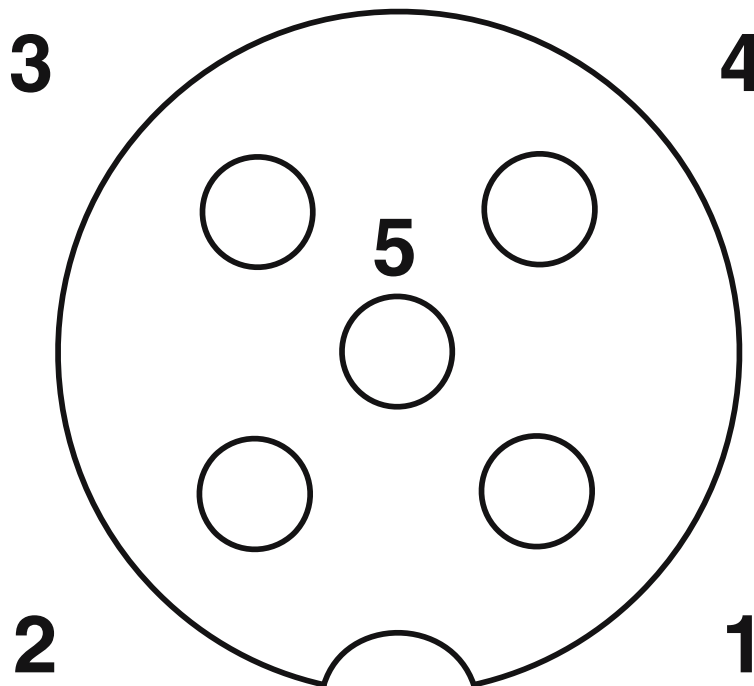

Pin assignment M12 socket, 5-pos., A-coded, socket side view

# SAC-5P-MS/1,5-542/ FRSH SCO BK - Sensor/actuator cable

1406134

<https://www.phoenixcontact.com/us/products/1406134>

Dimensional drawing

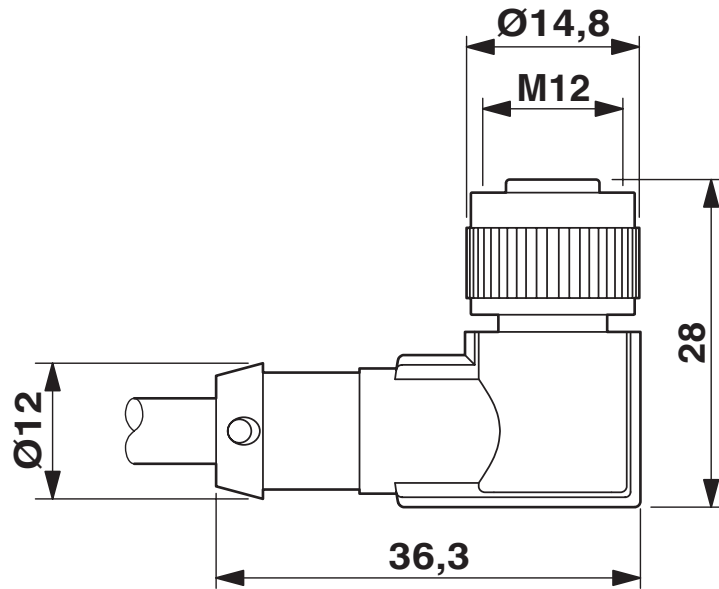

M12 x 1 socket, angled, shielded

Schematic diagram

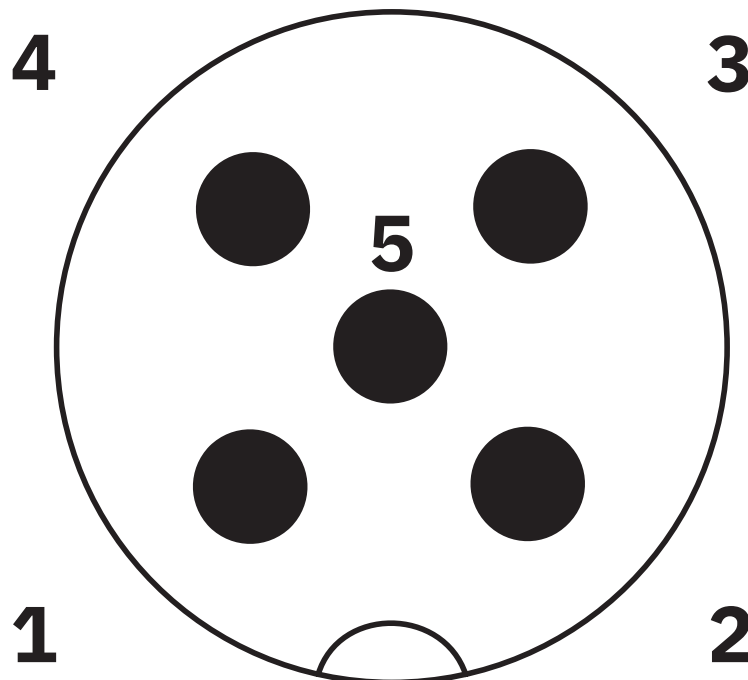

Pin assignment M12 male connector, 5-pos., A-coded, male side

# SAC-5P-MS/1,5-542/ FRSH SCO BK - Sensor/actuator cable

1406134

<https://www.phoenixcontact.com/us/products/1406134>

Dimensional drawing

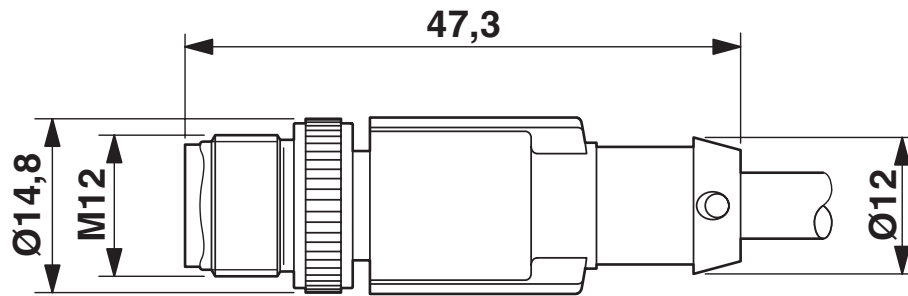

Plug, M12 x 1, straight, shielded

# SAC-5P-MS/1,5-542/ FRSH SCO BK - Sensor/actuator cable



1406134

<https://www.phoenixcontact.com/us/products/1406134>

## Approvals

To download certificates, visit the product detail page: <https://www.phoenixcontact.com/us/products/1406134>

 <b>UL Listed</b> Approval ID: FILE E 221474				
	Nominal voltage $U_N$	Nominal current $I_N$	Cross section AWG	Cross section $\text{mm}^2$
	125 V	4 A	-	-

 <b>cUL Listed</b> Approval ID: FILE E 221474				
	Nominal voltage $U_N$	Nominal current $I_N$	Cross section AWG	Cross section $\text{mm}^2$
	125 V	4 A	-	-

 <b>EAC-RoHS</b> Approval ID: RU D-DE.HB35.B.00387	
-----------------------------------------------------------------------------------------------------------------------------------------	--

<b>cULus Listed</b>
---------------------

# SAC-5P-MS/1,5-542/ FRSH SCO BK - Sensor/actuator cable



1406134

<https://www.phoenixcontact.com/us/products/1406134>

## Classifications

### ECLASS

ECLASS-11.0	27060311
ECLASS-12.0	27060311
ECLASS-13.0	27060311

### ETIM

ETIM 9.0	EC001855
----------	----------

### UNSPSC

UNSPSC 21.0	26121600
-------------	----------

# SAC-5P-MS/1,5-542/ FRSH SCO BK - Sensor/actuator cable



1406134

<https://www.phoenixcontact.com/us/products/1406134>

## Environmental product compliance

### EU RoHS

Fulfills EU RoHS substance requirements	Yes, No exemptions
-----------------------------------------	--------------------

### China RoHS

Environment friendly use period (EFUP)	EFUP-E
	No hazardous substances above the limits

### EU REACH SVHC

REACH candidate substance (CAS No.)	No substance above 0.1 wt%
-------------------------------------	----------------------------

# SAC-5P-MS/1,5-542/ FRSH SCO BK - Sensor/actuator cable



1406134

<https://www.phoenixcontact.com/us/products/1406134>

## Accessories

### PROT-M12 FS-PA-CHAIN - Sealing cap

1430873

<https://www.phoenixcontact.com/us/products/1430873>

M12 sealing cap made of plastic with fixing band, for sensor cables, for free M12 plugs



---

### SAC-M12-EXCLIP-M - Locking clip

1558988

<https://www.phoenixcontact.com/us/products/1558988>

Locking clip for the pin side of sensor/actuator cables with M12 connector and M12 connectors for assembly, for knurl diameter: 15 mm or for Allen key with a wrench size of 14 mm, prevents the disconnection of plug-in connections without tools



# SAC-5P-MS/1,5-542/ FRSH SCO BK - Sensor/actuator cable



1406134

<https://www.phoenixcontact.com/us/products/1406134>

## PROT-M12 MS-PA-CHAIN - Screw plug

1430899

<https://www.phoenixcontact.com/us/products/1430899>

M12 sealing cap with fixing band, for sensor cables, for free M12 sockets



---

## SAC-M12-EXCLIP-F - Locking clip

1558991

<https://www.phoenixcontact.com/us/products/1558991>

Locking clip for the socket side of sensor/actuator cables with M12 connector and M12 connectors for assembly, for knurl diameter: 15 mm or for Allen key with a wrench size of 14 mm, prevents the disconnection of plug-in connections without tools



# SAC-5P-MS/1,5-542/ FRSH SCO BK - Sensor/actuator cable



1406134

<https://www.phoenixcontact.com/us/products/1406134>

## TSD 04 SAC - Torque screwdriver

1208429

<https://www.phoenixcontact.com/us/products/1208429>



Torque screwdriver, with preset torque of 0.4 Nm and 4 mm hexagonal drive for M12 connectors

---

## TSD-M 1,2NM - Torque screwdriver

1212224

<https://www.phoenixcontact.com/us/products/1212224>



Torque screw driver, accuracy as per EN ISO 6789 standard, adjustable from 0.3 - 1.2 Nm

# SAC-5P-MS/1,5-542/ FRSH SCO BK - Sensor/actuator cable



1406134

<https://www.phoenixcontact.com/us/products/1406134>

## TSD-M SAC-BIT ADAPTER - Adapter insert

1212600

<https://www.phoenixcontact.com/us/products/1212600>



Adapter bit for TSD-M...torque tools, E6.3-1/4" drive with 4 mm hexagon to accommodate SAC bits

---

## SAC BIT M12-D15 - Tool

1208432

<https://www.phoenixcontact.com/us/products/1208432>



Nut for assembling sensor/actuator cables with M12 connector and M12 connectors for assembly, with a knurl diameter of 15 mm, for 4 mm hexagonal drive

---

Phoenix Contact 2024 © - all rights reserved  
<https://www.phoenixcontact.com>

Phoenix Contact USA  
586 Fulling Mill Road  
Middletown, PA 17057, United States  
(+717) 944-1300  
[info@phoenixcon.com](mailto:info@phoenixcon.com)