

SAC-3P- 5,0-PUR/M12FR-2L - Sensor/actuator cable



1694415

<https://www.phoenixcontact.com/us/products/1694415>

Please be informed that the data shown in this PDF document is generated from our online catalog. Please find the complete data in the user documentation. Our general terms of use for downloads are valid.



Sensor/actuator cable, 3-position, PUR halogen-free, black-gray RAL 7021, free cable end, on Socket angled M12, coding: A, with 2 LEDs, cable length: 5 m

Your advantages

- Easy and safe: 100 % electrically tested plug-in components
- Convenient: increased machine availability thanks to quick and easy diagnostics

Commercial data

Item number	1694415
Packing unit	1 pc
Minimum order quantity	1 pc
Sales key	BF03
Product key	BF1CBA
Catalog page	Page 188 (C-2-2019)
GTIN	4017918178284
Weight per piece (including packing)	116.6 g
Weight per piece (excluding packing)	112 g
Customs tariff number	85444290
Country of origin	PL

SAC-3P- 5,0-PUR/M12FR-2L - Sensor/actuator cable



1694415

<https://www.phoenixcontact.com/us/products/1694415>

Technical data

Product properties

Product type	Sensor/actuator cable
Application	Standard
Number of positions	3
No. of cable outlets	1
Shielded	no
Coding	A

Insulation characteristics

Overvoltage category	II
Degree of pollution	3

Material specifications

Flammability rating according to UL 94	HB
Seal material	NBR
Material of grip body	TPU, hardly inflammable, self-extinguishing
Contact material	CuSn
Contact surface material	Ni/Au
Contact carrier material	TPU GF
Material for screw connection	Zinc die-cast, nickel-plated

Electrical properties

Insulation resistance	$\geq 100 \text{ M}\Omega$
Nominal voltage U_N	24 V DC
Nominal current I_N	4 A

Mechanical properties

Mechanical data

Insertion/withdrawal cycles	≥ 100
-----------------------------	------------

Signaling

Status display	2 LEDs
Status display present	Yes

Connection data

Conductor connection

Tightening torque	0.4 Nm (M12 connector)
-------------------	------------------------

Connector

Connection 1

Type	free cable end
------	----------------

SAC-3P- 5,0-PUR/M12FR-2L - Sensor/actuator cable



1694415

<https://www.phoenixcontact.com/us/products/1694415>

Connection 2

Type	Socket angled M12
Number of positions	3
Coding type	A

Cable/line

Cable length	5 m
--------------	-----

PUR halogen-free black [PUR]

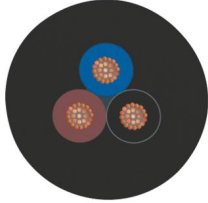
Dimensional drawing	
Cable weight	23 kg/km
UL AWM Style	20549
Number of positions	3
Shielded	no
Cable type	PUR halogen-free black [PUR]
Conductor structure signal line	42x 0.10 mm
AWG signal line	22
Conductor cross section	3x 0.34 mm ² (Signal line)
Wire diameter incl. insulation	1.27 mm ±0.02 mm (Signal line)
External cable diameter	3.85 mm ±0.15 mm
Outer sheath, material	PUR
External sheath, color	black-gray RAL 7021
Conductor material	Bare Cu litz wires
Material wire insulation	PP
Single wire, color	brown, blue, black
Thickness, insulation	≥ 0.21 mm (Core insulation) approx. 0.50 mm (Outer cable sheath)
Overall twist	3 wires, twisted
Max. conductor resistance	max. 58 Ω/km (at 20 °C)
Insulation resistance	≥ 100 GΩ*km (at 20 °C)
Nominal voltage, cable	≤ 300 V
Test voltage	≥ 3000 V
Smallest bending radius, fixed installation	19 mm
Smallest bending radius, movable installation	38 mm
Max. bending cycles	10000000
Bending radius	38 mm
Traversing path	10 m

SAC-3P- 5,0-PUR/M12FR-2L - Sensor/actuator cable



1694415

<https://www.phoenixcontact.com/us/products/1694415>

Traversing rate	3 m/s
Acceleration	10 m/s ²
Halogen-free	in accordance with DIN VDE 0472 part 815
Flame resistance	in accordance with UL 758/1581 FT2 DIN EN 60332-2-2 (20 s)
Resistance to oil	in accordance with DIN EN 60811-2-1
Other resistance	Highly resistant to acids, alkaline solutions and solvents hydrolysis and microbe resistant partly UV-resistant (in accordance with DIN EN ISO 4892-2-A)
Special properties	Flexible cable conduit capable Silicone-free Free of substances which would hinder coating with paint or varnish
Ambient temperature (operation)	-40 °C ... 80 °C (cable, fixed installation) -25 °C ... 80 °C (Cable, flexible installation)

Environmental and real-life conditions

Ambient conditions

Degree of protection	IP65 IP67 IP68
Ambient temperature (operation)	-25 °C ... 90 °C (Plug / socket)

Standards and regulations

Standard designation	M12 connector
Standards/specifications	IEC 61076-2-101

SAC-3P- 5,0-PUR/M12FR-2L - Sensor/actuator cable



1694415

<https://www.phoenixcontact.com/us/products/1694415>

Drawings

Circuit diagram

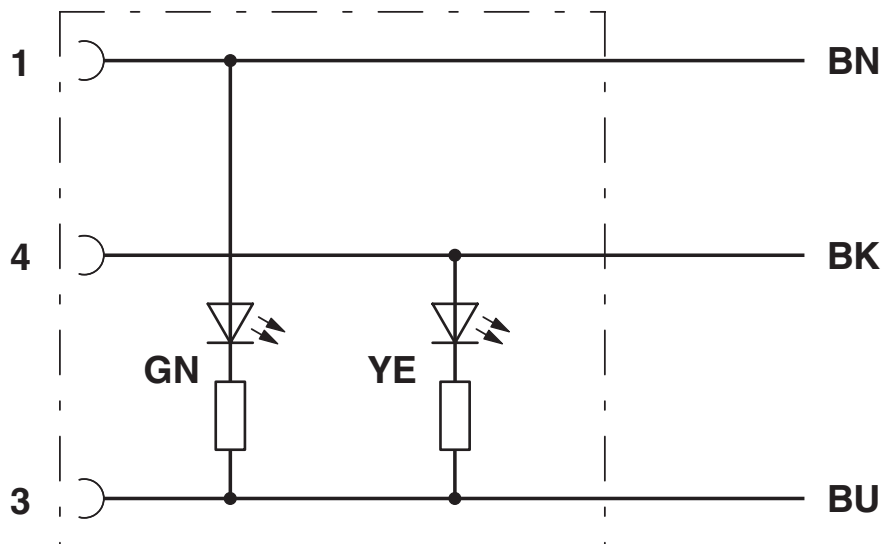

Dimensional drawing

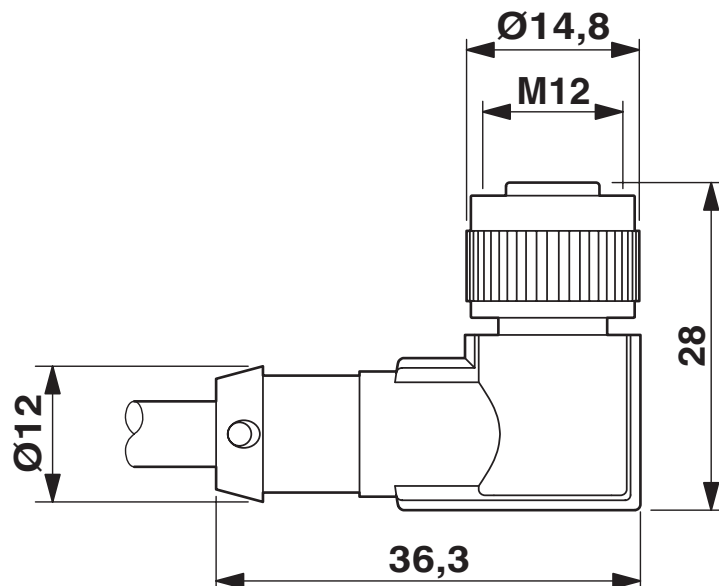

Socket M12 x 1, angled, with LED

1694415

<https://www.phoenixcontact.com/us/products/1694415>

Schematic diagram

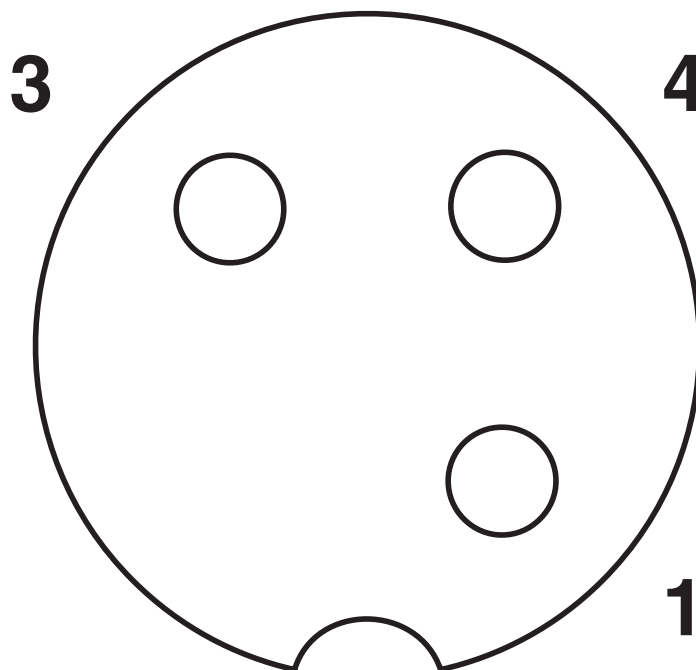

Pin assignment M12 socket, 3-pos., A-coded, view female side

SAC-3P- 5,0-PUR/M12FR-2L - Sensor/actuator cable





1694415

<https://www.phoenixcontact.com/us/products/1694415>

Approvals

To download certificates, visit the product detail page: <https://www.phoenixcontact.com/us/products/1694415>

 UL Listed Approval ID: FILE E 221474	Nominal voltage U_N	Nominal current I_N	Cross section AWG	Cross section mm^2
	24 V	4 A	-	-

 cUL Listed Approval ID: FILE E 221474	Nominal voltage U_N	Nominal current I_N	Cross section AWG	Cross section mm^2
	24 V	4 A	-	-

 EAC-RoHS Approval ID: RU D-DE.HB35.B.00387

cULus Listed

SAC-3P- 5,0-PUR/M12FR-2L - Sensor/actuator cable



1694415

<https://www.phoenixcontact.com/us/products/1694415>

Classifications

ECLASS

ECLASS-11.0	27060311
ECLASS-12.0	27060311
ECLASS-13.0	27060311

ETIM

ETIM 9.0	EC001855
----------	----------

UNSPSC

UNSPSC 21.0	26121600
-------------	----------

SAC-3P- 5,0-PUR/M12FR-2L - Sensor/actuator cable



1694415

<https://www.phoenixcontact.com/us/products/1694415>

Environmental product compliance

EU RoHS

Fulfills EU RoHS substance requirements	Yes, No exemptions
---	--------------------

China RoHS

Environment friendly use period (EFUP)	EFUP-E
	No hazardous substances above the limits

EU REACH SVHC

REACH candidate substance (CAS No.)	No substance above 0.1 wt%
-------------------------------------	----------------------------

1694415

<https://www.phoenixcontact.com/us/products/1694415>

Accessories

UCT-WMT (23X4) - Conductor marker

0801453

<https://www.phoenixcontact.com/us/products/0801453>



Conductor marker, Sheet, white, unlabeled, can be labeled with: TOPMARK NEO, TOPMARK LASER, BLUEMARK ID COLOR, BLUEMARK ID, BLUEMARK CLED, THERMOMARK PRIME, THERMOMARK CARD 2.0, THERMOMARK CARD, mounting type: insert, cable diameter range: 1.5 ... 35 mm, lettering field size: 23 x 4 mm, Number of individual labels: 30

UC-WMT (23X4) - Conductor marker

0819411

<https://www.phoenixcontact.com/us/products/0819411>



Conductor marker, Sheet, white, unlabeled, can be labeled with: BLUEMARK ID COLOR, BLUEMARK ID, BLUEMARK CLED, PLOTMARK, CMS-P1-PLOTTER, mounting type: insert, cable diameter range: 1.5 ... 35 mm, lettering field size: 23 x 4 mm, Number of individual labels: 24

SAC-3P- 5,0-PUR/M12FR-2L - Sensor/actuator cable



1694415

<https://www.phoenixcontact.com/us/products/1694415>

US-WMT (23X4) - Cable marker

0828769

<https://www.phoenixcontact.com/us/products/0828769>



Cable marker, Card, white, unlabeled, can be labeled with: BLUEMARK ID COLOR, BLUEMARK ID, THERMOMARK PRIME, THERMOMARK CARD 2.0, THERMOMARK CARD, mounting type: slide-on, cable diameter range: 1.5 ... 35 mm, lettering field size: 23 x 4 mm, Number of individual labels: 56

WMTW (23X4)R - Cable marker

0831004

<https://www.phoenixcontact.com/us/products/0831004>



Cable marker, Roll, white, unlabeled, can be labeled with: THERMOMARK E.300 (D)/600 (D), THERMOMARK ROLL 2.0, THERMOMARK ROLL, THERMOMARK ROLL X1, THERMOMARK ROLLMASTER 300/600, THERMOMARK X1.2, mounting type: insert, cable diameter range: 1.5 ... 35 mm, lettering field size: 23 x 4 mm, Number of individual labels: 3000

SAC-3P- 5,0-PUR/M12FR-2L - Sensor/actuator cable



1694415

<https://www.phoenixcontact.com/us/products/1694415>

WP-CTA POM 13,0 BK - Protective hose adapter

1422884

<https://www.phoenixcontact.com/us/products/1422884>



Protective hose adapter, for corrugated hoses with a nominal size of 13 (10 x 13), corrugated in parallel

WP-PA HF 13,0 BK - Protective hose

3240681

<https://www.phoenixcontact.com/us/products/3240681>



Protective hose, material: PA 6, UV-resistant: yes, flexible, degree of protection: IP68, color: black, flammability rating in acc. with UL 94: V0, inner diameter: 10 mm, Total length: 50 m

SAC-3P- 5,0-PUR/M12FR-2L - Sensor/actuator cable

1694415

<https://www.phoenixcontact.com/us/products/1694415>



WP-PA HF-HB 13,0 BK - Protective hose

3240839

<https://www.phoenixcontact.com/us/products/3240839>



Protective hose, material: PA 6, UV-resistant: yes, flexible, degree of protection: IP68, color: black, flammability rating in acc. with UL 94: HB, inner diameter: 10 mm, Total length: 50 m

PROT-M12 MS-PA-CHAIN - Screw plug

1430899

<https://www.phoenixcontact.com/us/products/1430899>

M12 sealing cap with fixing band, for sensor cables, for free M12 sockets



SAC-3P- 5,0-PUR/M12FR-2L - Sensor/actuator cable



1694415

<https://www.phoenixcontact.com/us/products/1694415>

SAC-M12-EXCLIP-F - Locking clip

1558991

<https://www.phoenixcontact.com/us/products/1558991>



Locking clip for the socket side of sensor/actuator cables with M12 connector and M12 connectors for assembly, for knurl diameter: 15 mm or for Allen key with a wrench size of 14 mm, prevents the disconnection of plug-in connections without tools

B-STIFT - Marker pen

1051993

<https://www.phoenixcontact.com/us/products/1051993>



Marker pen, for manual labeling of unprinted Zack strips, smear-proof and waterproof, line thickness 0.5 mm

SAC-3P- 5,0-PUR/M12FR-2L - Sensor/actuator cable



1694415

<https://www.phoenixcontact.com/us/products/1694415>

CUTFOX-S VDE - Diagonal cutter

1212207

<https://www.phoenixcontact.com/us/products/1212207>



Diagonal cutter for hard (piano wire) and soft wires, VDE 1000 V AC/1500 V DC tested

WIREFOX SAC-1 - Stripping tool

1212757

<https://www.phoenixcontact.com/us/products/1212757>



Stripping pliers, for halogen-free sensor/actuator cables (SAC cables), with PUR and PVC insulation, from Ø of 3.2 to 4.4 mm, any stripping length

SAC-3P- 5,0-PUR/M12FR-2L - Sensor/actuator cable



1694415

<https://www.phoenixcontact.com/us/products/1694415>

WIREFOX SAC - Stripping tool

1212623

<https://www.phoenixcontact.com/us/products/1212623>



Stripping pliers, for halogen-free sensor/actuator cables (SAC cables), with PUR and PVC insulation, from \varnothing of 4.4 to 7 mm, any stripping length

WIREFOX 10 - Stripping tool

1212150

<https://www.phoenixcontact.com/us/products/1212150>



Stripping tool, for cables and conductors from 0.02 - 10 mm², self-adjusting, stripping length of up to 18 mm, cutting capacity of up to 10 mm² stranded/1.5 mm² solid, replaceable stripping blade

SAC-3P- 5,0-PUR/M12FR-2L - Sensor/actuator cable



1694415

<https://www.phoenixcontact.com/us/products/1694415>

TSD 04 SAC - Torque screwdriver

1208429

<https://www.phoenixcontact.com/us/products/1208429>



Torque screwdriver, with preset torque of 0.4 Nm and 4 mm hexagonal drive for M12 connectors

TSD-M 1,2NM - Torque screwdriver

1212224

<https://www.phoenixcontact.com/us/products/1212224>



Torque screw driver, accuracy as per EN ISO 6789 standard, adjustable from 0.3 - 1.2 Nm

SAC-3P- 5,0-PUR/M12FR-2L - Sensor/actuator cable



1694415

<https://www.phoenixcontact.com/us/products/1694415>

TSD-M SAC-BIT ADAPTER - Adapter insert

1212600

<https://www.phoenixcontact.com/us/products/1212600>



Adapter bit for TSD-M...torque tools, E6.3-1/4" drive with 4 mm hexagon to accommodate SAC bits

SAC BIT M12-D15 - Tool

1208432

<https://www.phoenixcontact.com/us/products/1208432>



Nut for assembling sensor/actuator cables with M12 connector and M12 connectors for assembly, with a knurl diameter of 15 mm, for 4 mm hexagonal drive

Phoenix Contact 2024 © - all rights reserved
<https://www.phoenixcontact.com>

Phoenix Contact USA
586 Fulling Mill Road
Middletown, PA 17057, United States
(+717) 944-1300
info@phoenixcon.com