

PLC-V8L/FLK14/OUT - System connection



2299660

<https://www.phoenixcontact.com/us/products/2299660>

Please be informed that the data shown in this PDF document is generated from our online catalog. Please find the complete data in the user documentation. Our general terms of use for downloads are valid.



V8 adapter for 8 x PLC-INTERFACE (14 mm), controller: PLC system cabling of output cards, connection 1: IDC/FLK pin strip 1x 14-position, connection 2: Plug-in connection (Can be snapped onto 8x PLC-INTERFACE terminals), connection 3: Screw connection 1x 2-position, number of channels: 8, control logic: positive switching

Commercial data

Item number	2299660
Packing unit	1 pc
Minimum order quantity	1 pc
Sales key	C421
Product key	CK21D1
Catalog page	Page 427 (C-5-2019)
GTIN	4017918893163
Weight per piece (including packing)	124.2 g
Weight per piece (excluding packing)	122.8 g
Customs tariff number	85369010
Country of origin	DE

PLC-V8L/FLK14/OUT - System connection



2299660

<https://www.phoenixcontact.com/us/products/2299660>

Technical data

Product properties

Product type	Interface module
Product family	PLC-INTERFACE
Number of positions	14
No. of channels	8

Insulation characteristics

Insulation	Functional insulation
------------	-----------------------

Insulation characteristics: Air clearances and creepage distances

Insulation	Functional insulation
Overvoltage category	II
Pollution degree	2

Electrical properties

Operating voltage range	18 V DC ... 33.6 V DC
Current (per branch)	≤ 1 A
Current (Power supply)	≤ 3 A

Air clearances and creepage distances

Rated insulation voltage	50 V
Rated surge voltage	0.5 kV (1.2/50 μs)

Supported controller SIEMENS S7-1500

Suitable I/O card	6ES7522-1BH00-0AB0
	6ES7522-1BH01-0AB0
	6ES7522-1BL00-0AB0
	6ES7522-1BL01-0AB0
	6ES7522-1BP00-0AA0

Supported controller SIEMENS S7-400

Suitable I/O card	6ES7422-1BL00-0AA0
	6ES7422-1BL00-0AA0

Supported controller ALLEN-BRADLEY ControlLogix

Suitable I/O card	1756-OB32
	1756-OB16E

Supported controller ALLEN-BRADLEY PLC 5

Suitable I/O card	1771 OBN
-------------------	----------

Supported controller ALLEN-BRADLEY SLC 500

Suitable I/O card	1746 OB 32
-------------------	------------

Supported controller HONEYWELL Experion PKS C200

PLC-V8L/FLK14/OUT - System connection



2299660

<https://www.phoenixcontact.com/us/products/2299660>

Suitable I/O card	TC-ODD 321
Supported controller MITSUBISHI MELSEC Q	
Suitable I/O card	QY81P
	QY82P
Supported controller SIEMENS S7-300 / ET 200 M	
Suitable I/O card	CPU 313C-2DP
	CPU 314C-2DP
	CPU 314C-2PtP
	6ES7322-1BH01-0AA0
	6ES7322-1BL00-0AA0
	6ES7323-1BH01-0AA0
	6ES7323-1BL00-0AA0
	CPU 313C
	CPU 313C-2PtP
Supported controller ABB S800 I/O	
Suitable I/O card	DO810
	DO840
Supported controller EMERSON DeltaV	
Suitable I/O card	VE4002S1T1B3
	VE4002S1T2B3
	VE4002S1T2B3 Series 2
	VE4002S1T2B6
Supported controller GE-FANUC RX3i	
Suitable I/O card	IC694MDL754
Supported controller MITSUBISHI MELSEC L	
Suitable I/O card	LY41PT1P
	LY42PT1P

Connection data

Connection 1 (control level)

Connection in acc. with standard	IEC 60603-13
Connection method	IDC/FLK pin strip
Number of connections	1
Number of positions	14
Insertion/withdrawal cycles	> 50
Pitch	2.54 mm

Connection 2 (field level)

Connection method	Plug-in connection
Note	Can be snapped onto 8x PLC-INTERFACE terminals

PLC-V8L/FLK14/OUT - System connection



2299660

<https://www.phoenixcontact.com/us/products/2299660>

Connection 3 (supply)

Connection method	Screw connection
Stripping length	8 mm
Screw thread	M3
Number of connections	1
Number of positions	2
Conductor cross section rigid	0.2 mm ² ... 4 mm ²
Conductor cross-section rigid (2 conductors with same cross section)	0.2 mm ² ... 1.5 mm ²
Conductor cross section flexible	0.2 mm ² ... 2.5 mm ²
	0.25 mm ² ... 2.5 mm ² (Ferrule without plastic sleeve)
	0.25 mm ² ... 2.5 mm ² (Ferrule with plastic sleeve)
Conductor cross section flexible (2 conductors with same cross section)	0.2 mm ² ... 1.5 mm ²
	0.25 mm ² ... 0.75 mm ² (Ferrule without plastic sleeve)
	0.5 mm ² ... 1.5 mm ² (TWIN ferrule with plastic sleeve)
Conductor cross section AWG	24 ... 12
Tightening torque	0.5 Nm ... 0.6 Nm
Pitch	5 mm

Signaling

Status display present	Yes
Operating voltage display	Green LED

Dimensions

Item dimensions

Width	112.3 mm
Height	41 mm
Depth	56.17 mm

Material specifications

Color	gray (RAL 7042)
Flammability rating according to UL 94	V0
Housing insulation material	Polyamide 6.6 green

Environmental and real-life conditions

Ambient conditions

Degree of protection (Module)	IP20
Degree of protection (Installation location)	≥ IP54
Ambient temperature (operation)	-40 °C ... 70 °C
Ambient temperature (storage/transport)	-40 °C ... 70 °C
Altitude	≤ 2000 m

Approvals

PLC-V8L/FLK14/OUT - System connection



2299660

<https://www.phoenixcontact.com/us/products/2299660>

CE

Certificate	CE-compliant
-------------	--------------

UKCA

Certificate	UKCA-compliant
-------------	----------------

UL, USA/Canada

Identification	Class I, Div. 2, Groups A, B, C, D T4
----------------	---------------------------------------

UL, Canada

Identification	Class I, Zone 2, Ex ec IIC Gc T4 X
----------------	------------------------------------

UL, USA

Identification	Class I, Zone 2, AEx ec IIC T4
----------------	--------------------------------

Shipbuilding approval

Certificate	TAE0000196
-------------	------------

DNV GL data

Temperature	D
Humidity	A
Vibration	C
EMC	B
Enclosure	Required protection according to the Rules shall be provided upon installation on board

EMC data

Low Voltage Directive	Conformance with Low Voltage Directive
Electromagnetic compatibility	Conformance with EMC directive

Standards and regulations

Air clearances and creepage distances

Standards/regulations	EN IEC 60664-1
-----------------------	----------------

Mounting

Mounting type	Plug-on assembly
Assembly note	in rows with zero spacing
Mounting position	any

Notes

Notes on operation	For proper use, the specifications of the installation directive (see Downloads) must be observed. For applications or use with third-party products, the specifications, and the safety and warning instructions of the respective third-party manufacturer must also be met.
--------------------	--

PLC-V8L/FLK14/OUT - System connection

2299660

<https://www.phoenixcontact.com/us/products/2299660>

Drawings

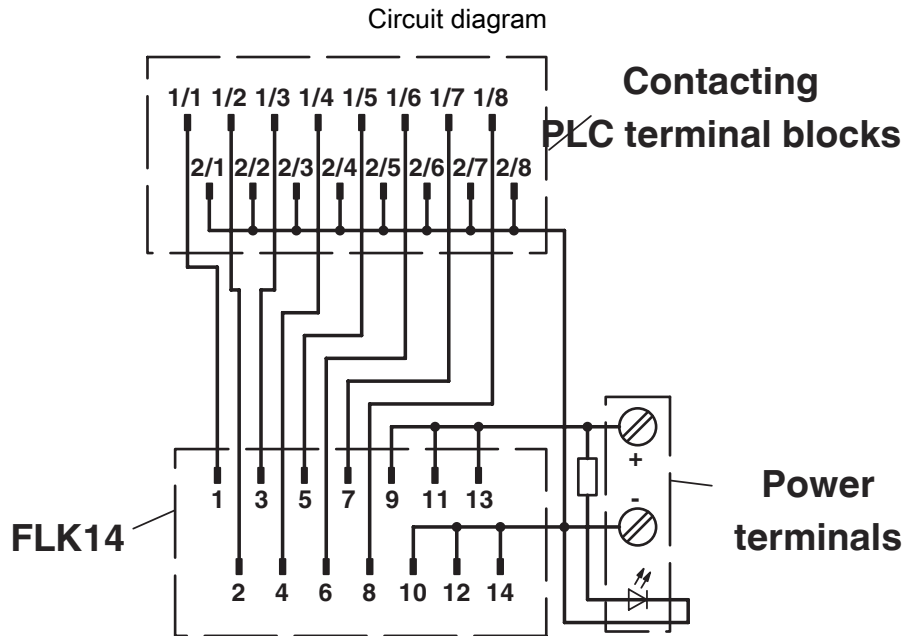

PLC-V8L/FLK14/OUT - System connection



2299660

<https://www.phoenixcontact.com/us/products/2299660>

Dimensional drawing

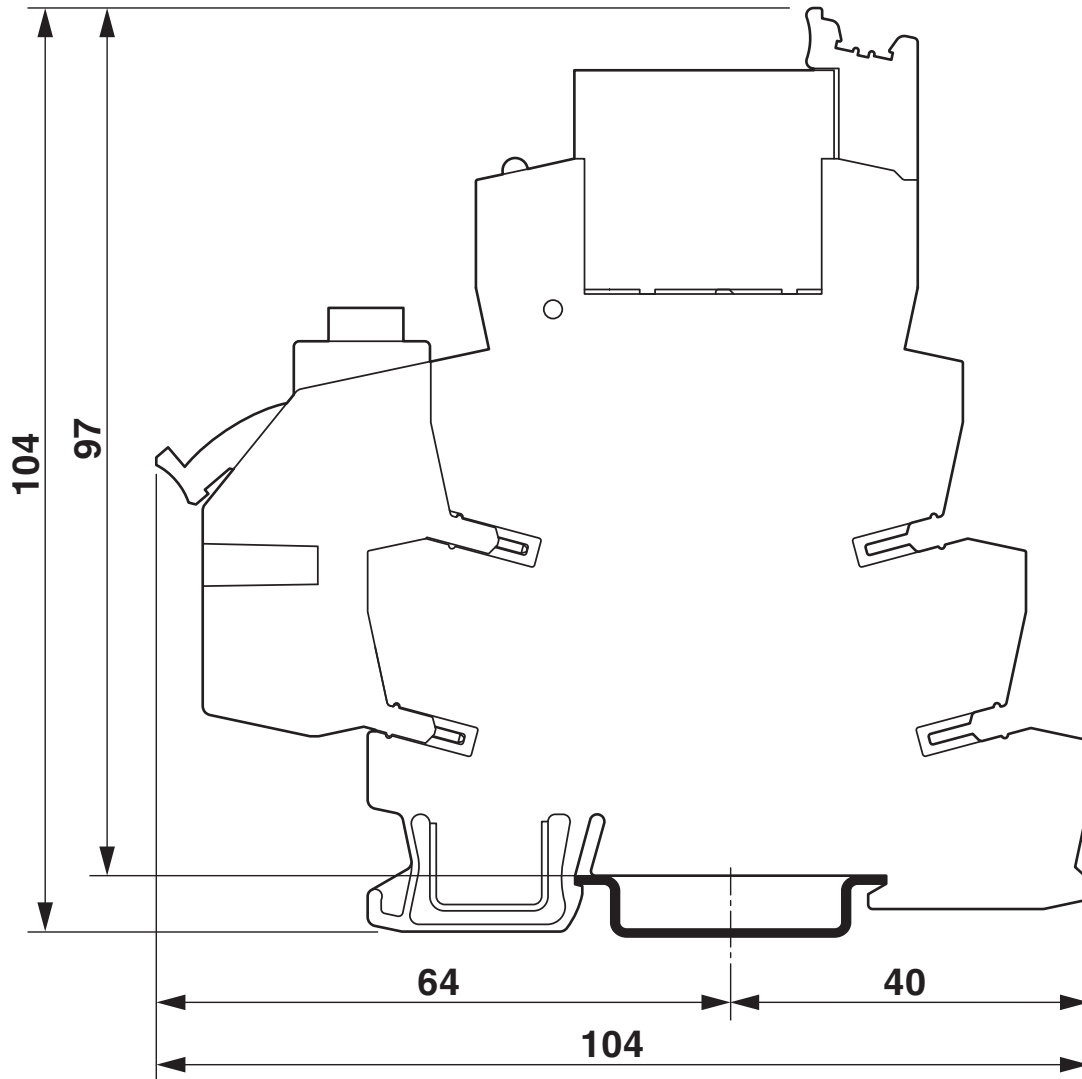

PLC-V8L/FLK14/OUT - System connection





2299660

<https://www.phoenixcontact.com/us/products/2299660>

Approvals

To download certificates, visit the product detail page: <https://www.phoenixcontact.com/us/products/2299660>

 cUL Recognized Approval ID: FILE E 238705	Nominal voltage U_N	Nominal current I_N	Cross section AWG	Cross section mm^2
	24 V	1 A	-	-

 UL Recognized Approval ID: FILE E 238705	Nominal voltage U_N	Nominal current I_N	Cross section AWG	Cross section mm^2
	24 V	1 A	-	-

 DNV GL Approval ID: TAE0000196

 UL Listed Approval ID: FILE E 172140
--

 cUL Listed Approval ID: FILE E 172140

 GL Approval ID: 46016-03 HH

 cUL Listed Approval ID: FILE E 199827

 UL Listed Approval ID: FILE E 199827
--

cULus Recognized

cULus Listed

PLC-V8L/FLK14/OUT - System connection



2299660

<https://www.phoenixcontact.com/us/products/2299660>

cULus Listed

PLC-V8L/FLK14/OUT - System connection



2299660

<https://www.phoenixcontact.com/us/products/2299660>

Classifications

ECLASS

ECLASS-11.0	27141152
ECLASS-13.0	27141152
ECLASS-12.0	27141152

ETIM

ETIM 9.0	EC002780
----------	----------

UNSPSC

UNSPSC 21.0	39121400
-------------	----------

PLC-V8L/FLK14/OUT - System connection



2299660

<https://www.phoenixcontact.com/us/products/2299660>

Environmental product compliance

EU RoHS

Fulfills EU RoHS substance requirements	Yes
Exemption	6(c)

China RoHS

Environment friendly use period (EFUP)	EFUP-50
	An article-related China RoHS declaration table can be found in the download area for the respective article under "Manufacturer declaration". For all articles with EFUP-E, no China RoHS declaration table issued and required.

EU REACH SVHC

REACH candidate substance (CAS No.)	Hexahydromethylphthalic anhydride(CAS: n/a)
	Lead(CAS: 7439-92-1)
SCIP	d7a11033-ba32-4e15-a567-c939ad713689

PLC-V8L/FLK14/OUT - System connection



2299660

<https://www.phoenixcontact.com/us/products/2299660>

Mandatory accessories

PLC-RPT- 24DC/21HC - Relay Module

2900291

<https://www.phoenixcontact.com/us/products/2900291>



PLC-INTERFACE for high continuous currents, consisting of PLC-BPT.../21 HC basic terminal block with Push-in connection and plug-in miniature relay, for mounting on DIN rail NS 35/7,5, limiting continuous current up to 10 A, 1 changeover contact, input voltage 24 V DC

PLC-RSC- 24DC/21HC - Relay Module

2967620

<https://www.phoenixcontact.com/us/products/2967620>



PLC-INTERFACE for high continuous currents, consisting of PLC-BSC.../21 HC basic terminal block with screw connection and plug-in miniature relay, for mounting on NS 35/7,5 DIN rail, limiting continuous current up to 10 A, 1 changeover contact, input voltage 24 V DC

PLC-V8L/FLK14/OUT - System connection



2299660

<https://www.phoenixcontact.com/us/products/2299660>

PLC-RPT- 24DC/21-21 - Relay Module

2900330

<https://www.phoenixcontact.com/us/products/2900330>



PLC-INTERFACE, consisting of PLC-BPT.../21-21 basic terminal block with Push-in connection and plug-in miniature relay with power contact, for mounting on DIN rail NS 35/7,5, 2 changeover contacts, input voltage 24 V DC

PLC-RSC- 24DC/21-21 - Relay Module

2967060

<https://www.phoenixcontact.com/us/products/2967060>



PLC-INTERFACE, consisting of basic terminal block PLC-BSC.../21 with screw connection and plug-in miniature relay with power contact, for assembly on DIN rail NS 35/7,5, 2 changeover contacts, input voltage 24 V DC

PLC-V8L/FLK14/OUT - System connection

2299660

<https://www.phoenixcontact.com/us/products/2299660>

PLC-RPT- 24DC/21-21AU - Relay Module

2900338

<https://www.phoenixcontact.com/us/products/2900338>



PLC-INTERFACE, consisting of PLC-BPT.../21-21 basic terminal block with Push-in connection and plug-in miniature relay with multi-layer gold contact, for mounting on DIN rail NS 35/7,5, 2 changeover contacts, input voltage 24 V DC

PLC-RSC- 24DC/21-21AU - Relay Module

2967125

<https://www.phoenixcontact.com/us/products/2967125>



PLC-INTERFACE, consisting of PLC-BSC.../21 basic terminal block with screw connection and plug-in miniature relay with multi-layer gold contact, for mounting on DIN rail NS 35/7,5, 2 changeover contacts, input voltage 24 V DC

PLC-V8L/FLK14/OUT - System connection

2299660

<https://www.phoenixcontact.com/us/products/2299660>

PLC-RPT- 24DC/ 1IC/ACT - Relay Module

2900298

<https://www.phoenixcontact.com/us/products/2900298>



PLC-INTERFACE for high switch-on currents, consisting of PLC-BPT.../1 IC/ACT basic terminal block with push-in connection and plug-in miniature relay, for mounting on DIN rail NS 35/7,5, max. switch-on current up to 130 A, 1 N/O contact, input voltage 24 V DC

PLC-RSC- 24DC/ 1IC/ACT - Relay Module

2967604

<https://www.phoenixcontact.com/us/products/2967604>



PLC-INTERFACE for high switch-on currents, consisting of PLC-BSC.../1 IC/ACT basic terminal block with screw connection and plug-in miniature relay, for mounting on DIN rail NS 35/7,5, max. switch-on current up to 130 A, 1 N/O contact, input voltage 24 V DC

PLC-V8L/FLK14/OUT - System connection

2299660

<https://www.phoenixcontact.com/us/products/2299660>

PLC-RSC- 24DC/ 1- 1/ACT - Relay Module

2967109

<https://www.phoenixcontact.com/us/products/2967109>



PLC-INTERFACE for output functions, consisting of PLC-BSC.../ACT basic terminal block with screw connection and plug-in miniature relay with power contact, for mounting on DIN rail NS 35/7,5, 2 N/O contacts (1-1), input voltage 24 V DC

PLC-OSC- 24DC/ 24DC/ 5/ACT - Solid-state relay module

2982786

<https://www.phoenixcontact.com/us/products/2982786>



PLC-INTERFACE for output functions, consisting of PLC-BSC.../ACT basic terminal block with screw connection and plug-in miniature solid-state relay, for mounting on DIN rail NS 35/7,5, 1 N/O contact, input: 24 V DC, output: 3 ... 33 V DC/5 A

PLC-V8L/FLK14/OUT - System connection

2299660

<https://www.phoenixcontact.com/us/products/2299660>

PLC-OSC- 24DC/230AC/ 2/ACT - Solid-state relay module

2982760

<https://www.phoenixcontact.com/us/products/2982760>



PLC-INTERFACE for output functions, consisting of PLC-BSC.../ACT basic terminal block with screw connection and plug-in miniature solid-state relay, for mounting on DIN rail NS 35/7,5, 1 N/O contact, input: 24 V DC, output: 24 - 253 V AC/2 A

PLC-RSC- 24DC/21-21/MS - Relay Module

2910502

<https://www.phoenixcontact.com/us/products/2910502>



PLC-INTERFACE, consisting of a relay base and pluggable power contact relay with manual operation, integrated status LED and freewheeling diode, Screw connection, 2 changeover contacts, Freewheeling diode, Input voltage: 24 V DC

PLC-V8L/FLK14/OUT - System connection



2299660

<https://www.phoenixcontact.com/us/products/2299660>

PLC-RSC- 24DC/21-21AU/MS - Relay Module

2910507

<https://www.phoenixcontact.com/us/products/2910507>



PLC-INTERFACE, consisting of a relay base and pluggable multilayer gold contact relay with manual operation, integrated status LED and freewheeling diode, Screw connection, 2 changeover contacts, Freewheeling diode, Input voltage: 24 V DC

PLC-RSC- 24DC/21HC/MS - Relay Module

2910514

<https://www.phoenixcontact.com/us/products/2910514>



PLC-INTERFACE, consisting of a relay base and pluggable power contact relay with manual operation, integrated status LED and freewheeling diode, Screw connection, 1 changeover contact, Polarity protection diode, Freewheeling diode, Input voltage: 24 V DC

PLC-V8L/FLK14/OUT - System connection



2299660

<https://www.phoenixcontact.com/us/products/2299660>

PLC-RPT- 24DC/21-21/MS - Relay Module

2910519

<https://www.phoenixcontact.com/us/products/2910519>



PLC-INTERFACE, consisting of a relay base and pluggable power contact relay with manual operation, integrated status LED and freewheeling diode, Push-in connection, 2 changeover contacts, Freewheeling diode, Input voltage: 24 V DC

PLC-RPT- 24DC/21-21AU/MS - Relay Module

2910524

<https://www.phoenixcontact.com/us/products/2910524>



PLC-INTERFACE, consisting of a relay base and pluggable multilayer gold contact relay with manual operation, integrated status LED and freewheeling diode, Push-in connection, 2 changeover contacts, Freewheeling diode, Input voltage: 24 V DC

PLC-V8L/FLK14/OUT - System connection



2299660

<https://www.phoenixcontact.com/us/products/2299660>

PLC-RPT- 24DC/21HC/MS - Relay Module

2910530

<https://www.phoenixcontact.com/us/products/2910530>



PLC-INTERFACE, consisting of a relay base and pluggable power contact relay with manual operation, integrated status LED and freewheeling diode, Push-in connection, 1 changeover contact, Polarity protection diode, Freewheeling diode, Input voltage: 24 V DC

Accessories

FLK 14/EZ-DR/ 30/KONFEK - Cable

2295729

<https://www.phoenixcontact.com/us/products/2295729>



Round cable set; connection 1: IDC/FLK socket strip (1x 14-position); connection 2: IDC/FLK socket strip (1x 14-position); cable length: 0.3 m

PLC-V8L/FLK14/OUT - System connection



2299660

<https://www.phoenixcontact.com/us/products/2299660>

FLK 14/EZ-DR/ 50/KONFEK - Cable

2288901

<https://www.phoenixcontact.com/us/products/2288901>



Round cable set; connection 1: IDC/FLK socket strip (1x 14-position); connection 2: IDC/FLK socket strip (1x 14-position); cable length: 0.5 m

FLK 14/EZ-DR/ 100/KONFEK - Cable

2288914

<https://www.phoenixcontact.com/us/products/2288914>



Round cable set; connection 1: IDC/FLK socket strip (1x 14-position); connection 2: IDC/FLK socket strip (1x 14-position); cable length: 1 m

PLC-V8L/FLK14/OUT - System connection

2299660

<https://www.phoenixcontact.com/us/products/2299660>

FLK 14/EZ-DR/ 150/KONFEK - Cable

2288927

<https://www.phoenixcontact.com/us/products/2288927>



Round cable set; connection 1: IDC/FLK socket strip (1x 14-position); connection 2: IDC/FLK socket strip (1x 14-position); cable length: 1.5 m

FLK 14/EZ-DR/ 200/KONFEK - Cable

2288930

<https://www.phoenixcontact.com/us/products/2288930>



Round cable set; connection 1: IDC/FLK socket strip (1x 14-position); connection 2: IDC/FLK socket strip (1x 14-position); cable length: 2 m

PLC-V8L/FLK14/OUT - System connection



2299660

<https://www.phoenixcontact.com/us/products/2299660>

FLK 14/EZ-DR/ 250/KONFEK - Cable

2288943

<https://www.phoenixcontact.com/us/products/2288943>



Round cable set; connection 1: IDC/FLK socket strip (1x 14-position); connection 2: IDC/FLK socket strip (1x 14-position); cable length: 2.5 m

FLK 14/EZ-DR/ 300/KONFEK - Cable

2288956

<https://www.phoenixcontact.com/us/products/2288956>



Round cable set; connection 1: IDC/FLK socket strip (1x 14-position); connection 2: IDC/FLK socket strip (1x 14-position); cable length: 3 m

PLC-V8L/FLK14/OUT - System connection



2299660

<https://www.phoenixcontact.com/us/products/2299660>

FLK 14/EZ-DR/ 350/KONFEK - Cable

2288969

<https://www.phoenixcontact.com/us/products/2288969>



Round cable set; connection 1: IDC/FLK socket strip (1x 14-position); connection 2: IDC/FLK socket strip (1x 14-position); cable length: 3.5 m

FLK 14/EZ-DR/ 400/KONFEK - Cable

2288972

<https://www.phoenixcontact.com/us/products/2288972>



Round cable set; connection 1: IDC/FLK socket strip (1x 14-position); connection 2: IDC/FLK socket strip (1x 14-position); cable length: 4 m

PLC-V8L/FLK14/OUT - System connection

2299660

<https://www.phoenixcontact.com/us/products/2299660>

FLK 14/EZ-DR/ 500/KONFEK - Cable

2290834

<https://www.phoenixcontact.com/us/products/2290834>



Round cable set; connection 1: IDC/FLK socket strip (1x 14-position); connection 2: IDC/FLK socket strip (1x 14-position); cable length: 5 m

FLK 14/EZ-DR/ 600/KONFEK - Cable

2290863

<https://www.phoenixcontact.com/us/products/2290863>



Round cable set; connection 1: IDC/FLK socket strip (1x 14-position); connection 2: IDC/FLK socket strip (1x 14-position); cable length: 6 m

PLC-V8L/FLK14/OUT - System connection

2299660

<https://www.phoenixcontact.com/us/products/2299660>

FLK 14/EZ-DR/ 800/KONFEK - Cable

2299563

<https://www.phoenixcontact.com/us/products/2299563>



Round cable set; connection 1: IDC/FLK socket strip (1x 14-position); connection 2: IDC/FLK socket strip (1x 14-position); cable length: 8 m

FLK 14/EZ-DR/1000/KONFEK - Cable

2299576

<https://www.phoenixcontact.com/us/products/2299576>



Round cable set; connection 1: IDC/FLK socket strip (1x 14-position); connection 2: IDC/FLK socket strip (1x 14-position); cable length: 10 m

PLC-V8L/FLK14/OUT - System connection

2299660

<https://www.phoenixcontact.com/us/products/2299660>

FLK 14/EZ-DR/HF/ 50/KONFEK - Cable

2305952

<https://www.phoenixcontact.com/us/products/2305952>



Assembled, halogen-free round cable; connection 1: IDC/FLK socket strip (1x 14-position); connection 2: IDC/FLK socket strip (1x 14-position); cable length: 0.5 m

FLK 14/EZ-DR/HF/ 100/KONFEK - Cable

2305965

<https://www.phoenixcontact.com/us/products/2305965>



Assembled, halogen-free round cable; connection 1: IDC/FLK socket strip (1x 14-position); connection 2: IDC/FLK socket strip (1x 14-position); cable length: 1 m

PLC-V8L/FLK14/OUT - System connection

2299660

<https://www.phoenixcontact.com/us/products/2299660>

FLK 14/EZ-DR/HF/ 150/KONFEK - Cable

2305978

<https://www.phoenixcontact.com/us/products/2305978>



Assembled, halogen-free round cable; connection 1: IDC/FLK socket strip (1x 14-position); connection 2: IDC/FLK socket strip (1x 14-position); cable length: 1.5 m

FLK 14/EZ-DR/HF/ 200/KONFEK - Cable

2305981

<https://www.phoenixcontact.com/us/products/2305981>



Assembled, halogen-free round cable; connection 1: IDC/FLK socket strip (1x 14-position); connection 2: IDC/FLK socket strip (1x 14-position); cable length: 2 m

PLC-V8L/FLK14/OUT - System connection

2299660

<https://www.phoenixcontact.com/us/products/2299660>

FLK 14/EZ-DR/HF/ 250/KONFEK - Cable

2305994

<https://www.phoenixcontact.com/us/products/2305994>



Assembled, halogen-free round cable; connection 1: IDC/FLK socket strip (1x 14-position); connection 2: IDC/FLK socket strip (1x 14-position); cable length: 2.5 m

FLK 14/EZ-DR/HF/ 300/KONFEK - Cable

2304759

<https://www.phoenixcontact.com/us/products/2304759>



Assembled, halogen-free round cable; connection 1: IDC/FLK socket strip (1x 14-position); connection 2: IDC/FLK socket strip (1x 14-position); cable length: 3 m

PLC-V8L/FLK14/OUT - System connection

2299660

<https://www.phoenixcontact.com/us/products/2299660>

FLK 14/EZ-DR/HF/ 400/KONFEK - Cable

2304762

<https://www.phoenixcontact.com/us/products/2304762>



Assembled, halogen-free round cable; connection 1: IDC/FLK socket strip (1x 14-position); connection 2: IDC/FLK socket strip (1x 14-position); cable length: 4 m

FLK 14/EZ-DR/HF/ 500/KONFEK - Cable

2304717

<https://www.phoenixcontact.com/us/products/2304717>



Assembled, halogen-free round cable; connection 1: IDC/FLK socket strip (1x 14-position); connection 2: IDC/FLK socket strip (1x 14-position); cable length: 5 m

PLC-V8L/FLK14/OUT - System connection



2299660

<https://www.phoenixcontact.com/us/products/2299660>

FLK 14/EZ-DR/HF/ 600/KONFEK - Cable

2306003

<https://www.phoenixcontact.com/us/products/2306003>



Assembled, halogen-free round cable; connection 1: IDC/FLK socket strip (1x 14-position); connection 2: IDC/FLK socket strip (1x 14-position); cable length: 6 m

FLK 14-EZ-DR-HF/... - Cable

2314040

<https://www.phoenixcontact.com/us/products/2314040>



Assembled, halogen-free round cable; connection 1: IDC/FLK socket strip (1x 14-position); connection 2: IDC/FLK socket strip (1x 14-position); cable length: variable

PLC-V8L/FLK14/OUT - System connection



2299660

<https://www.phoenixcontact.com/us/products/2299660>

FLK 14/EZ-DR/ 50/KONFEK/S - Cable

2296977

<https://www.phoenixcontact.com/us/products/2296977>



Assembled shielded round cable; connection 1: IDC/FLK socket strip (1x 14-position); connection 2: IDC/FLK socket strip (1x 14-position) (The braided shield is routed to a separate cable end.); cable length: 0.5 m

FLK 14/EZ-DR/ 100/KONFEK/S - Cable

2296980

<https://www.phoenixcontact.com/us/products/2296980>



Assembled shielded round cable; connection 1: IDC/FLK socket strip (1x 14-position); connection 2: IDC/FLK socket strip (1x 14-position) (The braided shield is routed to a separate cable end.); cable length: 1 m

PLC-V8L/FLK14/OUT - System connection



2299660

<https://www.phoenixcontact.com/us/products/2299660>

FLK 14/EZ-DR/ 120/KONFEK/S - Cable

2299071

<https://www.phoenixcontact.com/us/products/2299071>



Assembled shielded round cable; connection 1: IDC/FLK socket strip (1x 14-position); connection 2: IDC/FLK socket strip (1x 14-position) (The braided shield is routed to a separate cable end.); cable length: 1.2 m

FLK 14/EZ-DR/ 150/KONFEK/S - Cable

2296993

<https://www.phoenixcontact.com/us/products/2296993>



Assembled shielded round cable; connection 1: IDC/FLK socket strip (1x 14-position); connection 2: IDC/FLK socket strip (1x 14-position) (The braided shield is routed to a separate cable end.); cable length: 1.5 m

PLC-V8L/FLK14/OUT - System connection



2299660

<https://www.phoenixcontact.com/us/products/2299660>

FLK 14/EZ-DR/ 180/KONFEK/S - Cable

2299084

<https://www.phoenixcontact.com/us/products/2299084>



Assembled shielded round cable; connection 1: IDC/FLK socket strip (1x 14-position); connection 2: IDC/FLK socket strip (1x 14-position) (The braided shield is routed to a separate cable end.); cable length: 1.8 m

FLK 14/EZ-DR/ 200/KONFEK/S - Cable

2297002

<https://www.phoenixcontact.com/us/products/2297002>



Assembled shielded round cable; connection 1: IDC/FLK socket strip (1x 14-position); connection 2: IDC/FLK socket strip (1x 14-position) (The braided shield is routed to a separate cable end.); cable length: 2 m

PLC-V8L/FLK14/OUT - System connection



2299660

<https://www.phoenixcontact.com/us/products/2299660>

FLK 14/EZ-DR/ 300/KONFEK/S - Cable

2299013

<https://www.phoenixcontact.com/us/products/2299013>



Assembled shielded round cable; connection 1: IDC/FLK socket strip (1x 14-position); connection 2: IDC/FLK socket strip (1x 14-position) (The braided shield is routed to a separate cable end.); cable length: 3 m

FLK 14/EZ-DR/ 400/KONFEK/S - Cable

2299026

<https://www.phoenixcontact.com/us/products/2299026>



Assembled shielded round cable; connection 1: IDC/FLK socket strip (1x 14-position); connection 2: IDC/FLK socket strip (1x 14-position) (The braided shield is routed to a separate cable end.); cable length: 4 m

PLC-V8L/FLK14/OUT - System connection



2299660

<https://www.phoenixcontact.com/us/products/2299660>

FLK 14/EZ-DR/ 600/KONFEK/S - Cable

2299039

<https://www.phoenixcontact.com/us/products/2299039>



Assembled shielded round cable; connection 1: IDC/FLK socket strip (1x 14-position); connection 2: IDC/FLK socket strip (1x 14-position) (The braided shield is routed to a separate cable end.); cable length: 6 m

FLK 14/EZ-DR/ 800/KONFEK/S - Cable

2299042

<https://www.phoenixcontact.com/us/products/2299042>



Assembled shielded round cable; connection 1: IDC/FLK socket strip (1x 14-position); connection 2: IDC/FLK socket strip (1x 14-position) (The braided shield is routed to a separate cable end.); cable length: 8 m

PLC-V8L/FLK14/OUT - System connection



2299660

<https://www.phoenixcontact.com/us/products/2299660>

FLK 14/EZ-DR/1000/KONFEK/S - Cable

2299055

<https://www.phoenixcontact.com/us/products/2299055>



Assembled shielded round cable; connection 1: IDC/FLK socket strip (1x 14-position); connection 2: IDC/FLK socket strip (1x 14-position) (The braided shield is routed to a separate cable end.); cable length: 10 m

FLK 50/4X14/EZ-DR/ 50/KONFEK - Cable

2296689

<https://www.phoenixcontact.com/us/products/2296689>



Round cable set; connection 1: IDC/FLK socket strip (1x 50-position); connection 2: IDC/FLK socket strip (4x 14-position); cable length: 0.5 m

PLC-V8L/FLK14/OUT - System connection

2299660

<https://www.phoenixcontact.com/us/products/2299660>

FLK 50/4X14/EZ-DR/ 100/KONFEK - Cable

2296692

<https://www.phoenixcontact.com/us/products/2296692>



Round cable set; connection 1: IDC/FLK socket strip (1x 50-position); connection 2: IDC/FLK socket strip (4x 14-position); cable length: 1 m

FLK 50/4X14/EZ-DR/ 150/KONFEK - Cable

2296702

<https://www.phoenixcontact.com/us/products/2296702>



Round cable set; connection 1: IDC/FLK socket strip (1x 50-position); connection 2: IDC/FLK socket strip (4x 14-position); cable length: 1.5 m

PLC-V8L/FLK14/OUT - System connection

2299660

<https://www.phoenixcontact.com/us/products/2299660>

FLK 50/4X14/EZ-DR/ 200/KONFEK - Cable

2296715

<https://www.phoenixcontact.com/us/products/2296715>



Round cable set; connection 1: IDC/FLK socket strip (1x 50-position); connection 2: IDC/FLK socket strip (4x 14-position); cable length: 2 m

FLK 50/4X14/EZ-DR/ 250/KONFEK - Cable

2305402

<https://www.phoenixcontact.com/us/products/2305402>



Round cable set; connection 1: IDC/FLK socket strip (1x 50-position); connection 2: IDC/FLK socket strip (4x 14-position); cable length: 2.5 m

PLC-V8L/FLK14/OUT - System connection

2299660

<https://www.phoenixcontact.com/us/products/2299660>

FLK 50/4X14/EZ-DR/ 300/KONFEK - Cable

2296728

<https://www.phoenixcontact.com/us/products/2296728>



Round cable set; connection 1: IDC/FLK socket strip (1x 50-position); connection 2: IDC/FLK socket strip (4x 14-position); cable length: 3 m

FLK 50/4X14/EZ-DR/ 400/KONFEK - Cable

2296731

<https://www.phoenixcontact.com/us/products/2296731>



Round cable set; connection 1: IDC/FLK socket strip (1x 50-position); connection 2: IDC/FLK socket strip (4x 14-position); cable length: 4 m

PLC-V8L/FLK14/OUT - System connection

2299660

<https://www.phoenixcontact.com/us/products/2299660>

FLK 50/4X14/EZ-DR/ 600/KONFEK - Cable

2296744

<https://www.phoenixcontact.com/us/products/2296744>



Round cable set; connection 1: IDC/FLK socket strip (1x 50-position); connection 2: IDC/FLK socket strip (4x 14-position); cable length: 6 m

FLK 50/4X14/EZ-DR/1000/KONFEK - Cable

2296773

<https://www.phoenixcontact.com/us/products/2296773>



Round cable set; connection 1: IDC/FLK socket strip (1x 50-position); connection 2: IDC/FLK socket strip (4x 14-position); cable length: 10 m

PLC-V8L/FLK14/OUT - System connection



2299660

<https://www.phoenixcontact.com/us/products/2299660>

FLK 50-4X14-EZ-DR ... - Cable

2302405

<https://www.phoenixcontact.com/us/products/2302405>



Round cable set; connection 1: IDC/FLK socket strip (1x 50-position); connection 2: IDC/FLK socket strip (4x 14-position); cable length: variable

FLK 50-4X14-EZ-DR-S ... - Cable

2302447

<https://www.phoenixcontact.com/us/products/2302447>



Assembled shielded round cable; connection 1: IDC/FLK socket strip (1x 50-position); connection 2: IDC/FLK socket strip (4x 14-position) (The braided shield is routed to four separate cable ends.); cable length: variable

Phoenix Contact 2024 © - all rights reserved
<https://www.phoenixcontact.com>

Phoenix Contact USA
586 Fulling Mill Road
Middletown, PA 17057, United States
(+717) 944-1300
info@phoenixcon.com