



Memory Products

EEPROM • NOR Flash • EERAM • Serial SRAM



Microchip's Memory Products

Memory products are at the heart of electronic devices and systems we use every day. Virtually all consumer electronics, communication, computing, automotive and medical devices require certain types of memory to store software code, data and parametric data. Microchip's broad portfolio of memory products includes:

- Serial EEPROM
- Serial SRAM
- Serial Flash
- Parallel Flash
- Serial EERAM
- NVSRAM
- Parallel EEPROM (including MIL883 product)
- OTP EPROM

Quality Comes First

Microchip has been a leader in non-volatile memory products for over 30 years.

- "Quality Comes First" is at the top of the list of our Guiding Values, which provide the core principles that define our culture and the way we do business.
- As an ISO/TS-16949-certified supplier since 2003, Microchip's aggregate system uniquely supports our commitment to exceptional quality.
- Our EEPROM products are produced in Microchip-owned Fabs as well as Tier-1 foundry partners.
- Our EEPROM products are also tested in house, which enables better planning and inventory management.
- Our "No Obsolescence Policy" allows us to have the industry's longest product lifecycles.

Our lead times are among the shortest in the industry, providing fast and reliable supply to our customers.

Here to Help Throughout Your Product Lifecycle

Reliable Product

- Robust EEPROM technology
 - < 1 PPM fails
 - ~ Zero infant mortality
- SuperFlash® technology memory cell
 - Fastest erases
 - Longest retention
- Specialty memory products

Reliable Support

- Global technical support
- Nearly 200 franchised distributors
- Global training network

Reliable Supply

- Longest product lifecycles
- Over 30 years NVM experience
- Seamless internal and sub-contractor operations

Microchip's Memory Portfolio

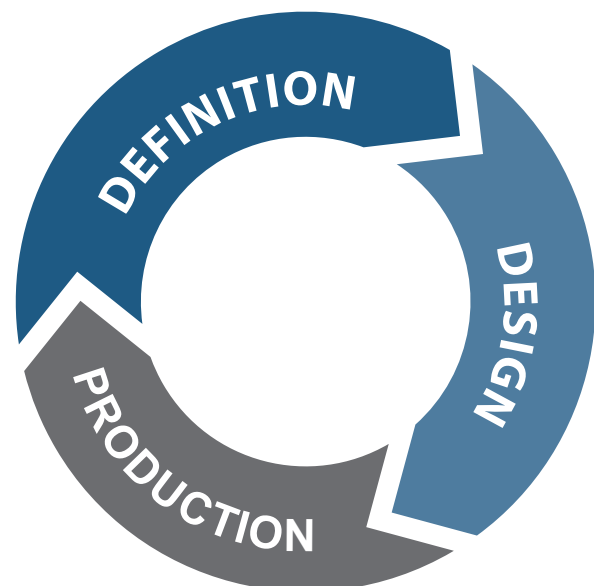
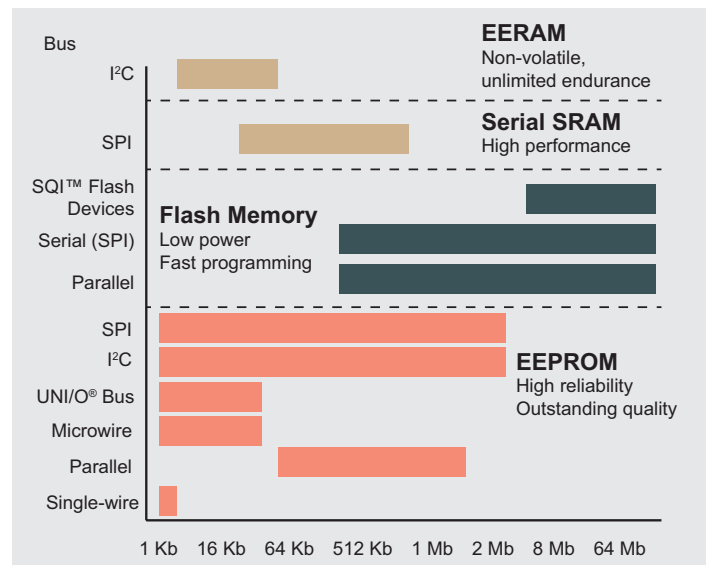

Microchip offers the broadest range of Serial EEPROM devices. Our Serial EEPROMs are low-power, non-volatile memory devices with wide operating ranges, small-size and byte-alterability, making them ideal for data and program storage. Serial EEPROMs can be written more than 1 million times and retain data for over 200 years. Innovative low-power designs and extensive testing have ensured industry-leading endurance and best-in-class quality.

Key Features

- Broad range of densities: 128 bits to 2 Mbit
- Serial architecture: I²C, SPI, UNI/O[®] bus, Single-Wire, Microwire
- Tiny 2-, 3-, 5-, 6- and 8-pin packages; die, wafer and WLCSP
- Innovative and low-power designs
- Industry-leading endurance
- Factory managed MAC address and serial numbering
- Wide temperature and voltage range
 - Operating voltage: 1.7 to 5.5V
 - Temperature range: up to 150°C
- Fast read and write times
- Flexible
 - Byte-write capability
 - Multiple package options
 - Custom programming options
 - Application-specific serial memory
- ISO/TS16949-compliant
- Automotive Grade 0, 1, 2 and 3 with PPAP support

Robust Design

- ESD protection
 - > 4000V Human Body Model (HBM)
 - > 400V Machine Model (MM)
 - > 1000V charged device model
- Latch-up protection > 200 mA on all pins
- ESD-induced latch-up > 100V (MM) on V_{DD}
- > 400V on all I/O
- Up to 150°C operation (read and write)
- Power-On Reset (POR) and Brown-Out Reset (BOR)
 - Effective protection against noisy automotive environments
 - Eliminates false writes
- Schmitt Trigger input filters for noise reductions
- Complete traceability including die location on wafer

Industry-Leading Testing

Microchip's best-in-class field performance is the combined result of world-class manufacturing, wafer-level burn-in and wafer probe quality screens. Microchip's Triple-Test Flow is currently the most robust testing procedure for Serial EEPROM devices in the industry. It tests each cell of each die three times and performs extensive endurance and data retention tests to ensure quality and reliability. Infant mortality of Microchip Serial EEPROMs is among the lowest in the industry due to this extensive testing, excellent fabrication and highly-reliable memory cell design.

Triple-Test Flow

Microchip tests every cell in wafer form twice, then performs a final test after assembly.

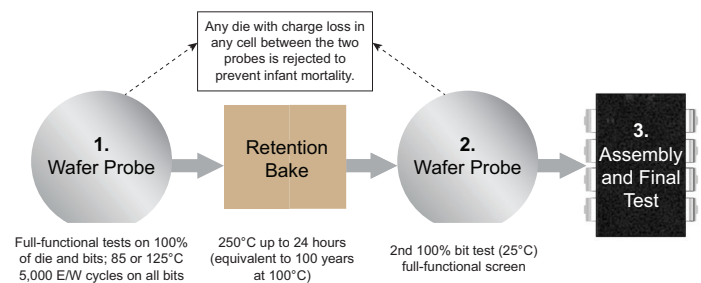

Main Goal: Zero Defects

- Full verification of data sheet parameters for functional compliance at die and package level
- Removal of manufacturing defects to ensure highest quality and reliability
- Screening out of functional devices that may fail in the future

Serial EEPROM Bus Comparison

Parameter	I ² C	Microwire	Single-Wire	UNI/O [®] Bus	SPI
Density Range	128 bits–2 Mbit	1 Kbit–16 Kbit	1 Kbit	1 Kbit–16 Kbit	1 Kbit–2 Mbit
Speed	up to 1 MHz	up to 3 MHz	125 Kbps	up to 100 kHz	up to 20 MHz
I/O Pins	2: Clock, Data	4: Clock, CS, DI, DO	1: Clock/Data	1: Clock/Data	4: SCK, CS, DI, DO
Package Options	PDIP, SOIC, SOIJ, TSSOP, MSOP, 2 × 3 TDFN, 6 × 5 DFN, SOT-23, SC70, WLCSP	PDIP, SOIC, TSSOP, MSOP, 2 × 3 TDFN, SOT-23	SOIC, SOT-23, UDFN, XSFN, WLCSP	PDIP, SOIC, TSSOP, MSOP, 2 × 3 TDFN, SOT-23, TO92, WLCSP	PDIP, SOIC, SOIJ, TSSOP, MSOP, 2 × 3 TDFN, 6 × 5 DFN, SOT-23, WLCSP
Security Options	Hardware/Software	Hardware	Software	Software	Hardware/Software
Pricing	Fewest features/lowest cost ————— Most features/highest cost				

Microchip's best-in-class field performance is the combined result of Wafer Level Burn-In and Wafer Probe-Quality Screens.

Microchip Serial EEPROM Field Return Data

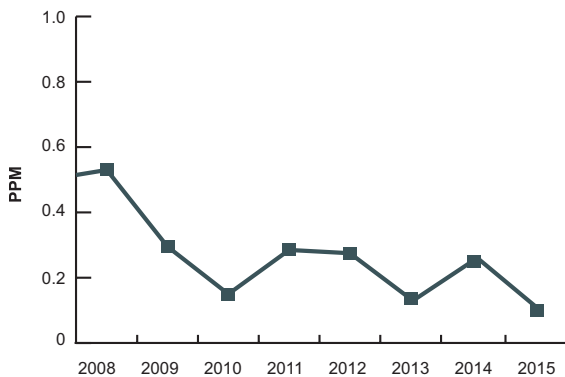

- Industry's lowest field return numbers, best suited for automotive applications
- A decade of improvement

Microchip Serial EEPROM Endurance

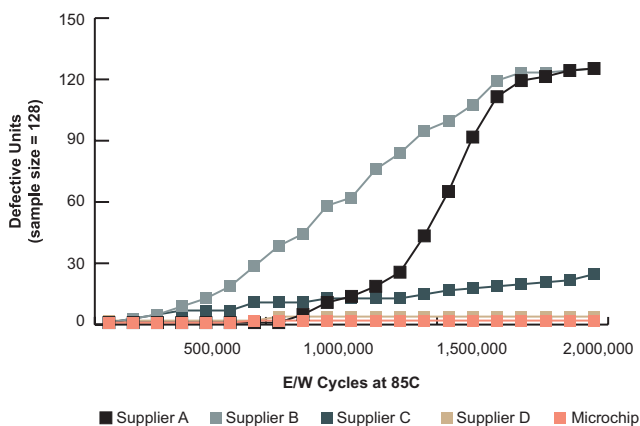

- All devices from supplier A and B failed before 2 million E/W cycles at 85°C
- Testing shows zero Microchip EEPROM failures even at 2 million E/W cycles at 85°C

Standard and Specialty/Application-Specific EEPROMs

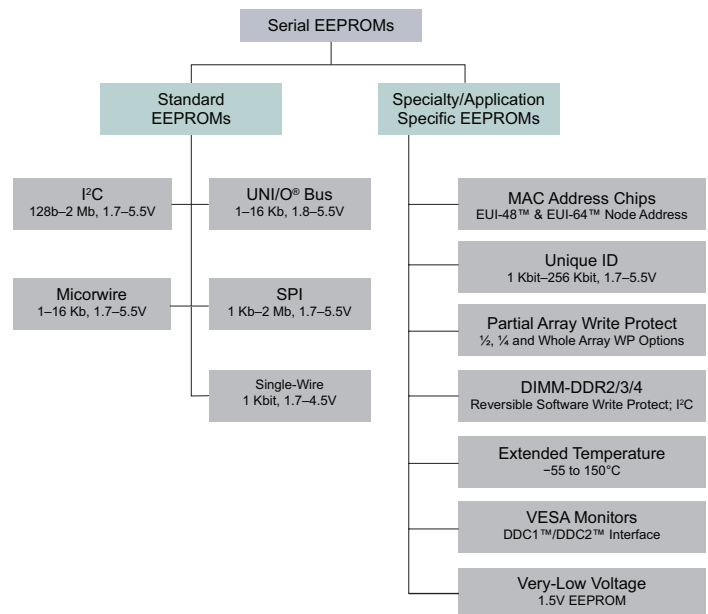

Total Endurance™ Software Model

Total Endurance Software Model provides a comprehensive model that helps estimate the endurance and reliability of Microchip Serial EEPROM devices. By providing operating conditions based on your application, all design trade-offs affecting reliability can be accurately estimated both graphically and numerically in PPM, FIT and MTBF modes, saving time and ensuring a truly robust design. www.microchip.com/totalendurance

EUI-48™/EUI-64™ MAC Address Chips

Need fast, easy and inexpensive access to MAC addresses? Microchip's pre-programmed EUI-48™ MAC address chips have a unique ID and require no serialization.

These plug-and-play Serial EEPROMs provide low cost easy access to IEEE MAC addresses eliminating the need for programming and serialization on the MCU—helping you save cost and get to market faster. For more information visit www.microchip.com/MAC.

I ² C	AT24MAC402/602	1 MHz
SPI	25AA02E48/E64	10 MHz
UNI/O® Bus	11AA02E48/E64	100 kHz
Microwire	93AA46AE48	2 MHz

Plug-and-Play Devices

EUI-48 address embedded in a 2 Kbit Serial EEPROM

- Quick and easy access to IEEE MAC address, read code directly off Serial EEPROM
- Available in SPI, I²C, microwire and UNI/O bus
- At least 1.5 Kbit of Serial EEPROM memory
- Available in SOIC, TSSOP, UDFN and SOT-23 packages
- Write-protected codes
- EUI-48 and EUI-64 compatible
 - EUI-48: networking, Ethernet, Wi-Fi® (IEEE 802.11) and Bluetooth®
 - EUI-64: zigbee® (IEEE 802.15.4), MiWi™ Protocol, FireWire and IPv6
- Can be custom programmed in any memory density

Contact Microchip sales for more information.

Flexibility and Easy to Manage

Quickly add EUI-48 to your networking application and get to market faster.

- Buy code only when needed
- No added programming and serialization costs, reduce system costs
- Code with no volume restrictions
- Unique ID

Write-Protected I²C EEPROMs

Microchip's family of I²C EEPROMs offer whole array or partial array Write-Protection (WP) both Hardware and Software options available. Partial array I²C EEPROM devices are available from 1–64 Kbit.

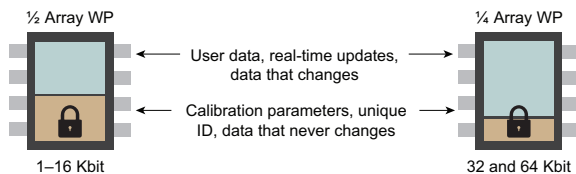

I²C and SPI Serial EEPROMs with Options Ranging From –55°C to 150°C

- Automotive turbo chargers and exhaust gas recirculation
- Automotive fan motors, air valves, flaps and spark plugs
- Aerospace
- Mining (certifications for use in explosive atmospheres available)

Pre-Programmed Serial Number and Unique ID Devices

- Guaranteed unique serial number across family of devices
- Available in I²C, SPI, or UNI/O interface
- Serial Number lengths from 32-bit to 256-bit (see device family)
- Software or Hardware Write-Protection
- Wide array of package options

Unique ID and Serial Number Memory Products

Device	Density (Organization)	Max. Clock Frequency	Operating Voltage (V)	Temperature (°C)	Endurance E/W Cycles	Data Retention	Unique ID Serial Number Features	Write-Protect	Packages
AT24CS01	1 Kbit (x8)	1 MHz	1.7 to 5.5	–40 to +125	1 M	100 years	Preprogrammed 128-bit Serial Number	Whole Array	SOIC, TSOT, TSSOP, UDFN
AT24CS02	2 Kbits (x8)	1 MHz	1.7 to 5.5	–40 to +125	1 M	100 years	Preprogrammed 128-bit Serial Number	Whole Array	SOIC, TSOT, TSSOP, UDFN
24AA02UID	2 Kbits (x8)	400 kHz	1.7 to 5.5	–40 to +85	1 M	200 years	Preprogrammed 32-bit Serial Number Scalable to 48-bit, 64-bit, 128-bit, 256-bit, and other lengths	Half Array	PDIP, SOIC, SOT-23
24AA025UID	2 Kbits (x8)	400 kHz	1.7 to 5.5	–40 to +85	1 M	200 years	Preprogrammed 32-bit Serial Number Scalable to 48-bit, 64-bit, 128-bit, 256-bit, and other lengths	Half Array	PDIP, SOIC, SOT-23
11AA02UID	2 Kbits (x8)	100 kHz	1.8 to 5.5	–40 to +85	1 M	200 years	Preprogrammed 32-bit Serial Number Scalable to 48-bit, 64-bit, 128-bit, 256-bit, and other lengths	W, ¼, ½	SOIC, SOT-23
25AA02UID	2 Kbits (x8)	1 MHz	1.8 to 5.5	–40 to +85	1 M	200 years	Preprogrammed 32-bit Serial Number Scalable to 48-bit, 64-bit, 128-bit, 256-bit, and other lengths	W, ¼, ½	SOIC, SOT-23
AT24CS04	4 Kbits (x8)	1 MHz	1.7 to 5.5	–40 to +125	1 M	100 years	Preprogrammed 128-bit Serial Number	Whole Array	SOIC, TSOT, TSSOP, UDFN
AT24CS08	8 Kbits (x8)	1 MHz	1.7 to 5.5	–40 to +125	1 M	100 years	Preprogrammed 128-bit Serial Number	Whole Array	SOIC, TSOT, TSSOP, UDFN
AT24CS16	16 Kbits (x8)	1 MHz	1.7 to 5.5	–40 to +125	1 M	100 years	Preprogrammed 128-bit Serial Number	Whole Array	SOIC, TSOT, TSSOP, UDFN
AT24CS32	32 Kbits (x8)	1 MHz	1.7 to 5.5	–40 to +125	1 M	100 years	Preprogrammed 128-bit Serial Number	Whole Array	SOIC, TSOT, TSSOP, UDFN
AT24CS64	64 Kbits (x8)	1 MHz	1.7 to 5.5	–40 to +125	1 M	100 years	Preprogrammed 128-bit Serial Number	Whole Array	SOIC, TSSOP, UDFN
AT24CSW01x	1 Kbit (x8)	1 MHz	1.7 to 5.5	–40 to +125	1 M	100 years	Preprogrammed, 128-bit Serial Number with additional 16 bytes user programmable	Five configuration options	WLCSP
AT24CSW02x	2 Kbits (x8)	1 MHz	1.7 to 5.5	–40 to +125	1 M	100 years	Preprogrammed, 128-bit Serial Number with additional 16 bytes user programmable	Five configuration options	WLCSP
AT24CSW04x	4 Kbits (x8)	1 MHz	1.7 to 5.5	–40 to +85	1 M	100 years	Preprogrammed, 128-bit Serial Number with additional 16 bytes user programmable	Five configuration options	WLCSP
AT24CSW08x	8 Kbits (x8)	1 MHz	1.7 to 5.5	–40 to +85	1 M	100 years	Preprogrammed, 128-bit Serial Number with additional 16 bytes user programmable	Five configuration options	WLCSP
24AA256UID	256 Kbits (x8)	400 kHz	1.7 to 5.5	–40 to +85	1 M	200 years	Preprogrammed 32-bit Serial Number Scalable to 48-bit, 64-bit, 128-bit, 256-bit, and other lengths	Permanent Upper ¼	PDIP, SOIC, TSSOP

Serial EEPROM

Device	Density (Organization)	Max. Clock Frequency	Operating Voltage	Temperature (°C)	Endurance E/W Cycles	Data Retention	Write-Protect (Hardware)	Packages
I²C Memory Products								
24XX00	128 bits (x8)	400 kHz	1.7V to 5.5V	-40 to +125	1 M	200 years	—	PDIP, SOIC, SOT-23, TSSOP, 2 x 3 TDFN
24XX01/014	1 Kbit (x8)	400 kHz	1.7V to 5.5V	-40 to +125	1 M	200 years	W, ½	PDIP, SOIC, SOT-23, TSSOP, 2 x 3 TDFN, MSOP, SC70
AT24C01C	1 Kbit (x8)	1 MHz	1.7V to 5.5V	-40 to +125	1 M	100 years	Whole Array	PDIP, SOIC, SOT-23, TSSOP, UDFN, VFBGA
24XX02/024	2 Kbits (x8)	400 kHz	1.7V to 5.5V	-40 to +125	1 M	200 years	W, ½	PDIP, SOIC, SOT-23, TSSOP, 2 x 3 TDFN, MSOP, SC70
AT24C02C	2 Kbits (x8)	1 MHz	1.7V to 5.5V	-40 to +125	1 M	100 years	Whole Array	PDIP, SOIC, SOT-23, TSSOP, UDFN, VFBGA
24XX04	4 Kbits (x8)	400 kHz	1.7V to 5.5V	-40 to +125	1 M	200 years	W, ½	PDIP, SOIC, SOT-23, TSSOP, 2 x 3 TDFN, MSOP, WLCSP
AT24C04C	4 Kbits (x8)	1 MHz	1.7V to 5.5V	-40 to +125	1 M	100 years	Whole Array	PDIP, SOIC, SOT-23, TSSOP, UDFN, VFBGA
24XX08	8 Kbits (x8)	400 kHz	1.7V to 5.5V	-40 to +125	1 M	200 years	W, ½	PDIP, SOIC, SOT-23, TSSOP, 2 x 3 TDFN, MSOP
AT24C08C	8 Kbits (x8)	1 MHz	1.7V to 5.5V	-40 to +125	1 M	100 years	Whole Array	PDIP, SOIC, SOT-23, TSSOP, UDFN, VFBGA
24XX16	16 Kbits (x8)	400 kHz	1.7V to 5.5V	-40 to +125	1 M	200 years	W, ½	PDIP, SOIC, SOT-23, TSSOP, 2 x 3 TDFN, MSOP, WLCSP
AT24C16C	16 Kbits (x8)	1 MHz	1.7V to 5.5V	-40 to +125	1 M	100 years	Whole Array	PDIP, SOIC, SOT-23, TSSOP, UDFN, VFBGA, XDFN
24XX32	32 Kbits (x8)	400 kHz	1.7V to 5.5V	-40 to +125	1 M	200 years	W, ¼	PDIP, SOIC, SOT-23, TSSOP, 2 x 3 TDFN, MSOP, WLCSP
AT24C32D	32 Kbits (x8)	1 MHz	1.7V to 5.5V	-40 to +125	1 M	100 years	Whole Array	SOIC, SOT-23, TSSOP, UDFN, VFBGA, XDFN
24XX64/65	64 Kbits (x8)	1 MHz	1.7V to 5.5V	-40 to +125	1 M/10 M	200 years	W, ¼	PDIP, SOIC, SOT-23, TSSOP, 2 x 3 TDFN, MSOP, WLCSP
AT24C64D	64 Kbits (x8)	1 MHz	1.7V to 5.5V	-40 to +125	1 M	100 years	Whole Array	SOIC, TSSOP, UDFN, XDFN, VFBGA, WLCSP
24XX128	128 Kbits (x8)	1 MHz	1.7V to 5.5V	-40 to +125	1 M	200 years	✓	PDIP, SOIC, TSSOP, 2 x 3 TDFN, 6 x 5 DFN, WLCSP
AT24C128C	128 Kbits (x8)	1 MHz	1.7V to 5.5V	-40 to +125	1 M	100 years	Whole Array	SOIC, TSSOP, UDFN, VFBGA, WLCSP, XDFN
24XX256	256 Kbits (x8)	1 MHz	1.7V to 5.5V	-40 to +125	1 M	200 years	✓	PDIP, SOIC, TSSOP, 6 x 5 DFN, MSOP, WLCSP
AT24C256C	256 Kbits (x8)	1 MHz	1.7V to 5.5V	-40 to +125	1 M	100 years	Whole Array	SOIC, TSSOP, UDFN, VFBGA
24XX512	512 Kbits (x8)	1 MHz	1.7V to 5.5V	-40 to +125	1 M	200 years	✓	PDIP, SOIC, TSSOP, 6 x 5 DFN, WLCSP
AT24C512C	512 Kbits (x8)	1 MHz	1.7V to 3.6V	-40 to +85	1 M	40 years	Whole Array	SOIC, SOI, TSSOP, UDFN, VFBGA, WLCSP
24XX1024	1 Mbit (x8)	1 MHz	1.7V to 5.5V	-40 to +125	1 M	200 years	✓	PDIP, SOIC, SOI, 6 x 5 DFN
AT24CM01	1 Mbit (x8)	1 MHz	1.7V to 5.5V	-40 to +85	1 M	40 years	Whole Array	SOIC, SOI, TSSOP, WLCSP
AT24CM02	2 Mbits (x8)	1 MHz	1.7V to 5.5V	-40 to +125	1 M	100 years	Whole Array	SOIC, WLCSP
UNI/O® Bus/Single-Wire EEPROM Products								
11XX010	1 Kbit (x8)	100 kHz	1.8V to 5.5 V	-40 to +125	1 M	200 years	W, ½, ¼	PDIP, SOIC, SOT-23, TSSOP, 2 x 3 TDFN, MSOP, TO92, WLCSP
AT21CS01	1 Kbit (x8)	125 kbps	1.7V to 3.6V	-40 to +85	1 M	100 years	4x 256-bit zones	SOIC, SOT-23, UDFN, XSFN, WLCSP
AT21CS11	1 Kbit (x8)	125 kbps	2.7V to 4.5V	-40 to +85	1 M	100 years	4x 256-bit zones	SOIC, SOT-23, XSFN, WLCSP
11XX020	2 Kbits (x8)	100 kHz	1.8V to 5.5 V	-40 to +125	1 M	200 years	W, ½, ¼	PDIP, SOIC, SOT-23, TSSOP, 2 x 3 TDFN, MSOP, TO92, WLCSP
11XX040	4 Kbits (x8)	100 kHz	1.8V to 5.5 V	-40 to +125	1 M	200 years	W, ½, ¼	PDIP, SOIC, SOT-23, TSSOP, 2 x 3 TDFN, MSOP, TO92, WLCSP
11XX080	8 Kbits (x8)	100 kHz	1.8V to 5.5 V	-40 to +125	1 M	200 years	W, ½, ¼	PDIP, SOIC, SOT-23, TSSOP, 2 x 3 TDFN, MSOP, TO92, WLCSP
11XX160	16 Kbits (x8)	100 kHz	1.8V to 5.5 V	-40 to +125	1 M	200 years	W, ½, ¼	PDIP, SOIC, SOT-23, TSSOP, 2 x 3 TDFN, MSOP, TO92, WLCSP

Serial EEPROM Products

Device	Density (Organization)	Max. Clock Frequency	Operating Voltage	Temperature (°C)	Endurance E/W Cycles	Data Retention	Write-Protect (Hardware)	Packages
SPI EEPROM Products								
25XX010A	1 Kbit (x8)	10 MHz	1.8V to 5.5V	-40 to +125	1 M	200 years	W, ½, ¼	PDIP, SOIC, SOT-23, TSSOP, 2 x 3 TDFN, MSOP
AT25010B	1 Kbit (x8)	20 MHz	1.7V to 5.5V	-40 to +125	1 M	100 years	W, ½, ¼	SOIC, TSSOP, UDFN, VFBGA
25XX020A	2 Kbits (x8)	10 MHz	1.8V to 5.5V	-40 to +125	1 M	200 years	W, ½, ¼	PDIP, SOIC, SOT-23, TSSOP, 2 x 3 TDFN, MSOP
AT25020B	2 Kbits (x8)	20 MHz	1.7V to 5.5V	-40 to +125	1 M	100 years	W, ½, ¼	SOIC, TSSOP, UDFN
25XX040A	4 Kbits (x8)	10 MHz	1.8V to 5.5V	-40 to +125	1 M	200 years	W, ½, ¼	PDIP, SOIC, SOT-23, TSSOP, 2 x 3 TDFN, MSOP
AT25040B	4 Kbits (x8)	20 MHz	1.7V to 5.5V	-40 to +125	1 M	100 years	W, ½, ¼	SOIC, TSSOP, UDFN, VFBGA
25XX080C / D	8 Kbits (x8)	10 MHz	1.8V to 5.5V	-40 to +125	1 M	200 years	W, ½, ¼	PDIP, SOIC, TSSOP, 2 x 3 TDFN, MSOP
AT25080B	8 Kbits (x8)	5 MHz	1.7V to 5.5V	-40 to +125	1 M	100 years	W, ½, ¼	SOIC, TSSOP, UDFN, VFBGA, WLCSF, XDFN
25XX160C / D	16 Kbits (x8)	10 MHz	1.8V to 5.5V	-40 to +125	1 M	200 years	W, ½, ¼	PDIP, SOIC, TSSOP, 2 x 3 TDFN, MSOP
AT25160B	16 Kbits (x8)	5 MHz	1.7V to 5.5V	-40 to +125	1 M	100 years	W, ½, ¼	SOIC, TSSOP, UDFN, VFBGA, XDFN
25XX320A	32 Kbits (x8)	10 MHz	1.8V to 5.5V	-40 to +125	1 M	200 years	W, ½, ¼	PDIP, SOIC, TSSOP, 2 x 3 TDFN, MSOP
AT25320B	32 Kbits (x8)	5 MHz	1.7V to 5.5V	-40 to +125	1 M	100 years	W, ½, ¼	SOIC, TSSOP, UDFN, VFBGA, XDFN
25XX640A	64 Kbits (x8)	10 MHz	1.8V to 5.5V	-40 to +125	1 M	200 years	W, ½, ¼	PDIP, SOIC, TSSOP, 2 x 3 TDFN, MSOP
AT25640B	64 Kbits (x8)	5 MHz	1.7V to 5.5V	-40 to +125	1 M	100 years	W, ½, ¼	SOIC, TSSOP, UDFN, VFBGA, XDFN
25XX128	128 Kbits (x8)	10 MHz	1.8V to 5.5V	-40 to +125	1 M	200 years	W, ½, ¼	PDIP, SOIC, TSSOP, 6 x 5 DFN
AT25128B	128 Kbits (x8)	20 MHz	1.7V to 5.5V	-40 to +125	1 M	100 years	W, ½, ¼	SOIC, TSSOP, UDFN, VFBGA
25XX256	256 Kbits (x8)	10 MHz	1.8V to 5.5V	-40 to +125	1 M	200 years	W, ½, ¼	PDIP, SOIC, TSSOP, 6 x 5 DFN
AT25256B	256 Kbits (x8)	20 MHz	1.7V to 5.5V	-40 to +125	1 M	100 years	W, ½, ¼	SOIC, SOIJ, TSSOP, UDFN, VFBGA
25XX512	512 Kbits (x8)	20 MHz	1.8V to 5.5V	-40 to +125	1 M	200 years	W, ½, ¼	PDIP, SOIC, 6 x 5 DFN
AT25512	512 Kbits (x8)	20 MHz	1.8V to 5.5V	-40 to +85	1 M	40 years	W, ½, ¼	SOIC, TSSOP, UDFN
25XX1024	1 Mbit (x8)	20 MHz	1.8V to 5.5V	-40 to +125	1 M	200 years	W, ½, ¼	PDIP, SOIJ, 6 x 5 DFN
AT25M01	1 Mbit (x8)	20 MHz	1.7V to 5.5V	-40 to +85	1 M	100 years	W, ½, ¼	SOIC, SOIJ, UDFN, WLCSF
AT25M02	2 Mbits (x8)	5 MHz	1.7V to 5.5V	-40 to +85	1 M	40 years	W, ½, ¼	SOIC, WLCSF
Microwire EEPROM Products								
93XX46A/B/C	1 Kbit (x8 or x16)	3 MHz	1.8V to 5.5V	-40 to +125	1 M	200 years	-	1 mA
AT93C46D	1 Kbit (x8/x16)	2 MHz	1.7V to 5.5V	-40 to +125	1 M	100 years	Software	15.0 µA (Max)
AT93C46E	1 Kbit (x8)	2 MHz	1.8V to 5.5V	-40 to +85	1 M	100 years	Software	15.0 µA (Max)
93XX56A/B/C	2 Kbits (x8 or x16)	3 MHz	1.8V to 5.5V	-40 to +125	1 M	200 years	-	1 mA
AT93C56B	2 Kbits (x8/x16)	2 MHz	1.8V to 5.5V	-40 to +125	1 M	100 years	Software	15.0 µA (Max)
93XX66A/B/C	4 Kbits (x8 or x16)	3 MHz	1.8V to 5.5V	-40 to +125	1 M	200 years	-	1 mA
AT93C66B	4 Kbits (x8/x16)	2 MHz	1.8V to 5.5V	-40 to +125	1 M	100 years	Software	15.0 µA (Max)
93XX76A/B/C	8 Kbits (x8 or x16)	3 MHz	1.8V to 5.5V	-40 to +125	1 M	200 years	Hardware	1 mA
93XX86A/B/C	16 Kbits (x8 or x16)	3 MHz	1.8V to 5.5V	-40 to +125	1 M	200 years	Hardware	1 mA
AT93C86A	16 Kbits (x8/x16)	2 MHz	1.8V to 5.5V	-40 to +125	1 M	100 years	Software	15.0 µA (Max)

Densities: 128-bits to 2 Mbit Serial Architecture: I²C, SPI, UNI/O[®] Bus, Single-Wire, Microwire

More Memory in Less Space!

Serial EEPROM devices from Microchip are available in a wide variety of tiny, innovative packages to help minimize your design, save board space and reduce cost.

- WLCSP: die-sized packages, smallest form factor EEPROM package in the world
- SC-70: among the smallest 5-lead EEPROM package
- 5-pin SOT-23 available up to 64 Kb, 8-pin TDFN up to 1 Mb, 8-pin SOIC up to 2 Mb (I²C)

Density	Max. Speed	SOIC	SOT-23	TSSOP	xDFN	PDIP	MSOP	SOIJ	SC70	TO92	WLCSP
I²C Bus 1.7–5.5V											
128 bit–2 Kbits	400 kHz	✓	5, 6	✓	✓	✓	✓	–	5	–	4
4–32 Kbits	400 kHz	✓	5	✓	✓	✓	✓	✓	–	–	4, 5
64 Kbits	1 MHz	✓	5	✓	✓	✓	✓	✓	–	–	4, 5, 6
128 Kbits	1 MHz	✓	5	✓	✓	✓	✓	✓	–	–	4
256 Kbits	1 MHz	✓	–	✓	✓	✓	✓	✓	–	–	–
512 Kbits	1 MHz	✓	–	8, 14	✓	✓	✓	✓	–	–	8
1 Mbit	1 MHz	✓	–	✓	✓	✓	–	✓	–	–	8
2 Mbits	1 MHz	✓	–	–	–	–	–	–	–	–	8
Microwire Bus 1.8–5.5 V											
1–16 Kbits	3 MHz	✓	6	✓	✓	✓	✓	✓	–	–	–
SPI Bus 1.8–5.5 V											
1–4 Kbits	10 MHz	✓	6	✓	✓	✓	✓	–	–	–	–
8–64 Kbits	10 MHz	✓	–	✓	✓	✓	✓	–	–	–	8
128 Kbits, 256 Kbits	10 MHz	✓	–	✓	✓	✓	–	✓	–	–	–
512 Kbits	20 MHz	✓	–	14	✓	✓	–	✓	–	–	–
1 Mbit	20 MHz	✓	–	✓	✓	✓	–	✓	–	–	8
2 Mbits	5 MHz	✓	–	–	–	–	–	–	–	–	8, 12
UNO[®] Bus 1.8–5.5 V											
1–16 Kbits	100 kHz	✓	3	–	✓	✓	✓	–	–	✓	4
Single-Wire Bus 1.7–4.5 V											
1 Kbit	125 kbps	✓	3	–	2	–	–	–	–	–	4

Number indicates alternate package pin counts available. WLCSP ball array currently available, contact marketing for more information. 8-pad, 1.80 mm x 2.20 mm x 0.40 mm body, 0.40 mm Pitch Extra Thin DFN (XDFN). 8-lead, 2.00 mm x 3.00 mm x 0.55 mm body, 0.50 mm Pitch, Ultra Thin Dual Flat No Lead (UDFN). 8-lead, 2.00 mm x 3.00 mm x 0.75 mm body, 0.50 mm Pitch, TDFN. 8-lead, 2.00 mm x 3.00 mm x 0.90 mm body, 0.50 mm Pitch, DFN.

Available Packages (not to scale)



WLCSP: World's Smallest EEPROM Package

The Wafer-Level Chip Scale Package (WLCSP) from Microchip is a bumped die with a redistribution layer to route the bond pads to the bumps.

- True “die-sized” packages
- Industry’s smallest package form factor
- Lowest profile package
- Available in I²C, SPI, UNI/O bus
- Compatible with standard surface-mount assembly lines
- Fit a large density into a small space

Possible Applications

- Mobile phones
- Security camera
- Sensors
- Smart cables
- Hearing aid
- Medical disposables
- Portable electronics

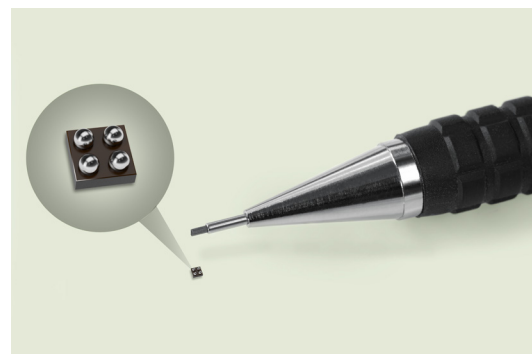

Microchip's Serial SRAM family provides a way to easily and inexpensively add external RAM to almost any application. These serial devices use less power and fewer I/O connections than traditional parallel SRAM, and they allow you to use a smaller microcontroller with additional on-board RAM. Microchip's SPI-compatible Serial SRAM devices are available in 64 Kbits, 256 Kbits, 512 Kbits and 1 Mbit options and up to 20 MHz. The 512 Kbits and 1 Mbit parts support data backup via an external battery/coin cell connected V_{BAT} pin. These 8-pin devices have unlimited endurance and zero write times.

	1.5–1.95V	2.7–3.6V
1 Mbit	23A1024/20 MHz	23LC1024/20 MHz
512 Kbits	23A512/20 MHz	23LC512/20 MHz
256 Kbits	23A256/16 MHz	23K256/20 MHz
64 Kbits	23A640/16 MHz	23K640/20 MHz

Key Features

- SPI Bus, 20 MHz
- Volatile memory
- Operating voltage: 1.5–1.95V and 2.7–3.6V
- Infinite endurance
- Zero write speeds
- Low-power consumption
- Automotive Grade 1 with PPAP support

The Serial SRAM Advantage

Feature	Traditional Parallel SRAM	Microchip's Serial SRAM
I/O Connection to MCU	16–20	4
Standby Current	3 mA	1 µA
Active Current	50 mA	1–10 mA
Lowest Operating Voltage	3.0V	1.7V
Footprint	100 mm ²	20 mm ²
Smallest Packages	28-pin TSSOP, 28-pin SOIC	8-pin TSSOP, 8-pin SOIC

MCU connected to RAM.

MCU connected to Parallel SRAM via 16–20 I/O lines.

MCU connected to Serial SRAM via 4 I/O lines.

Stand-alone Serial SRAM offering greater design flexibility and the opportunity for RAM expansion

Key Benefits

- Lower system costs – innovative products, tiny packages, low-power consumption, fewer I/O pins, small form factor
- Save I/O pins on the MCU – more compact designs, add additional features
- Secure data with write-protect options
- Robust designs with broad operating conditions

Typical Applications

- Metering
- Point-of-Sale (POS) terminals
- Printers
- Internet radio
- Ethernet
- Wi-Fi
- Replace parallel RAM
- Any application needing low-cost RAM

Flexible RAM Expansion

Add features to your current microcontroller and get to market faster.

- Add functionality to your current design
- No need to buy a larger microcontroller just for the RAM
- Familiar 4-pin SPI interface
- Reduce cost in your current design
- Scratchpad, buffering, high-endurance applications

Serial SRAM Products

Device	Density (Organization)	Max. Clock Frequency	Operating Voltage (A, K)	Temperature (I, E) (°C)	Read Current (mA)	Max. Standby Current	Packages	Battery Back-Up
23X640	8 Kbits (64 KB)	20 MHz	1.8V, 3V	–40 to +125	3 mA	4 µA	PDIP, SOIC, TSSOP	No
23X256	32 Kbits (256 KB)	20 MHz	1.8V, 3V	–40 to +125	3 mA	4 µA	PDIP, SOIC, TSSOP	No
23X512	64 Kbits (512 KB)	20 MHz	1.8V, 3V, 5V	–40 to +125	3 mA	4 µA	PDIP, SOIC, TSSOP	Yes
23X1024	125 Kbits (1 MB)	20 MHz	1.8V, 3V, 5V	–40 to +125	3 mA	4 µA	PDIP, SOIC, TSSOP	Yes

1. Voltage Range: A = 1.5–1.95 V, K = 2.7–3.6 V 2. All devices are RoHS-compliant

What is SuperFlash Technology?

Microchip's SuperFlash technology is an innovative, highly reliable and versatile type of NOR Flash memory. SuperFlash technology memory is much more flexible and reliable than competing non-volatile memories. This technology utilizes a split-gate cell architecture which uses a robust thick-oxide process that requires fewer mask steps resulting in a lower-cost nonvolatile memory solution with extremely fast erase time, excellent data retention and higher reliability.

SuperFlash Technology Advantages

- Fast, fixed program and erase times
 - ~ 40 ms for SuperFlash technology vs. more than a minute for conventional 64 Mbits
 - Results in improved manufacturing efficiency and lower costs
- No pre-programming or verification required prior to erase
 - Results in significantly lower power consumption
- Superior reliability
 - 100 K cycles and 100 years data retention
- Inherent small-sector size
 - 4 KB erase sector vs. 64 KB
 - Results in faster re-write operations and contributes to lowering overall power consumption

Serial and Parallel Flash

Serial Flash (25 and 26 Series) are designed for a wide variety of applications in consumer electronics, computing, networking and industrial spaces. Small form factor, standard pinouts and command sets make Serial Flash easy to design in and cost competitive.

Our Parallel Flash (39 and 38 Series) are ideal for GPS/navigation and other mobile devices that require Execute-in-Place (XIP) performance and for demanding industrial and automotive applications.

8 MB Firmware Flash

Microchip is the sole remaining supplier of 8 Mb Firmware Flash. This SuperFlash technology memory device is compliant with the Intel Low Pin Count (LPC) Interface Specification and is intended to store system BIOS in applications such as PCs, point-of-sale systems, set-top boxes, network boards and other embedded CPU applications.

- FWH devices (49LF008A) incorporate Intel's proprietary FWH interface protocol used in the Intel 8XX Series Hub Architecture chipsets.
- LPC Flash devices (49LF080A) comply with the standard Intel Low Pin Count Interface Specification 1.1.

Memory Cell Structure Comparison

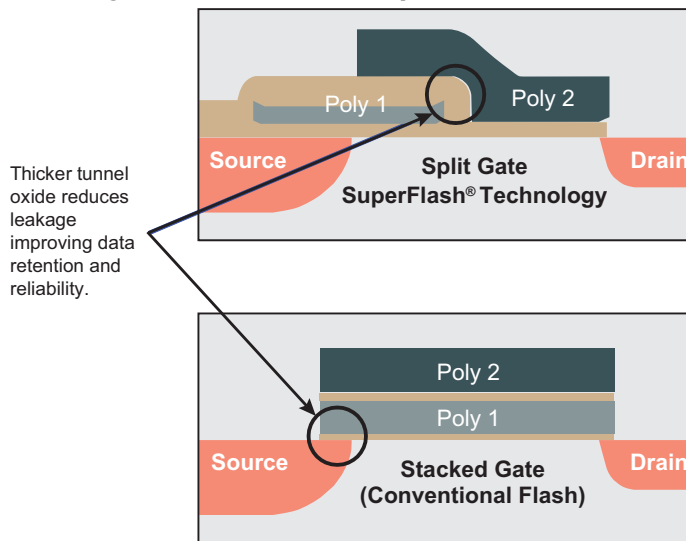

100× Times Faster Erase Times Than Competitors and Chip Erase Time Remains the Same Across All Densities

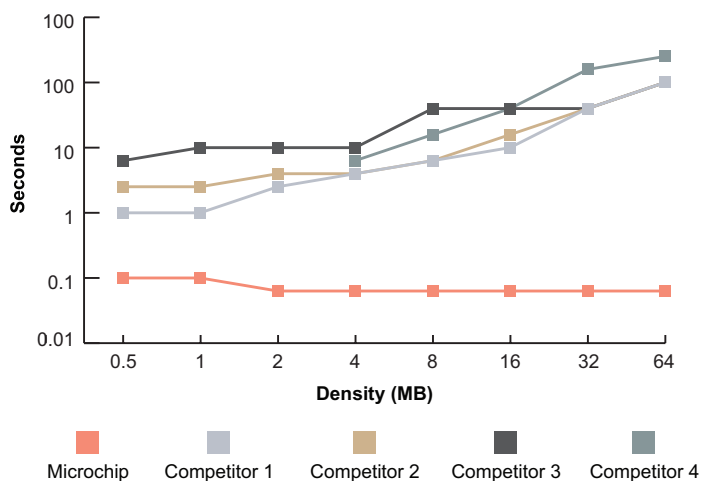

Serial Flash

Serial Flash Key Features

- Serial peripheral interface: Mode 0 and Mode 3
- Small footprint
 - 8-pin SOIC, low-profile 8-contact USON, WSON, 8-bump XFBGA, WLCSP
- Operating voltage
 - 1.65–1.95V, 2.3–3.6V
- Clock frequency up to 104 MHz
- Flexible erase capability
 - 4 Kbyte uniform sector erase
 - 32/64 Kbyte block erase
 - Chip erase
- Endurance: 100,000 cycles (typical)
- Data retention: 100 years (min)
- Fast sector erase or block erase time: 18 ms (typical)
- Byte program time: 7 μ s (typical)
- Active read current: 10 mA (typical)
- Standby current: 5 μ A (typical)
- Proven technology
 - CMOS SuperFlash technology boosts data retention and endurance, and reduces erase time and power consumption, making Microchip Serial Flash ideal for portable designs.

Serial Flash Applications

- Home networking
- HDTVs
- Bluetooth
- Wearable devices
- Tablets
- Notebook
- Printers
- Wireless LAN
- Set-top boxes
- Digital radios
- Automotive
- Servers
- IoT devices
- Smart appliances
- Smart meters

Serial SPI Flash

25 Series

Serial SPI Flash is a small, low-power Flash memory that features a Serial Peripheral Interface (SPI) and pin-for-pin compatibility with industry-standard SPI EEPROM devices. Its small footprint reduces ASIC controller pin count and packaging costs, saves board space and keeps system costs down. Offering lower power consumption and fewer wires than Parallel Flash, Serial SPI Flash is the ideal cost-efficient data transfer solution. Serial SPI Flash-Specific Features

- Densities up to 16 MB
- Full SPI protocol compatibility

Serial Quad I/O™ (SQI™) Flash

26 Series

SQI Flash memory uses 4-bit multiplexed I/O serial protocol, boosts performance while maintaining the compact form factor of standard SPI Flash. SQI devices can be used in Quad, Dual or SPI mode so it is backward compatible with SPI devices.

SQI Flash-Specific Features

- 4-bit multiplexed I/O serial protocol
- > 300 Mbps sustained read
- Density: 4 Mb to 64 Mb
- Software parameter and overlay block locking
- Security ID
- Page mode programming
- Serial Flash Discoverable Parameters (SFDP)
- Automotive Grade 2 and 3 with PPAP support

Flash Performance Comparison

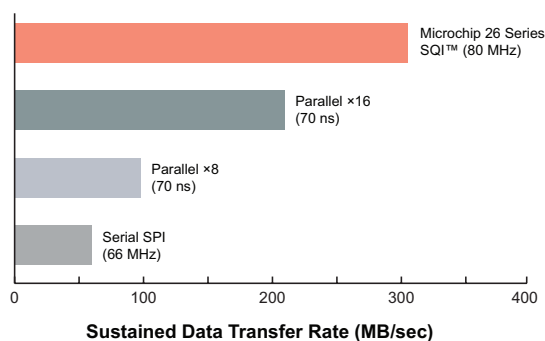

Serial Flash

Small Footprint Serial Peripheral Interface Flash

Bus	Product	Density	Organization	Max. Clock Frequency	Operating Voltage (V)	Temperature Range (°C)	E/W Endurance (Minimum)	Data Retention (Minimum) (Years)	Write Speed (Typical)	Max. Standby Current	Special/Unique Features	Packages*
x1	SST25VF512A	512 Kb	64K × 8	33 MHz	2.7–3.6	0 to +70 –40 to +85 –20 to +85	100,000 cycles (typical)	100	14 µs (Byte Program)	8 µA	Auto address increment programming, Fast read, program and erase	8L-SOIC, 8C-WSON
	SST25VF010A	1 Mb	128K × 8	33 MHz	2.7–3.6	0 to +70 –40 to +85 –20 to +85	100,000 cycles (typical)	100	14 µs (Byte Program)	8 µA	Auto address increment programming, Fast read, program and erase	8L-SOIC, 8C-WSON
	SST25VF020B	2 Mb	256K × 8	80 MHz	2.7–3.6	0 to +70 –40 to +85	100,000 cycles (typical)	100	7 µs (Word Program)	5 µA	Auto address increment programming, Fast read, program and erase	8L-SOIC, 8C-WSON
	SST25WF020A	2 Mb	256K × 8	40 MHz	1.65–1.95	0 to +70 –40 to +85	100,000 cycles (typical)	20	3 ms (Page Program)	10 µA	Single-input page program, Fast read, program and erase	8L-SOIC, 8C-WSON, 8C-USON, 9B-WLCS
	SST25PF040C	4 Mb	512K × 8	40 MHz	2.3–3.6	–40 to +85	100,000 cycles (minimum)	20	4 ms/256 bytes (typical)	50 µA	Software Write Protection- Write protection through Block-Protection bits	8C-USON, 8L-SOIC, 8C-WDFN
	SST25VF040B	4 Mb	512K × 8	40 MHz	2.7–3.6	–40 to +85	100,000 cycles (typical)	100	7 µs (Word Program)	5 µA	Auto address increment programming, Fast read, program and erase	8L-SOIC, 8C-WSON
	SST25VF080B	8 Mb	1M × 8	40 MHz	2.7–3.6	–40 to +85	100,000 cycles (typical)	100	7 µs (Word Program)	5 µA	Auto address increment programming, Fast read, program and erase	8L-SOIC, 8C-WSON, 8B-XFBGA
	SST25VF016B	16 Mb	2M × 8	50 MHz	2.7–3.6	–40 to +85	100,000 cycles (typical)	100	7 µs (Word Program)	5 µA	Auto address increment programming, Fast read, program and erase	8L-SOIC, 8C-WSON
x1, x2	SST25WF040B	4 Mb	512K × 8	40 MHz	1.65–1.95	0 to +70 –40 to +85	100,000 cycles (typical)	20	1 ms (Page Program)	10 µA	Dual output and dual I/O read, Single- and dual-input page program, Fast read, program and erase	8L-SOIC, 8C-USON, 9B-WLCS
	SST25WF080B	8 Mb	1M × 8	40 MHz	1.65–1.95	0 to +70 –40 to +85	100,000 cycles (typical)	20	1 ms (Page Program)	10 µA	Dual output and dual I/O read, Single- and dual-input page program, Fast read, program and erase	8L-SOIC, 8C-USON, 9B-WLCS
x4	SST26VF016	16 Mb	2M × 8	80 MHz	2.7–3.6	–40 to +85	100,000 cycles (minimum)	100	1 ms (Page Program)	15 µA	Serial Quad I/O™ (SQI™) read/program/erase, Burst read, Index jump feature, Individual block read and write protection. Fast read, program and erase	8L-SOIJ, 8C-WSON
	SST26VF032	32 Mb	4M × 8	80 MHz	2.7–3.6	–40 to +85	100,000 cycles (minimum)	100	1 ms (Page Program)	15 µA	Serial Quad I/O (SQI) read/program/erase, Burst read, Index jump feature, Individual block read and write protection. Fast read, program and erase	8L-SOIJ, 8C-WSON
	SST26WF040B	4 Mb	512K × 8	104 MHz	1.65–1.95	–40 to +85	100,000 cycles (minimum)	100	1.5 ms page (typical)	40 µA	×1, ×2, ×4 Serial Peripheral Interface (SPI) Protocol -Burst Modes, Software Write Protection: Individual Block-Locking: 64 KByte blocks, two 32 KByte blocks, and eight 8 KByte parameter blocks	8C-USON, 8L-SOIC, 8C-WDFN, 8B-XFBGA
x1, x2, x4	SST26WF080B/BA	8 Mb	1M × 8	104 MHz	1.65–1.95	–40 to +85	100,000 cycles (minimum)	100	1 ms (Page Program)	40 µA	×1, ×2, ×4 read, Single- and quad-input page program, Burst read, Write suspend, Individual block read and write protection, Fast read, program and erase	8L-SOIC, 8C-WSON, 8C-USON, 8B-WLCS
	SST26WF016B/BA	16 Mb	2M × 8	104 MHz	1.65–1.95	–40 to +85	100,000 cycles (minimum)	100	1 ms (Page Program)	40 µA	×1, ×2, ×4 read, Single- and quad-input page program, Burst read, Write suspend, Individual block read and write protection, Fast read, program and erase	8L-SOIC, 8C-WSON, 8B-WLCS
	SST26WF064C	64 Mb	8M × 8	104 MHz	1.65–1.95	–40 to +85	100,000 cycles (minimum)	100	1.5 ms (Page Program)	40 µA	×1, ×2, ×4, DTR read, Single- and quad-input page program, Burst read, Write suspend, Individual block read and write protection, Fast read, program and erase	8L-SOIJ, 16L-SOIC, 8C-WSON, 24B-TBGA
	SST26VF016B	16 Mb	2M × 8	104 MHz	2.3–3.6	–40 to +105	100,000 cycles (minimum)	100	1 ms (Page Program)	45 µA	×1, ×2, ×4 read, Single- and quad-input page program, Burst read, Write suspend, Individual block read and write protection, Fast read, program and erase	8L-SOIC, 8L-SOIJ, 8C-WSON
	SST26VF032B/BA	32 Mb	4M × 8	104 MHz	2.3–3.6	–40 to +105	100,000 cycles (minimum)	100	1 ms (Page Program)	45 µA	×1, ×2, ×4 read, Single- and quad-input page program, Burst read, Write suspend, Individual block read and write protection, Fast read, program and erase	8L-SOIJ, 8C-WSON, 24B-TBGA
	SST26VF064B/BA	64 Mb	8M × 8	104 MHz	2.3–3.6	–40 to +105	100,000 cycles (minimum)	100	1 ms (Page Program)	45 µA	×1, ×2, ×4 read, Single- and quad-input page program, Burst read, Write suspend, Individual block read and write protection, Fast read, program and erase	8L-SOIJ, 16L-SOIC, 8C-WSON, 8C-TDFN-S, 24B-TBGA

*Data varies for different devices, please refer to the datasheet for details.

Parallel Flash

Multi-Purpose Flash Devices (MPF™ Devices) Multi-Purpose Flash Plus Devices (MPF+ Devices) 39 Series

Multi-Purpose Flash and Multi-Purpose Flash Plus make up a family of Parallel Flash memory products that deliver high performance, low-power consumption, superior reliability and small sector size. Based on Microchip's SuperFlash technology, MPF and MPF+ provide faster program, erase and read times than conventional Flash, thereby saving power consumption and increasing manufacturing throughput.

In addition to offering 3V and 5V memory products, MPF devices and MPF+ devices provide 1.8V that deliver significant power savings compared to industry standard Flash. Ideal for space-constrained applications, this family offers the industry's smallest standard packages, the XFLGA and WFBGA, both as small as 4 × 6 mm.

Advanced Multi-Purpose Flash Plus Devices (Advanced MPF+ Devices) 38 Series

Advanced MPF+ memory devices incorporate advanced security and protection features, page read access and better write programming into the standard MPF+ family. Currently these devices are available on 64 Mb only.

Parallel Flash Applications

- Bluetooth
- GPS
- Wi-Fi/WiMAX
- Mobile phones
- DSL/cable modems
- Servers and routers
- Set-top boxes
- Digital cameras
- Industrial
- Automotive infotainment

Parallel Flash Key Features

- Densities from 512 Kb through 64 Mb
- Hardware reset/boot block/erase suspend
- Security ID and page read/write on 64 Mb
- Operating voltages:
 - 1.65–1.95V, 2.7–3.6V, 4.5–5.5V
- Low-power consumption
 - Active current: 5 mA (typical)
 - Standby current: 3 µA (typical)
- Fast read access times
 - 55 ns and 70 ns (39 series), 25 ns (38 series)
- Fast programming*
 - 7 µs per word (typical, 39 series)
 - 1.75 µs per word (typical, 38 series)
- Flexible erase capability and fast erase times*
 - 2 Kword sector erase: 18 ms (typical)
 - 32 Kword block erase: 18 ms (typical)
 - Chip erase: 70 ms (typical)
- Small uniform sector sizes: 2 Kword and 32 Kword
- Commercial and industrial operating temperatures
- Endurance: 100,000 cycles (typical)
- Data retention: 100 years (min)
- MPF+ devices offer additional features
 - Erase suspend
 - Boot block
 - Hardware reset features
- Advanced protection features (38 series)

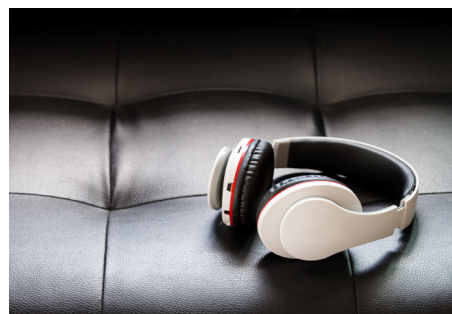

Parallel Flash

High Performance, Low-Power

Bus	Product*	Density	Organization	Access Time	Operating Voltage	Temperature Range (°C)	E/W Endurance (Minimum)	Data Retention (Minimum) (years)	Write Speed (Typical)	Typ. Standby Current	Write Protect Hardware	Write Protect Software	Protected Array Size	Special/Unique Features	Packages**
Parallel Flash Memory															
x8	SST39SF010A	1 Mb	128K × 8	70 ns	4.5–5.5V	0 to +70 –40 to +85	100,000 cycles	100	14 µs (Byte Program)	30 µA	–	–	N/A	Fast read, program and erase; Low power; Small erase sector	32L-PLCC, 32L-PDIP, 32L-TSOP
	SST39LF010	1 Mb	512K × 8	55 ns	3.0–3.6V	0 to +70	100,000 cycles	100	14 µs (Byte Program)	1 µA	–	–	N/A	Fast read, program and erase; Low power; Small erase sector	48B-TFBGA, 32L-TSOP, 32L-PLCC
	SST39VF010	1 Mb	512K × 8	70 ns	2.7–3.6V	0 to +70 –40 to +85	100,000 cycles	100	14 µs (Byte Program)	1 µA	–	–	N/A	Fast read, program and erase; Low power; Small erase sector	48B-TFBGA, 32L-TSOP, 32L-PLCC
	SST39LF020	2 Mb	512K × 8	55 ns	3.0–3.6V	0 to +70	100,000 cycles	100	14 µs (Byte Program)	1 µA	–	–	N/A	Fast read, program and erase; Low power; Small erase sector	48B-TFBGA, 32L-TSOP, 32L-PLCC
	SST39SF020A	2 Mb	256K × 8	55/70 ns	4.5–5.5V	0 to +70 –40 to +85	100,000 cycles	100	14 µs (Byte Program)	30 µA	–	–	N/A	Fast read, program and erase; Low power; Small erase sector	32L-PLCC, 32L-PDIP, 32L-TSOP
	SST39VF020	2 Mb	512K × 8	70 ns	2.7–3.6V	0 to +70 –40 to +85	100,000 cycles	100	14 µs (Byte Program)	1 µA	–	–	N/A	Fast read, program and erase; Low power; Small erase sector	48B-TFBGA, 32L-TSOP, 32L-PLCC
	SST39SF040	4 Mb	512K × 8	70 ns	4.5–5.5V	0 to +70 –40 to +85	100,000 cycles	100	14 µs (Byte Program)	30 µA	–	–	N/A	Fast read, program and erase; Low power; Small erase sector	32L-PLCC, 32L-PDIP, 32L-TSOP
	SST39LF040	4 Mb	512K × 8	55 ns	3.0–3.6V	0 to +70	100,000 cycles	100	14 µs (Byte Program)	1 µA	–	–	N/A	Fast read, program and erase; Low power; Small erase sector	48B-TFBGA, 32L-TSOP, 32L-PLCC
	SST39VF040	4 Mb	512K × 8	70 ns	2.7–3.6V	0 to +70 –40 to +85	100,000 cycles	100	14 µs (Byte Program)	1 µA	–	–	N/A	Fast read, program and erase; Low power; Small erase sector	48B-TFBGA, 32L-TSOP, 32L-PLCC
	SST39VF168X	16 Mb	2M × 8	70 ns	2.7–3.6V	0 to +70 –40 to +85	100,000 cycles	100	7 µs (Byte Program)	3 µA	Y	–	64 KB	Fast read, program and erase; Low power; Small erase sector	48B-TFBGA, 48L-TSOP
x16	SST39LF200A	2 Mb	128K × 16	55 ns	3.0–3.6V	0 to +70	100,000 cycles (typical)	100	14 µs (Word Program)	3 µA	–	–	N/A	Fast read, program and erase; Low power; Small erase sector	48B-TFBGA, 48L-TSOP
	SST39VF200A	2 Mb	128K × 16	70 ns	2.7–3.6V	0 to +70 –40 to +85	100,000 cycles (typical)	100	14 µs (Word Program)	3 µA	–	–	N/A	Fast read, program and erase; Low power; Small erase sector	48B-TFBGA, 48L-TSOP, 48B-WFBGA
	SST39LF40XC	4 Mb	256K × 16	55 ns	3.0–3.6V	0 to +70	100,000 cycles	100	7 µs (Word Program)	3 µA	Y	–	8 KB	Fast read, program and erase; Low power; Small erase sector; Industry standard command set and boot block structure	48B-TFBGA, 48L-TSOP, 48B-WFBGA
	SST39WF400B	4 Mb	256K × 16	70 ns	1.65–1.95V	0 to +70 –40 to +85	100,000 cycles (typical)	100	28 µs (Word Program)	40 µA	–	–	N/A	Fast read, program and erase; Low power; Small erase sector	48B-TFBGA, 48B-WFBGA, 48B-XFBGA
	SST39VF40XC	4 Mb	256K × 16	70 ns	2.7–3.6V	0 to +70 –40 to +85	100,000 cycles	100	7 µs (Word Program)	3 µA	Y	–	8 KB	Fast read, program and erase; Low power; Small erase sector; Industry standard command set and boot block structure	48B-TFBGA, 48L-TSOP, 48B-WFBGA
	SST39WF800B	8 Mb	512K × 16	70 ns	1.65–1.95V	0 to +70 –40 to +85	100,000 cycles (typical)	100	28 µs (Word Program)	40 µA	–	–	N/A	Fast read, program and erase; Low power; Small erase sector	48B-TFBGA, 48B-WFBGA, 48B-XFBGA
	SST39LF80XC	8 Mb	512K × 16	55 ns	3.0–3.6V	0 to +70	100,000 cycles	100	7 µs (Word Program)	3 µA	Y	–	N/A	Fast read, program and erase; Low power; Small erase sector; Industry standard command set and boot block structure	48B-TFBGA, 48L-TSOP, 48B-WFBGA
	SST39VF80XC	8 Mb	512K × 16	70 ns	2.7–3.6V	0 to +70 –40 to +85	100,000 cycles	100	7 µs (Word Program)	3 µA	Y	–	N/A	Fast read, program and erase; Low power; Small erase sector; Industry standard command set and boot block structure	48B-TFBGA, 48L-TSOP, 48B-WFBGA
	SST39WF160X	16 Mb	1M × 16	70 ns	1.65–1.95V	0 to +70 –40 to +85	100,000 cycles (typical)	100	28 µs (Word Program)	40 µA	Y	–	64 KB	Fast read, program and erase; Low power; Small erase sector	48B-TFBGA, 48B-WFBGA, 48B-XFBGA
	SST39VF160XC	16 Mb	1M × 16	70 ns	2.7–3.6V	0 to +70 –40 to +85	100,000 cycles	100	7 µs (Word Program)	3 µA	Y	–	8 KB	Fast read, program and erase; Low power; Small erase sector; Industry standard command set and boot block structure	48B-TFBGA, 48L-TSOP, 48B-WFBGA
	SST39VF160X	16 Mb	2M × 8	70 ns	2.7–3.6V	0 to +70 –40 to +85	100,000 cycles	100	7 µs (Byte Program)	3 µA	Y	–	64 KB	Fast read, program and erase; Low power; Small erase sector	48B-TFBGA, 48L-TSOP
	SST39VF320XB	32 Mb	2M × 16	70 ns	2.7–3.6V	0 to +70 –40 to +85	100,000 cycles	100	7 µs (Word Program)	4 µA	Y	–	32 KB	Fast read, program and erase; Low power; Small erase sector	48B-TFBGA, 48L-TSOP
	SST39VF320XC	32 Mb	2M × 16	70 ns	2.7–3.6V	0 to +70 –40 to +85	100,000 cycles	100	7 µs (Word Program)	4 µA	Y	–	8 KB	Fast read, program and erase; Low power; Small erase sector; Industry standard command set and boot block structure	48B-TFBGA, 48L-TSOP
	SST38VF640X	64 Mb	4M × 16	70 ns	2.7–3.6V	0 to +70 –40 to +85	100,000 cycles	100	7 µs/1.75 µs (Write Buffer Program)	3 µA	Y	Y	32 KB/8 KB	Fast read, program and erase; Low power; Small erase sector; Industry standard command set and boot block structure, Security features	48B-TFBGA, 48L-TSOP
	SST38VF640XB	64 Mb	4M × 16	70 ns	2.7–3.6V	0 to +70 –40 to +85	100,000 cycles	100	7 µs/1.75 µs (Write Buffer Program)	3 µA	Y	Y	32 KB/8 KB	Fast read, program and erase; Low power; Industry standard command set and boot block structure, Security features	48B-TFBGA, 48L-TSOP

Faster Real Time

Microchip is the world's leading manufacturer of parallel EEPROM devices. Parallel EEPROMs enable stored data to be updated byte-by-byte or by full sector, providing design flexibility. The parallel interface devices offer faster read times than serial Interface protocols. Microchip provides a complete selection of densities (64 Kbit to 1 Mbit), operating voltages and device packages. Microchip's Battery Voltage™ (2.7V), low voltage (3V) and 5V devices are used extensively across a broad spectrum of products, including telecommunications, avionics and military applications.

Key Features

- Parallel
- Non-volatile memory
- Operating voltage: 2.7–3.6V, 3.0–3.6V, 4.5–5.5V
- Fast write options
- Industrial and Mil temperature (–55 to 125°C) options
- Ceramic hermetic packages
- Dual marking of specified military drawings and Microchip part numbers

Typical Applications

- Telecommunications
- Avionics
- Aircraft engine controllers
- Mission critical 2-way radio communications
- Military systems

Key Benefits

- Hardware and software data protection
- Built in error correction circuits
- High reliability



MIL Product

Root/SMD Part Number	Density	Organization	V _{CC} (V)	Endurance (10 yr Data Retention)	Access Speed (ns)	CERAMIC Package		
AT28C256 5962-88525 03/06 11/14	256 Kbits	32 Kbits x 8	4.5–5.5V	10k Write Cycles	150, 200, 250	CERDIP (28D)	CLCC (32L)	FLATPACK (28F)
AT28C256E 5962-88525 05/08 13/16				100k Write Cycles	150, 200, 250	CERDIP (28D)	CLCC (32L)	FLATPACK (28F)
AT28C256F 5962-88525 07/15				10k Write Cycles	150 (3 ms Fast Write Option)	CERDIP (28D)	CLCC (32L)	FLATPACK (28F)
AT28HC256 5962-88634 01/03				10k Write Cycles	90, 120	CERDIP (28D)	CLCC (32L)	FLATPACK (28F)
AT28HC256E				100k Write Cycles	90, 120	CERDIP (28D)	CLCC (32L)	FLATPACK (28F)
AT28HC256F 5962-88634 02/04				10k Write Cycles	90, 120 (3 ms Fast Write Option)	CERDIP (28D)	CLCC (32L)	FLATPACK (28F)
AT28C010 5962-38267 01/03/05/07	1 Mbit	128 Kbits x 8	4.5–5.5V	10k Write Cycles	120, 150, 200, 250	CERDIP (32D)	CLCC (32L)	FLATPACK (32F)
AT28C010E				100k Write Cycles	120, 150	CERDIP (32D)	CLCC (32L)	FLATPACK (32F)

Industrial

Root Part Number	Density	Organization	V _{CC} (V)	Endurance (10yr Data Retention)	Access Speed (ns)	Package					
AT28BV64B	64 Kbits	8 Kbits x 8	2.7–3.6	10k Write Cycles	200	PLCC (32J)	–	SOIC (28S)	TSOP (28T)		
AT28BV256	256 Kbits	32 Kbits x 8		10k Write Cycles	200	PLCC (32J)	–	SOIC (28S)	TSOP (28T)		
AT28C64B	64 Kbits	8 Kbits x 8	4.5–5.5	10k Write Cycles	150	PLCC (32J)	PDIP (28P)	SOIC (28S)	TSOP (28T)		
AT28C256	256 Kbits	32 Kbits x 8		10k Write Cycles	150	PLCC (32J)	PDIP (28P)	SOIC (28S)	TSOP (28T)		
AT28C256E				100k Write Cycles	150	PLCC (32J)	–	SOIC (28S)	TSOP (28T)		
AT28C256F				10k Write Cycles	150 (3 ms Fast Write Option)	PLCC (32J)	–	SOIC (28S)	TSOP (28T)		
AT28C010				1 Mbit	128 Kbits x 8	10k Write Cycles	120, 150	PLCC (32J)	–	–	TSOP (32T)
AT28C010E	100k Write Cycles	120, 150				PLCC (32J)	–	–	TSOP (32T)		
AT28HC64B	64 Kbits	8 Kbits x 8		4.5–5.5	10k Write Cycles	70, 90, 120	PLCC (32J)	–	SOIC (28S)	TSOP (28T)	
AT28HC64BF						70, 90, 120 (2 ms Fast Write Option)	PLCC (32J)	–	SOIC (28S)	TSOP (28T)	
AT28HC256	256 Kbits	32 Kbits x 8		4.5–5.5	10k Write Cycles	70, 90, 120	PLCC (32J)	–	SOIC (28S)	TSOP (28T)	
AT28HC256E						100k Write Cycles	90, 120	PLCC (32J)	–	SOIC (28S)	TSOP (28T)
AT28HC256F						10k Write Cycles	90 (3 ms Fast Write Option)	PLCC (32J)	–	SOIC (28S)	TSOP (28T)
AT28LV010						1 Mbit	128 Kbits x 8	3.0–3.6	10k Write Cycles	200	PLCC (32J)

EERAM is SRAM with EEPROM backup in a single, low-cost, low-power chip, creating a solution that is more reliable than a battery-backed SRAM at a lower cost than FRAM.

Key Features

- Serial interface: I²C Bus, 1 MHz
- Unlimited E/W cycles on SRAM block
 - Zero write time
 - External auto save trigger
- Data backed up in EEPROM automatically at power down or V_{DD} fail
- Data recalled from EEPROM automatically at power-up
- Auto save time < 40 ns (needs external cap)
 - Connect a (~20 μF) capacitor to pin 1
- Low power
 - 1 mA/3 mA max. read/write
 - <1 μA standby current
- 8-pin packages (SOIC, PDIP, TSSOP)
- Auto-EEPROM backed—most reliable (no battery needed)
- Single chip to replace RAM, EEPROM and FRAM in application
- Automotive Grade 1 with PPAP support

Typical Applications

- Metering
- Printers
- Applications needing unlimited writes/endurance
- Applications needing zero wait states

4K/16K I²C EERAM Products

Product	Density	V _{cc} Range Max.	Clock Frequency	Temperature Ranges	Packages
47104	4 Kbits	2.7–3.6V	1 MHz	–40 to +85°C –40 to +125°C	PDIP, SOIC, TSSOP
47C04	4 Kbits	4.5–5.5V	1 MHz	–40 to +85°C –40 to +125°C	PDIP, SOIC, TSSOP
47116	16 Kbits	2.7–3.6V	1 MHz	–40 to +85°C –40 to +125°C	PDIP, SOIC, TSSOP
47C16	16 Kbits	4.5–5.5V	1 MHz	–40 to +85°C –40 to +125°C	PDIP, SOIC, TSSOP

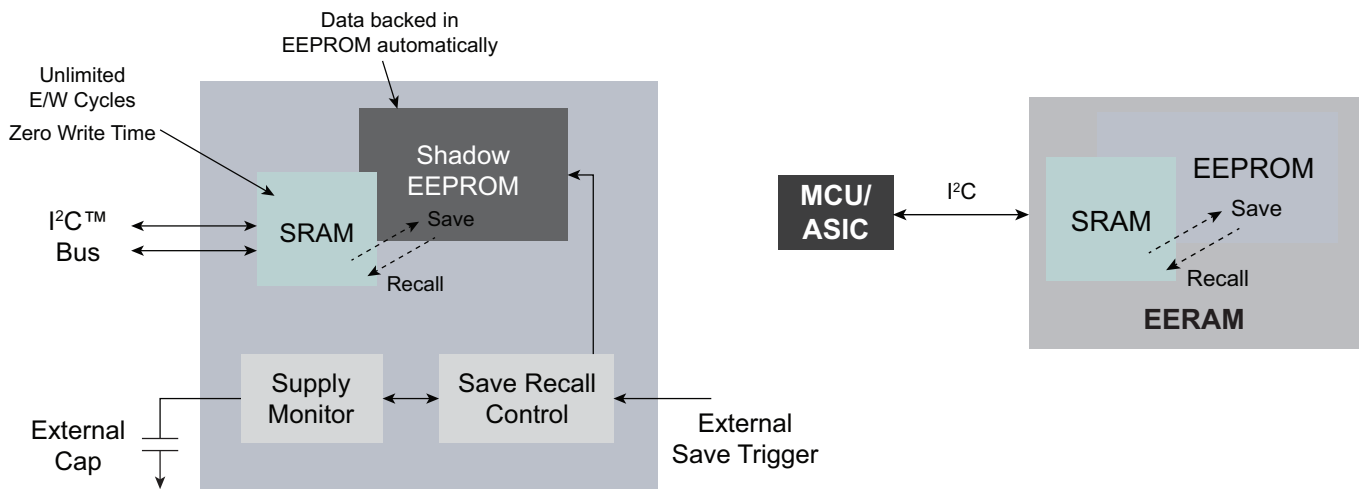

Microchip Technology has developed industry-leading processes for each step in the design, manufacturing and testing phases of its memory products and has become one of the most respected leaders in supply of these devices to the automotive industry worldwide.

Temperature Range

Now offering I²C and SPI Serial EEPROMs with optional range from -55 to 150°C.

- Automotive turbo chargers and exhaust gas recirculation
- Automotive fan motors, air valves, flaps and spark plugs
- Areas under the vehicle hood

Automotive Grade

- ISO TS-16949-compliant (inc. VDA6.1) quality manufacturing systems
- Restricted site assembly
- Production Parts Approval Process (PPAP)
- Exceeds AEC Q-100 product qualification requirements
- Special screening and test methods including Maverick lot testing
- Long product life cycle in support of automotive industry 15 year supply requirement

Serial SRAM

Looking for RAM also? Microchip's SPI Serial SRAM products offer:

- A quick and easy way to add external RAM
- 4-pin SPI interface
- 20 MHz clock speed
- No write cycle time

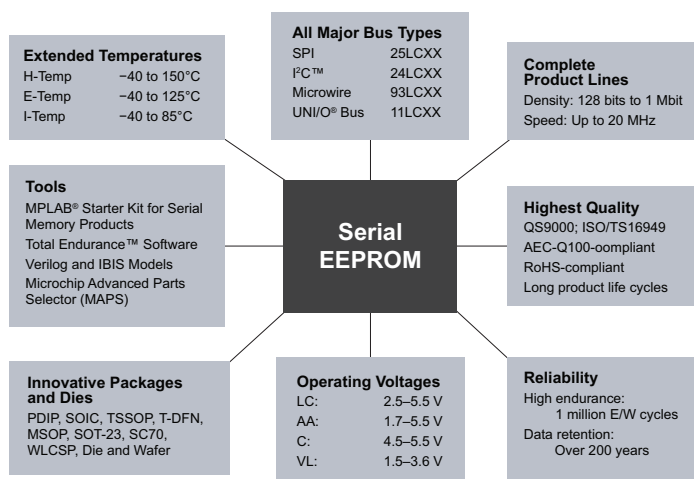

Automotive Memory Products

Flash

Unique Flash Cell Design

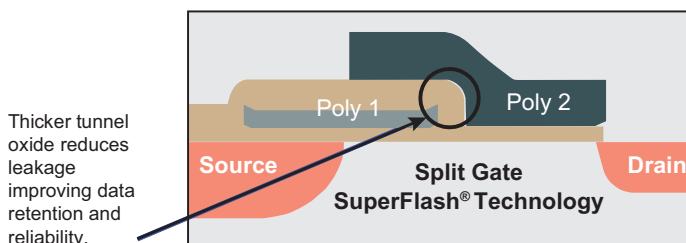

EEPROM: Robust Design

- ESD protection
 - > 4000 V Human Body Model (HBM)
 - > 400 V Machine Model (MM)
 - > 1000 V Charged Device Model
- Latch-up protection > 200 mA on all pins
- ESD induced latch-up > 100 V (MM) on V_{DD}; > 400 V on all I/O
- > 1 M cycles endurance and > 200 years data retention
- Up to 150°C operation (read and writes)
- Power-On Reset (POR) and Brown-Out Reset (BOR)
 - Effective protection against noisy automotive environments
 - Eliminates false writes
- Schmitt Trigger input filters for noise reduction

Complete traceability including die location on wafer

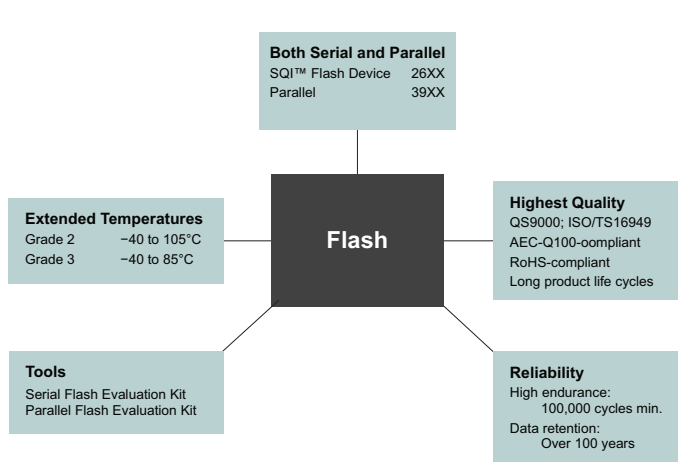

Development Tools

Reduce development time and cost with Microchip's development tools. Competitive market conditions force businesses to examine every aspect of their product life cycle to maximize productivity and minimize expense. Easy-to-learn, low-cost common development tools are one way to reduce risk and get to market faster.

MPLAB® Starter Kit for Serial Memory Products (DV243003)



Reduce time to market and create a rock-solid design using the MPLAB Starter Kit for Serial Memory Products. It includes everything necessary to quickly develop a robust and reliable Serial

EEPROM design, and greatly reduces the time required for system integration and hardware/software fine-tuning.

- 3.3 V and 5.0 V on-board voltage selection
- Supports Microchip UNI/O bus, I²C, SPI and Microwire Serial EEPROMs
- 1.8V to 5.5V external voltage support
- Includes free copy of MPLAB X IDE
- USB interconnect

Serial SuperFlash Kit 2 (AC243008)



The Serial SuperFlash Kit 2 allows you to evaluate Serial Flash and quickly develop and test firmware using known good hardware. The kit includes three Serial Flash boards each having a serial flash soldered on it. The Serial Flash device included are SST25PF040C, SST25VF020B and SST25WF080B.

SQI SuperFlash Kit 1 (AC243009)

The SQI SuperFlash Kit 1 allows you to evaluate SQI Flash and quickly develop and test firmware using known good hardware. The kit includes three Serial flash boards each having a SQI flash soldered on it. The SQI Flash device included are SST26VF064B, SST26VF032B and SST26WF016B.

Serial EEPROM Plug-In Module PICtail™ Board Pack (AC243003)

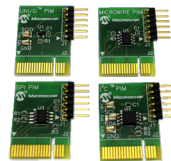

The Serial EEPROM Plug-In Module PICtail Board Pack is a series of boards designed around Microchip's Serial EEPROM devices. The boards are designed to interface with the PICtail Plus connector as well as the MPLAB Starter Kit for

Serial Memory Products and the PICkit™ 3 board, allowing you to get started right out of the box.

- Plug-and-play with PICtail Plus connector and PICkit 3 connector
- Test points for oscilloscope connections for firmware debugging (I²C and UNI/O only)
- Microwire Buses are included for maximum flexibility in development of your application

Parallel SuperFlash Technology Kit 1 (AC243006-1)

The Parallel Flash PICtail Plus Daughter Board is an evaluation board designed to interface with the PICtail Plus connector found on the Explorer 16 Development Board. The Parallel SuperFlash Technology Kit 1 contains two Parallel Flash PICtail Plus Daughter Boards. Each board has a parallel Flash device soldered on it. The parallel Flash devices included are SST38VF6401 and SST39VF1601C.

Support

Microchip is committed to supporting its customers in developing products faster and more efficiently. We maintain a worldwide network of field applications engineers and technical support ready to provide product and system assistance. For more information, please visit www.microchip.com:

- Technical Support: www.microchip.com/support
- Evaluation samples of any Microchip device: www.microchip.com/sample
- Knowledge base and peer help: www.microchip.com/forums
- Sales and Global Distribution: www.microchip.com/sales

Training

If additional training interests you, Microchip offers several resources including in-depth technical training and reference material, self-paced tutorials and significant online resources.

- Overview of Technical Training Resources: www.microchip.com/training
- MASTERS Conferences: www.microchip.com/masters
- Developer Help Website: www.microchip.com/developerhelp
- Technical Training Centers: www.microchip.com/seminars

Sales Office Listing

AMERICAS

Atlanta, GA
Tel: 678-957-9614

Austin, TX
Tel: 512-257-3370

Boston, MA
Tel: 774-760-0087

Chandler, AZ (HQ)
Tel: 480-792-7200

Chicago, IL
Tel: 630-285-0071

Dallas, TX
Tel: 972-818-7423

Detroit, MI
Tel: 248-848-4000

Houston, TX
Tel: 281-894-5983

Indianapolis, IN
Tel: 317-773-8323
Tel: 317-536-2380

Los Angeles, CA
Tel: 949-462-9523
Tel: 951-273-7800

Raleigh, NC
Tel: 919-844-7510

New York, NY
Tel: 631-435-6000

San Jose, CA
Tel: 408-735-9110
Tel: 408-436-4270

Canada - Toronto
Tel: 905-695-1980

EUROPE

Austria - Wels
Tel: 43-7242-2244-39

Denmark - Copenhagen
Tel: 45-4450-2828

Finland - Espoo
Tel: 358-9-4520-820

France - Paris
Tel: 33-1-69-53-63-20

Germany - Garching
Tel: 49-8931-9700

Germany - Haan
Tel: 49-2129-3766-400

Germany - Heilbronn
Tel: 49-7131-67-3636

Germany - Karlsruhe
Tel: 49-721-62537-0

Germany - Munich
Tel: 49-89-627-144-0

Germany - Rosenheim
Tel: 49-8031-354-560

EUROPE

Israel - Ra'anana
Tel: 972-9-744-7705

Italy - Milan
Tel: 39-0331-742611

Italy - Padova
Tel: 39-049-7625286

Netherlands - Drunen
Tel: 31-416-690399

Norway - Trondheim
Tel: 47-7289-7561

Poland - Warsaw
Tel: 48-22-3325737

Romania - Bucharest
Tel: 40-21-407-87-50

Spain - Madrid
Tel: 34-91-708-08-90

Sweden - Gothenberg
Tel: 46-31-704-60-40

Sweden - Stockholm
Tel: 46-8-5090-4654

UK - Wokingham
Tel: 44-118-921-5800

ASIA/PACIFIC

Australia - Sydney
Tel: 61-2-9868-6733

China - Beijing
Tel: 86-10-8569-7000

China - Chengdu
Tel: 86-28-8665-5511

China - Chongqing
Tel: 86-23-8980-9588

China - Dongguan
Tel: 86-769-8702-9880

China - Guangzhou
Tel: 86-20-8755-8029

China - Hangzhou
Tel: 86-571-8792-8115

China - Hong Kong SAR
Tel: 852-2943-5100

China - Nanjing
Tel: 86-25-8473-2460

China - Qingdao
Tel: 86-532-8502-7355

China - Shanghai
Tel: 86-21-3326-8000

China - Shenyang
Tel: 86-24-2334-2829

China - Shenzhen
Tel: 86-755-8864-2200

China - Wuhan
Tel: 86-27-5980-5300

China - Xiamen
Tel: 86-592-2388138

China - Xian
Tel: 86-29-8833-7252

ASIA/PACIFIC

China - Zhuhai
Tel: 86-756-321-0040

India - Bangalore
Tel: 91-80-3090-4444

India - New Delhi
Tel: 91-11-4160-8631

India - Pune
Tel: 91-20-4121-0141

Japan - Osaka
Tel: 81-6-6152-7160

Japan - Tokyo
Tel: 81-3-6880-3770

Korea - Daegu
Tel: 82-53-744-4301

Korea - Seoul
Tel: 82-2-554-7200

Malaysia - Kuala Lumpur
Tel: 60-3-7651-7906

Malaysia - Penang
Tel: 60-4-227-8870

Philippines - Manila
Tel: 63-2-634-9065

Singapore
Tel: 65-6334-8870

Taiwan - Hsin Chu
Tel: 886-3-577-8366

Taiwan - Kaohsiung
Tel: 886-7-213-7830

Taiwan - Taipei
Tel: 886-2-2508-8600

Thailand - Bangkok
Tel: 66-2-694-1351

Vietnam - Ho Chi Minh
Tel: 84-28-5448-2100

10/31/17



www.microchip.com

Microchip Technology Inc. | 2355 W. Chandler Blvd. | Chandler AZ, 85224-6199