

Features:

- Special passivation for moisture sensitive applications
- Absolute TCR's to 15 ppm/°C
- Test proven immunity to humidity and moisture corrosion
- Absolute tolerances to 0.1%
- Ideal replacement for costly Tantalum Nitride resistors
- Qualified to AEC-Q200
- E196 values are not marked
- 100% RoHS compliant and lead free without exemption
- Halogen free
- REACH compliant
- For anti-sulfur version, refer to [RNCS-AS specification](#)

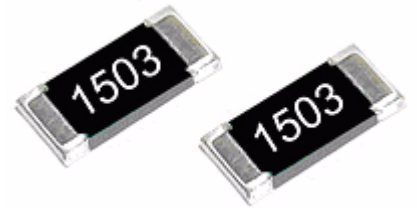

The RNCS/RNCH series employs a special manufacturing process to ensure high power, high precision, ultra-stable performance, and long life in the harshest environments. In moisture comparison testing, the RNCS/RNCH series outperformed conventionally passivated Nichrome chip resistors and demonstrated the anti-corrosive claims characterized by Tantalum Nitride resistor products.

Electrical Specifications - RNCS					
Type/Code	Power Rating (W) @ 70°C	Maximum Working Voltage (V) ⁽¹⁾	Maximum Overload Voltage (V)	TCR (ppm/°C)	Ohmic Range (Ω) and Tolerance
					0.1%, 0.25%, 0.5%
RNCS0402	0.063	25	50	±15	49.9 - 12K
				±25	25 - 25K
				±50	
RNCS0603	0.063	50	100	±15	25 - 332K
				±25	
				±50	
RNCS0805	0.1	100	200	±15 ±25 ±50	10 - 1M
RNCS1206	0.125	150	300	±15 ±25 ±50	10 - 1M
RNCS2010	0.25 (0.5) ⁽²⁾	150	300	±15	25 - 1M
				±25	10 - 1M
				±50	
RNCS2512	0.5 (1) ⁽²⁾	150	300	±15	25 - 1M
				±25	10 - 1M
				±50	

(1) Lesser of $\sqrt{P \cdot R}$ or maximum working voltage

(2) Higher power rating for each package size is valid if ambient temperature $\leq 80^\circ\text{C}$ and terminal temperature $\leq 105^\circ\text{C}$

Electrical Specifications - RNCH					
Type/Code	Power Rating (W) @ 70 °C	Maximum Working Voltage (V) ⁽¹⁾	Maximum Overload Voltage (V)	TCR (ppm/°C)	Ohmic Range (Ω) and Tolerance
					0.1%, 0.25%, 0.5%
RNCH0603	0.1	75	150	±15 ±25 ±50	25 - 220K
RNCH0805	0.25	150	300	±15 ±25 ±50	25 - 680K
RNCH1206	0.33	200	400	±15 ±25 ±50	25 - 1M

(1) Lesser of $\sqrt{P \cdot R}$ or maximum working voltage

Mechanical Specifications

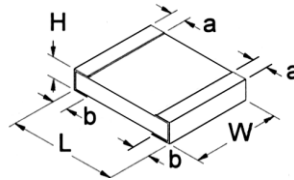

Type/Code	Weight (g) (1000 pc.)	L Body Length	W Body Width	H Body Height	a Top Termination	b Bottom Termination	Unit
RNCS0402	0.55	0.039 ± 0.002 1.00 ± 0.05	0.020 ± 0.002 0.50 ± 0.05	0.012 ± 0.002 0.30 ± 0.05	0.008 ± 0.004 0.20 ± 0.10	0.008 ± 0.004 0.20 ± 0.10	inches mm
RNCS0603 RNCH0603	1.85	0.061 ± 0.008 1.55 ± 0.20	0.031 ± 0.008 0.80 ± 0.20	0.018 ± 0.004 0.45 ± 0.10	0.012 ± 0.008 0.30 ± 0.20	0.012 ± 0.008 0.30 ± 0.20	inches mm
RNCS0805 RNCH0805	4.76	0.079 ± 0.008 2.00 ± 0.20	0.049 ± 0.008 1.25 ± 0.20	0.022 ± 0.004 0.55 ± 0.10	0.012 ± 0.008 0.30 ± 0.20	0.016 ± 0.010 0.40 ± 0.25	inches mm
RNCS1206 RNCH1206	9.11	0.120 ± 0.008 3.05 ± 0.20	0.061 ± 0.008 1.55 ± 0.20	0.022 ± 0.004 0.55 ± 0.10	0.017 ± 0.012 0.42 ± 0.30	0.014 ± 0.010 0.35 ± 0.25	inches mm
RNCS2010	23.82	0.193 ± 0.006 4.90 ± 0.15	0.094 ± 0.006 2.40 ± 0.15	0.022 ± 0.004 0.55 ± 0.10	0.024 ± 0.012 0.60 ± 0.30	0.020 ± 0.010 0.50 ± 0.25	inches mm
RNCS2512	38.46	0.248 ± 0.006 6.30 ± 0.15	0.122 ± 0.006 3.10 ± 0.15	0.022 ± 0.004 0.55 ± 0.10	0.024 ± 0.012 0.60 ± 0.30	0.020 ± 0.010 0.50 ± 0.25	inches mm

Performance Characteristics

Test	Test Method	Test Specification		Test Condition
		0603, 0805, 1206, 2010, 2512	0402	
Short Time Overload	JIS-C-5201-1 4.13	≤ ± 0.02% ≤ ± 0.2% for high power rating	≤ ± 0.1%	RCWV * 2.5 or Max. overload voltage whichever is lower for 2 seconds
Endurance	MIL-STD-202 Method 108A	≤ ± 0.05% ≤ ± 0.25% for high power rating	≤ ± 0.25%	70 ± 2°C, RCWV for 1000 hours with 1.5 hours "ON" and 0.5 hour "OFF"
Damp Heat with Load	MIL-STD-202 Method 103B	≤ ± 0.05% ≤ ± 0.25% for high power rating	≤ ± 0.5%	40 ± 2°C, 90 ~ 95% R.H., RCWV for 1000 hours with 1.5 hours "ON" and 0.5 hour "OFF"
Solderability	MIL-STD-202 Method 208H	95% min. coverage		245 ± 5°C for 3 seconds
Resistance to Soldering Heat	MIL-STD-202 Method 210E	≤ ± 0.02%	≤ ± 0.1%	260 ± 5°C for 10 seconds
Thermal Shock	MIL-STD-202 Method 107G	≤ ± 0.02%	≤ ± 0.1%	-55°C ~ 150°C, 100 cycles

RCWV (Rated Continuous Work Voltage) = $\sqrt{P \cdot R}$ or Max. Operating voltage whichever is lower

Operating temperature range is -55°C to +155°C

Storage Temperature is 15°C to 28°C. Humidity < 80% R.H.

Power Derating Curve:

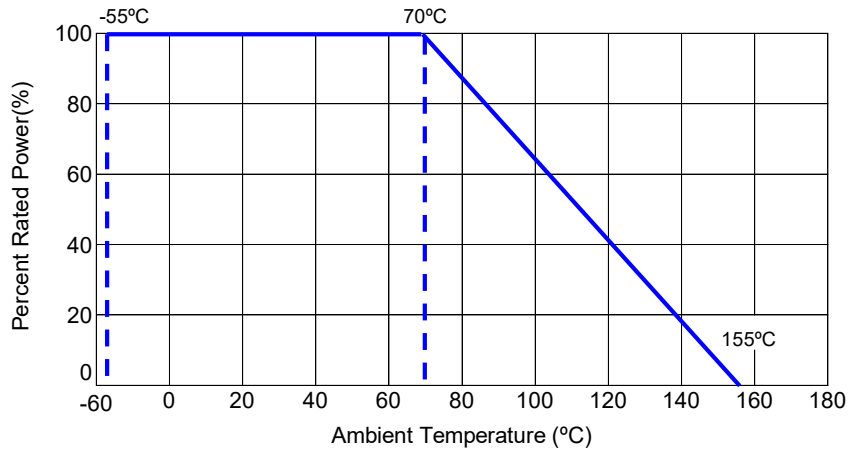

Soldering Condition:

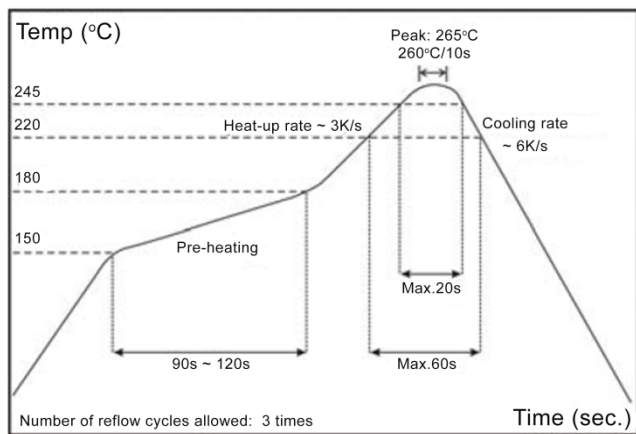

IR Reflow Soldering

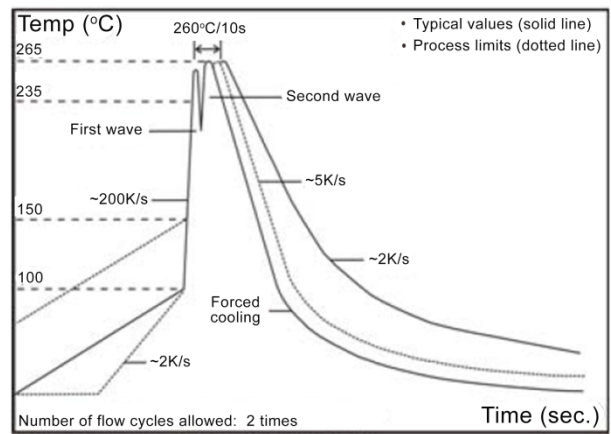

Wave Soldering (Flow Soldering)

- (1) Time of IR reflow soldering at maximum temperature point 260°C: 10 seconds
- (2) Time of wave soldering at maximum temperature point 260°C: 10 seconds
- (3) Time of soldering iron at maximum temperature point 410°C: 5 seconds

Reel Specifications

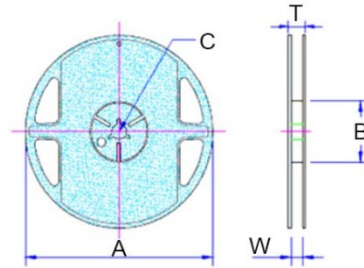

Type/Code	A	B	C	W	T	Unit
RNCS0402	7.008 ± 0.039 178.00 ± 1.00	2.362 ± 0.039 60.00 ± 1.00	0.531 ± 0.028 13.50 ± 0.70	0.374 ± 0.039 9.50 ± 1.00	0.453 ± 0.039 11.50 ± 1.00	inches mm
RNCS0603	7.008 ± 0.039 178.00 ± 1.00	2.362 ± 0.039 60.00 ± 1.00	0.531 ± 0.028 13.50 ± 0.70	0.374 ± 0.039 9.50 ± 1.00	0.453 ± 0.039 11.50 ± 1.00	inches mm
RNCS0805	7.008 ± 0.039 178.00 ± 1.00	2.362 ± 0.039 60.00 ± 1.00	0.531 ± 0.028 13.50 ± 0.70	0.374 ± 0.039 9.50 ± 1.00	0.453 ± 0.039 11.50 ± 1.00	inches mm
RNCS1206	7.008 ± 0.039 178.00 ± 1.00	2.362 ± 0.039 60.00 ± 1.00	0.531 ± 0.028 13.50 ± 0.70	0.374 ± 0.039 9.50 ± 1.00	0.453 ± 0.039 11.50 ± 1.00	inches mm
RNCS2010	7.008 ± 0.039 178.00 ± 1.00	2.362 ± 0.039 60.00 ± 1.00	0.531 ± 0.028 13.50 ± 0.70	0.531 ± 0.039 13.50 ± 1.00	0.610 ± 0.039 15.50 ± 1.00	inches mm
RNCS2512	7.008 ± 0.039 178.00 ± 1.00	2.362 ± 0.039 60.00 ± 1.00	0.531 ± 0.028 13.50 ± 0.70	0.531 ± 0.039 13.50 ± 1.00	0.610 ± 0.039 15.50 ± 1.00	inches mm

Packaging Specifications - Paper Tape

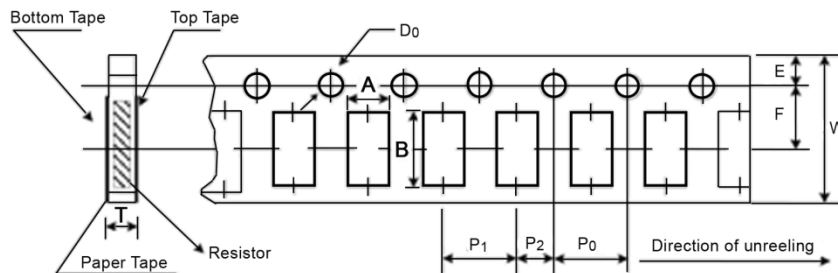

Type/Code	A	B	W	E	F	Unit
RNCS0402	0.028 ± 0.002 0.70 ± 0.05	0.046 ± 0.002 1.16 ± 0.05	0.315 ± 0.004 8.00 ± 0.10	0.069 ± 0.020 1.75 ± 0.50	0.138 ± 0.002 3.50 ± 0.05	inches mm
RNCS0603	0.043 ± 0.002 1.10 ± 0.05	0.075 ± 0.002 1.90 ± 0.05	0.315 ± 0.004 8.00 ± 0.10	0.069 ± 0.002 1.75 ± 0.05	0.138 ± 0.002 3.50 ± 0.05	inches mm
RNCS0805	0.063 ± 0.002 1.60 ± 0.05	0.093 ± 0.002 2.37 ± 0.05	0.315 ± 0.004 8.00 ± 0.10	0.069 ± 0.002 1.75 ± 0.05	0.138 ± 0.002 3.50 ± 0.05	inches mm
RNCS1206	0.079 ± 0.002 2.00 ± 0.05	0.140 ± 0.002 3.55 ± 0.05	0.315 ± 0.004 8.00 ± 0.10	0.069 ± 0.002 1.75 ± 0.05	0.138 ± 0.002 3.50 ± 0.05	inches mm
Type/Code	P0	P1	P2	D0	T	Unit
RNCS0402	0.157 ± 0.004 4.00 ± 0.10	0.079 ± 0.002 2.00 ± 0.05	0.079 ± 0.002 2.00 ± 0.05	0.061 ± 0.002 1.55 ± 0.05	0.016 ± 0.001 0.40 ± 0.03	inches mm
RNCS0603	0.157 ± 0.004 4.00 ± 0.10	0.157 ± 0.004 4.00 ± 0.10	0.079 ± 0.002 2.00 ± 0.05	0.061 ± 0.002 1.55 ± 0.05	0.024 ± 0.001 0.60 ± 0.03	inches mm
RNCS0805	0.157 ± 0.004 4.00 ± 0.10	0.157 ± 0.004 4.00 ± 0.10	0.079 ± 0.002 2.00 ± 0.05	0.061 ± 0.002 1.55 ± 0.05	0.030 ± 0.002 0.75 ± 0.05	inches mm
RNCS1206	0.157 ± 0.004 4.00 ± 0.10	0.157 ± 0.004 4.00 ± 0.10	0.079 ± 0.002 2.00 ± 0.05	0.061 ± 0.002 1.55 ± 0.05	0.030 ± 0.002 0.75 ± 0.05	inches mm

Peel Force of Top Cover Paper Tape

The peel speed shall be about 300 mm/min \pm 5%
The peel force of top cover tape shall be between 8gf to 60gf

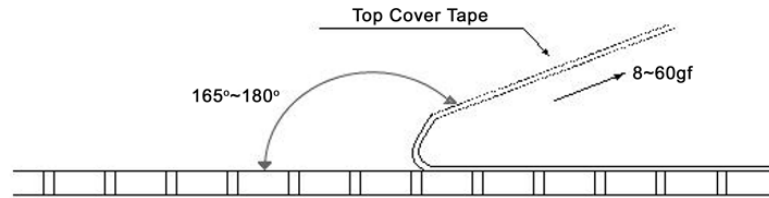

Packaging Specifications – Embossed Plastic Tape

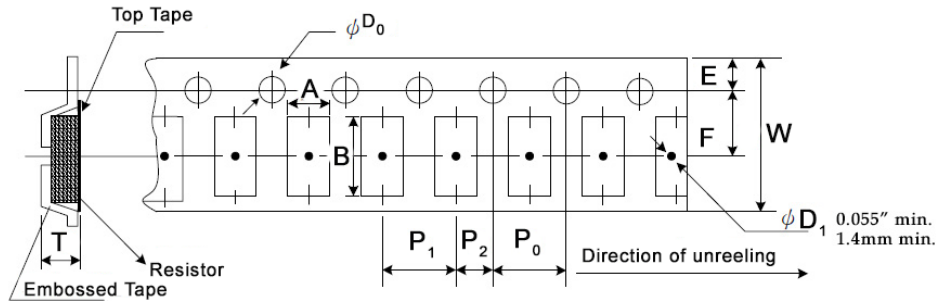

Type/Code	A	B	W	E	F	Unit
RNCS2010	0.112 \pm 0.004	0.215 \pm 0.004	0.472 \pm 0.004	0.069 \pm 0.004	0.217 \pm 0.002	inches
	2.85 \pm 0.10	5.45 \pm 0.10	12.00 \pm 0.10	1.75 \pm 0.10	5.50 \pm 0.05	mm
RNCS2512	0.134 \pm 0.004	0.262 \pm 0.004	0.472 \pm 0.004	0.069 \pm 0.004	0.217 \pm 0.002	inches
	3.40 \pm 0.10	6.65 \pm 0.10	12.00 \pm 0.10	1.75 \pm 0.10	5.50 \pm 0.05	mm
Type/Code	P0	P1	P2	D0	T	Unit
RNCS2010	0.157 \pm 0.002	0.157 \pm 0.004	0.079 \pm 0.002	0.059 \pm 0.004	0.039 \pm 0.008	inches
	4.00 \pm 0.05	4.00 \pm 0.10	2.00 \pm 0.05	1.50 \pm 0.10	1.00 \pm 0.20	mm
RNCS2512	0.157 \pm 0.002	0.157 \pm 0.004	0.079 \pm 0.002	0.059 \pm 0.004	0.039 \pm 0.008	inches
	4.00 \pm 0.05	4.00 \pm 0.10	2.00 \pm 0.05	1.50 \pm 0.10	1.00 \pm 0.20	mm

Peel Force of Top Cover Plastic Tape

The peel speed shall be about 300 mm/min \pm 5%
The peel force of top cover tape shall be between 20gf to 80gf

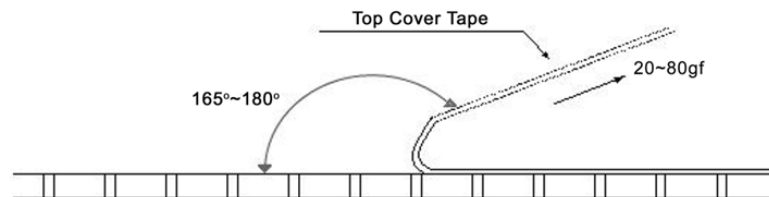

Recommended Pad Layout				
Type/Code	a	b	c	Unit
RNCS0402	0.020	0.020	0.024 ± 0.008	inches
	0.50	0.50	0.60 ± 0.20	mm
RNCS0603	0.031	0.039	0.035 ± 0.008	inches
	0.80	1.00	0.90 ± 0.20	mm
RNCS0805	0.039	0.039	0.053 ± 0.008	inches
	1.00	1.00	1.35 ± 0.20	mm
RNCS1206	0.079	0.045	0.067 ± 0.008	inches
	2.00	1.15	1.70 ± 0.20	mm
RNCS2010	0.142	0.055	0.098 ± 0.008	inches
	3.60	1.40	2.50 ± 0.20	mm
RNCS2512	0.193	0.063	0.122 ± 0.008	inches
	4.90	1.60	3.10 ± 0.20	mm

RoHS Compliance

Stackpole Electronics has joined the worldwide effort to reduce the amount of lead in electronic components and to meet the various regulatory requirements now prevalent, such as the European Union’s directive regarding “Restrictions on Hazardous Substances” (RoHS 3). As part of this ongoing program, we periodically update this document with the status regarding the availability of our compliant components. All our standard part numbers are compliant to EU Directive 2011/65/EU of the European Parliament as amended by Directive (EU) 2015/863/EU as regards the list of restricted substances.

RoHS Compliance Status						
Standard Product Series	Description	Package / Termination Type	Standard Series RoHS Compliant	Lead-Free Termination Composition	Lead-Free Mfg. Effective Date (Std Product Series)	Lead-Free Effective Date Code (YY/WW)
RNCH	Anti-Corrosive Tantalum Nitride Replacement Surface Mount Chip Resistor	SMD	YES	100% Matte Sn over Ni	Always	Always
RNCS	Anti-Corrosive Tantalum Nitride Replacement Surface Mount Chip Resistor	SMD	YES	100% Matte Sn over Ni	May-04	04/18

“Conflict Metals” Commitment

We at Stackpole Electronics, Inc. are joined with our industry in opposing the use of metals mined in the “conflict region” of the eastern Democratic Republic of the Congo (DRC) in our products. Recognizing that the supply chain for metals used in the electronics industry is very complex, we work closely with our own suppliers to verify to the extent possible that the materials and products we supply do not contain metals sourced from this conflict region. As such, we are in compliance with the requirements of Dodd-Frank Act regarding Conflict Minerals.

Compliance to “REACH”

We certify that all passive components supplied by Stackpole Electronics, Inc. are SVHC (Substances of Very High Concern) free and compliant with the requirements of EU Directive 1907/2006/EC, “The Registration, Evaluation, Authorization and Restriction of Chemicals”, otherwise referred to as REACH. Contact us for complete list of REACH Substance Candidate List.

Environmental Policy

It is the policy of Stackpole Electronics, Inc. (SEI) to protect the environment in all localities in which we operate. We continually strive to improve our effect on the environment. We observe all applicable laws and regulations regarding the protection of our environment and all requests related to the environment to which we have agreed. We are committed to the prevention of all forms of pollution.

How to Order

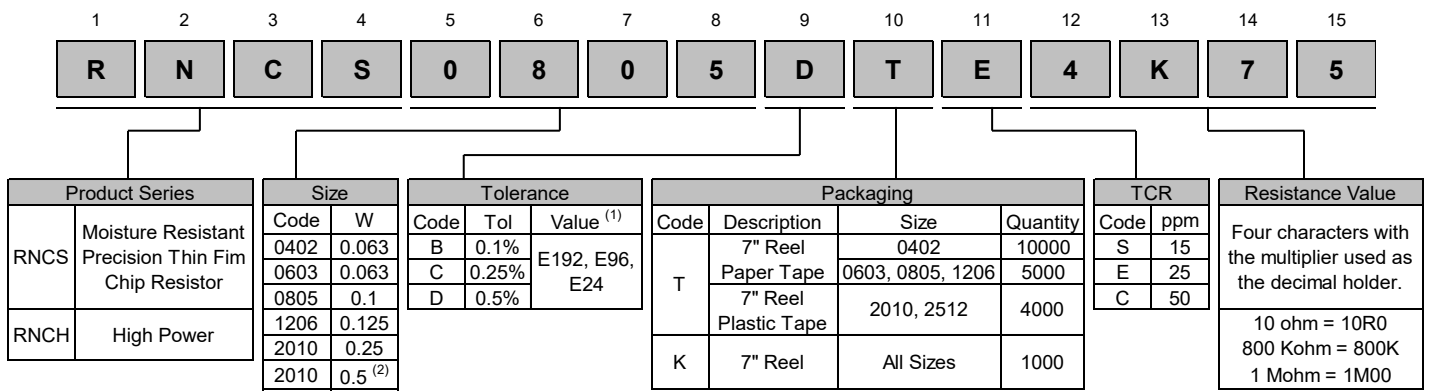

(1) E192 values are not marked, and may be subject to 20K MOQ
 (2) Higher power rating is valid if ambient temperature ≤ 80°C and terminal temperature ≤ 105°C