



Datasheet

Part No:
PCS.07.A

Description:
Low Profile Cellular SMD Dielectric Antenna
824~960MHz/1710~2170MHz

Features:
High Efficiency Multi-Band SMD antenna
Low profile 35mm * 7mm * 3mm
CE Certified
RoHS & Reach Compliant



1. Introduction	3
2. Specifications	4
3. Antenna Characteristics	6
4. Radiation Patterns	8
5. Mechanical Drawing	10
6. Evaluation Board Drawing	11
7. Footprint	12
8. Matching Circuit	13
9. Solder Reflow Recommendations	14
10. Packaging	15
11. Application Note	17
<hr/>	
Changelog	20

Taoglas makes no warranties based on the accuracy or completeness of the contents of this document and reserves the right to make changes to specifications and product descriptions at any time without notice. Taoglas reserves all rights to this document and the information contained herein. Reproduction, use or disclosure to third parties without express permission is strictly prohibited.



1. Introduction



The PCS.07.A is a low profile SMT cellular antenna designed for direct SMT mount on the device PCB. It provides highest efficiency in very small factor 35*7*3mm. It is more resistant to detuning compared to other antenna integrations. If tuning is required it can be tuned for the device environment, while there is no need for new tooling. Its rectangular shape and very small size makes it very easy to integrate – can be mounted directly on the edge of the PCB board.

The PCS.07 antenna is suitable for lower cost cellular applications and is especially suitable for telematics and automotive sector. If higher efficiency or improved radiated spurious emissions are required, especially on smaller ground-planes, please use our PA series antennas, PA.26 or PA.710. For further information, please contact your regional Taoglas customer support team.

2. Specifications

Cellular					
Frequency (MHz)	824~896	880~960	1710~1880	1850~1990	1920~2170
Peak Gain (dBi)					
On EVB	-1.96	-1.77	2.90	2.83	2.57
Average Gain (dB)					
On EVB	-4.68	-4.44	-2.50	-2.68	-2.42
Efficiency (%)					
On EVB	32.02	31.06	45.14	52.82	50.11
Return Loss (dB)					
On EVB	< -3	< -4	< -5	< -7	< -6
Impedance	50Ω				
Polarization	Linear				
Radiation Pattern	Omni				
Mechanical					
Antenna Dimensions	35mm x 7mm x 3mm				
Material	Polymer				
Soldering Type	SMT through Reflow				
Environmental					
Temperature Range	-40°C to 85°C				
Moisture Sensitivity Level (MSL)	3 (168 Hours)				

5G/4G Bands			
Band Number	5G NR / FR1 / LTE / LTE-Advanced / WCDMA / HSPA / HSPA+ / TD-SCDMA		
	Uplink	Downlink	Covered
1	UL: 1920 to 1980	DL: 2110 to 2170	✓
2	UL: 1850 to 1910	DL: 1930 to 1990	✓
3	UL: 1710 to 1785	DL: 1805 to 1880	✓
4	UL: 1710 to 1755	DL: 2110 to 2155	✓
5	UL: 824 to 849	DL: 869 to 894	✓
7	UL: 2500 to 2570	DL: 2620 to 2690	✗
8	UL: 880 to 915	DL: 925 to 960	✓
9	UL: 1749.9 to 1784.9	DL: 1844.9 to 1879.9	✓
11	UL: 1427.9 to 1447.9	DL: 1475.9 to 1495.9	✗
12	UL: 699 to 716	DL: 729 to 746	✗
13	UL: 777 to 787	DL: 746 to 756	✗
14	UL: 788 to 798	DL: 758 to 768	✗
17	UL: 704 to 716	DL: 734 to 746	✗
18	UL: 815 to 830	DL: 860 to 875	✓
19	UL: 830 to 845	DL: 875 to 890	✓
20	UL: 832 to 862	DL: 791 to 821	✓
21	UL: 1447.9 to 1462.9	DL: 1495.9 to 1510.9	✗
22	UL: 3410 to 3490	DL: 3510 to 3590	✗
23	UL: 2000 to 2020	DL: 2180 to 2200	✓
24	UL: 1625.5 to 1660.5	DL: 1525 to 1559	✗
25	UL: 1850 to 1915	DL: 1930 to 1995	✓
26	UL: 814 to 849	DL: 859 to 894	✓
27	UL: 807 to 824	DL: 852 to 869	✓
28	UL: 703 to 748	DL: 758 to 803	✗
29	UL: -	DL: 717 to 728	✗
30	UL: 2305 to 2315	DL: 2350 to 2360	✗
31	UL: 452.5 to 457.5	DL: 462.5 to 467.5	✗
32	UL: -	DL: 1452 – 1496	✗
35		1850 to 1910	✓
38		2570 to 2620	✗
39		1880 to 1920	✓
40		2300 to 2400	✗
41		2496 to 2690	✗
42		3400 to 3600	✗
43		3600 to 3800	✗
48		3550 to 3700	✗
66	UL: 1710-1780	DL: 2110-2200	✓
71		617 to 698	✗
74/75/76		1427 to 1518	✗
77		3300 to 4200	✗
78		3300 to 3800	✗
79		4400 to 5000	✗

3. Antenna Characteristics

3.1 Return Loss

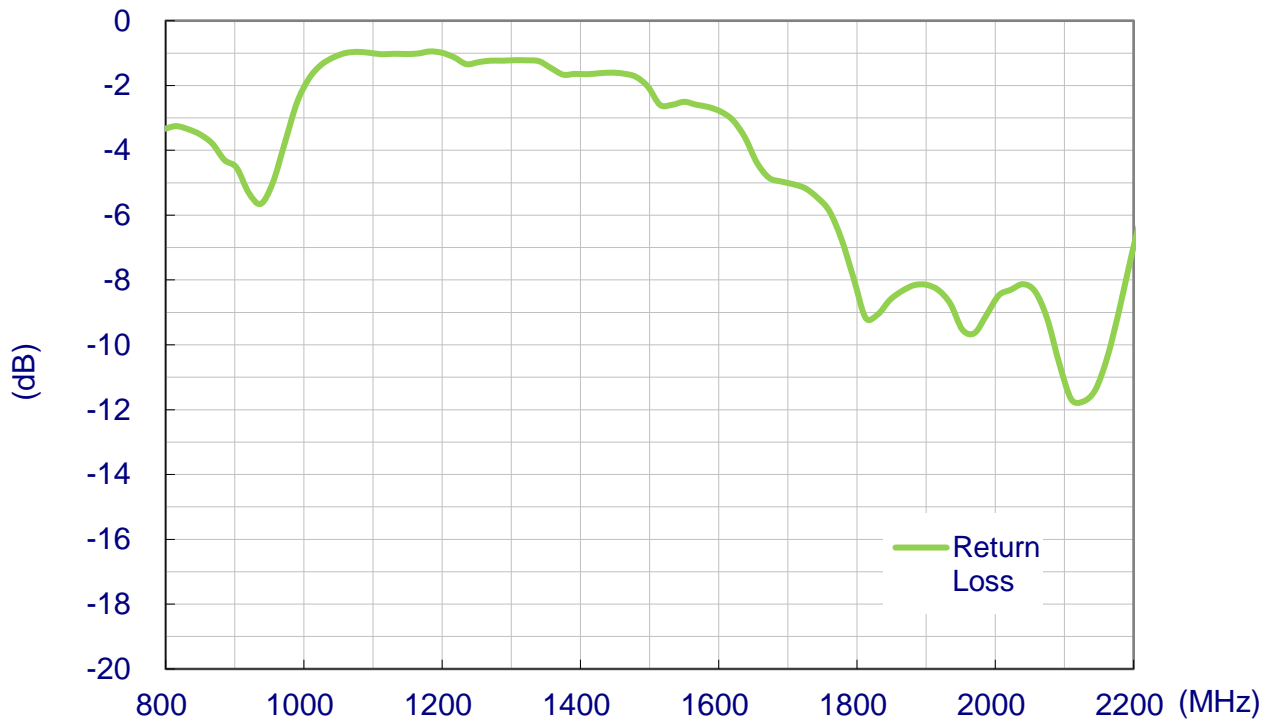

3.2 Efficiency

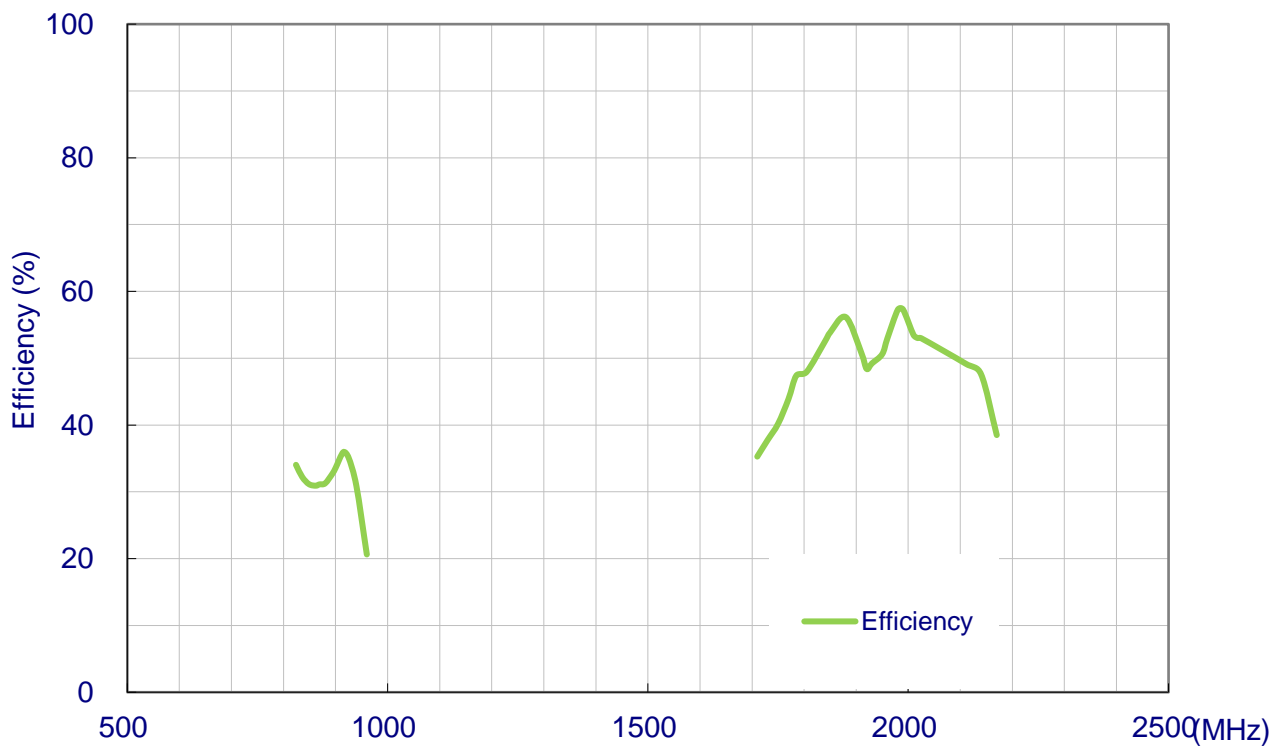

3.3 Average Gain

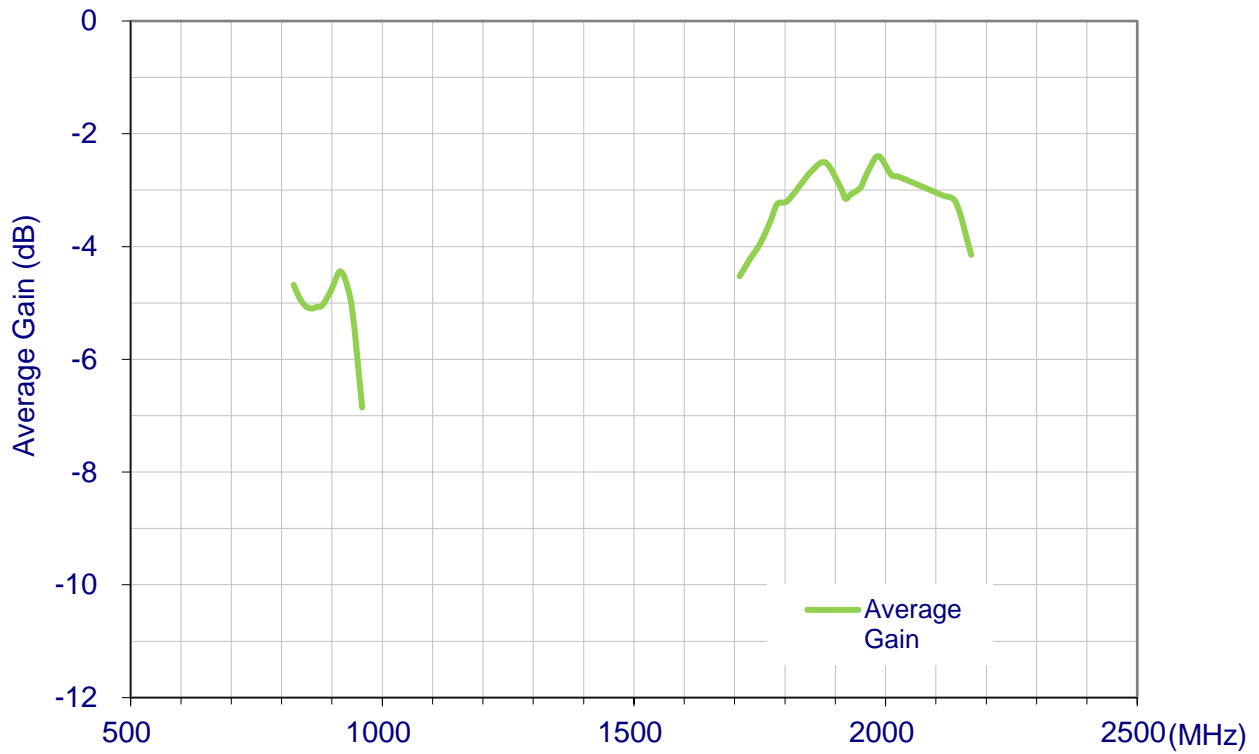

3.4 Peak Gain

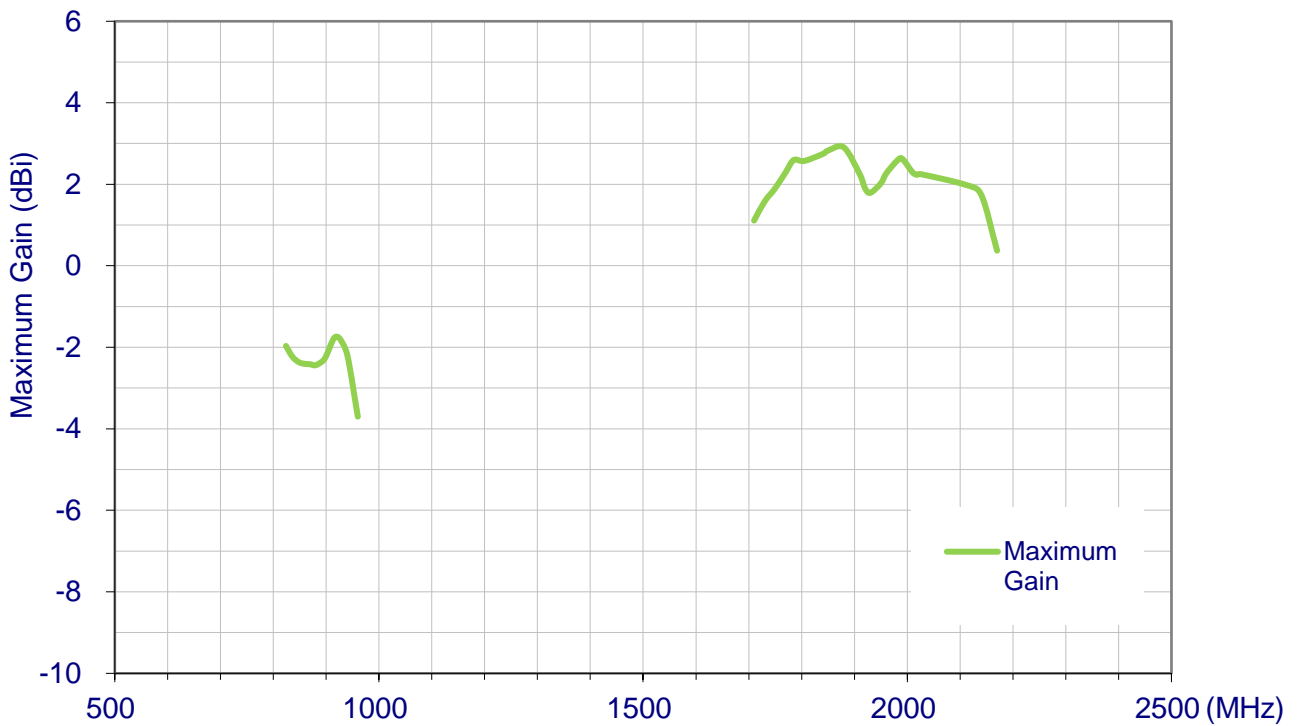

4. Radiation Patterns

4.1 Test Setup on Evaluation Board

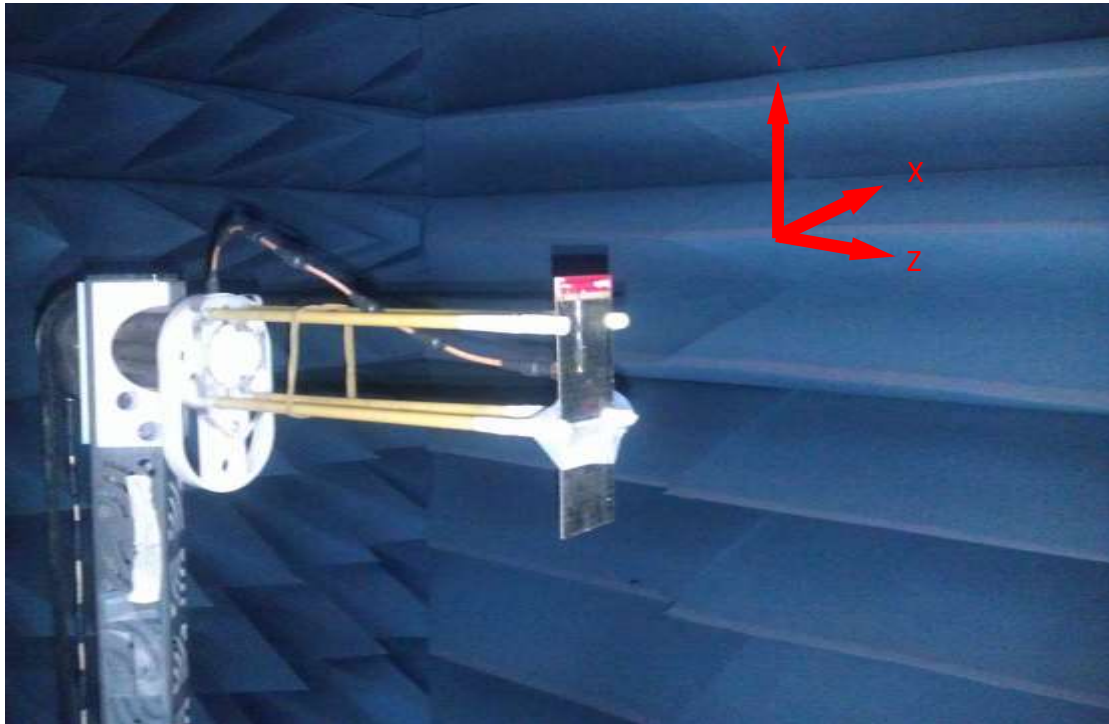

4.2 2D Radiation Patterns

824-960MHz

XY Plane

XZ Plane

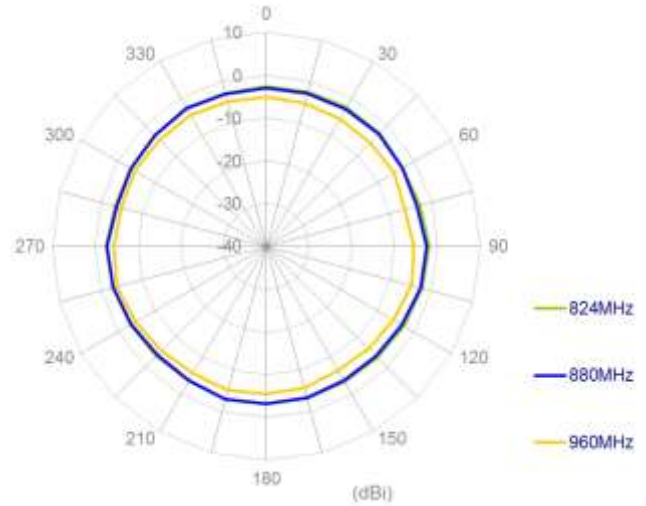
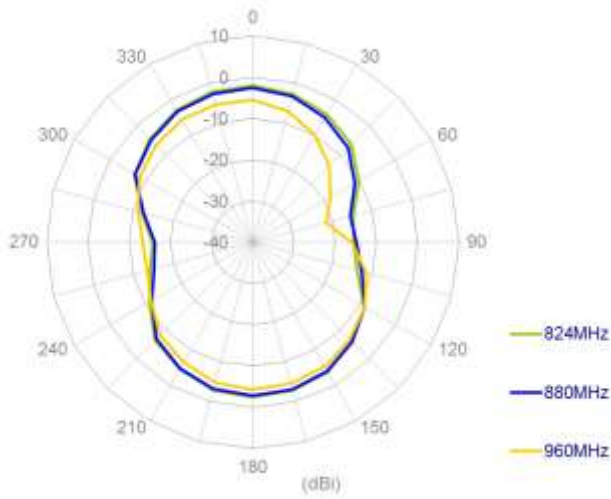

1710-2170MHz

XY Plane

XZ Plane

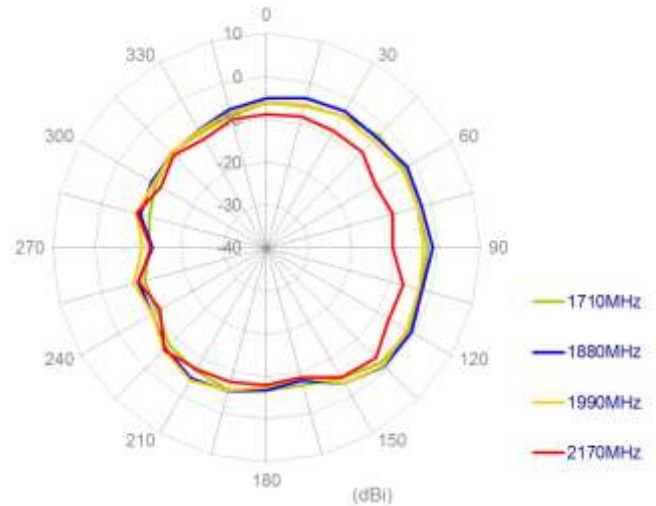
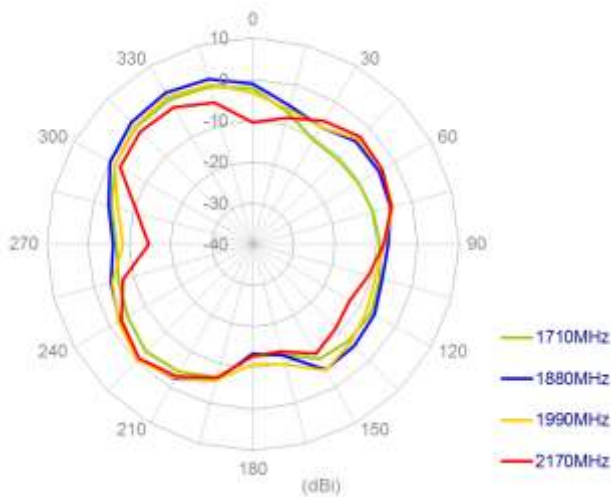

5. Mechanical Drawing (Units: mm)

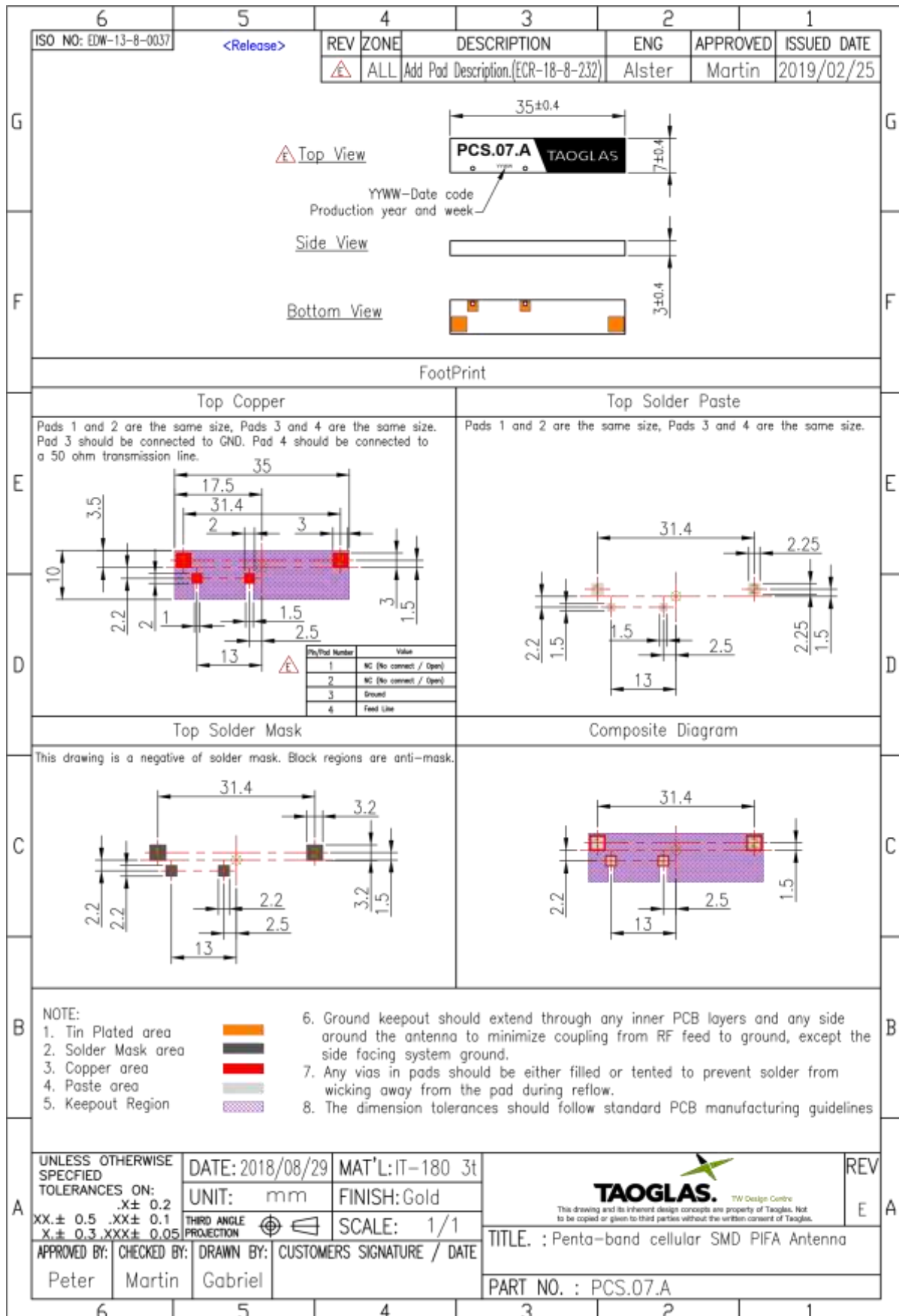

6. Evaluation Board Drawing (Units: mm)

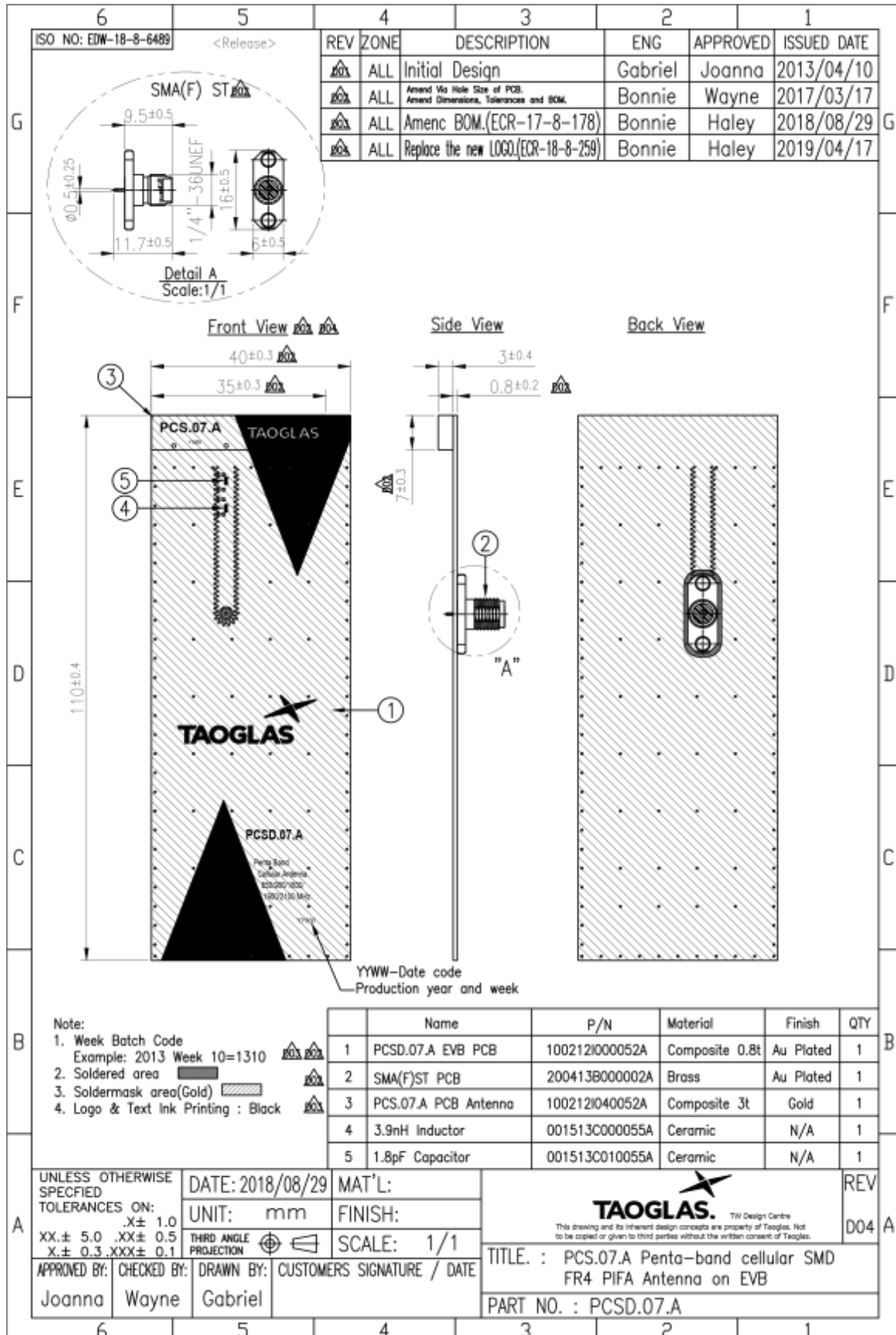

7. Footprint

Footprint
0.8t PCB

Top View

Bottom View

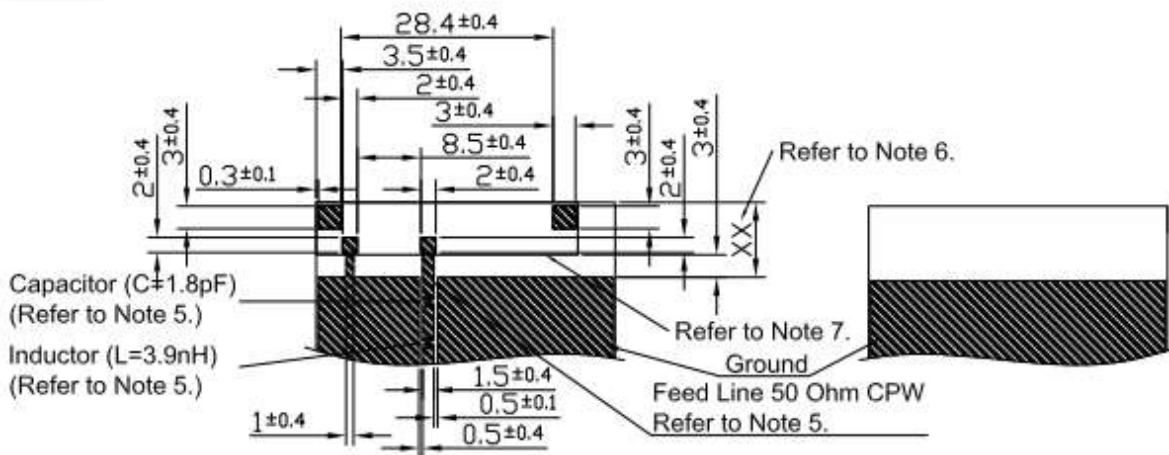

Notes

1. Tin Plated

2. Silkscreen (Black)

3. Soldermask (Gold)

4. Copper



5. Matching circuit - value changes according to ground and layout.

6. Antenna outline for placement reference.

7. Keep out area.

8. Matching Circuit

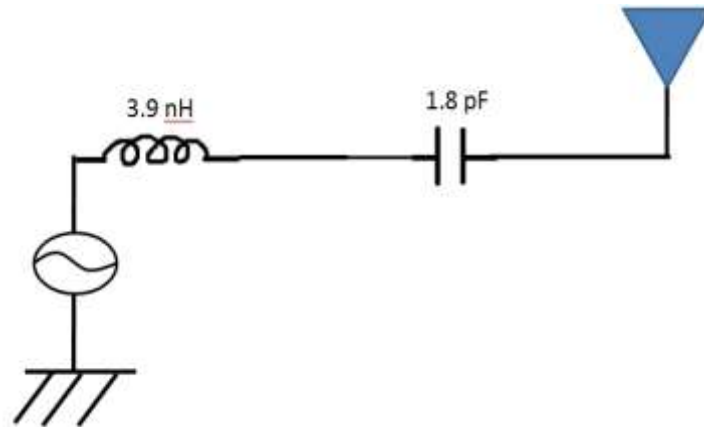

9. Solder Reflow Recommendations

The PCS.07.A can be assembled by following the recommended soldering temperatures are as follows:

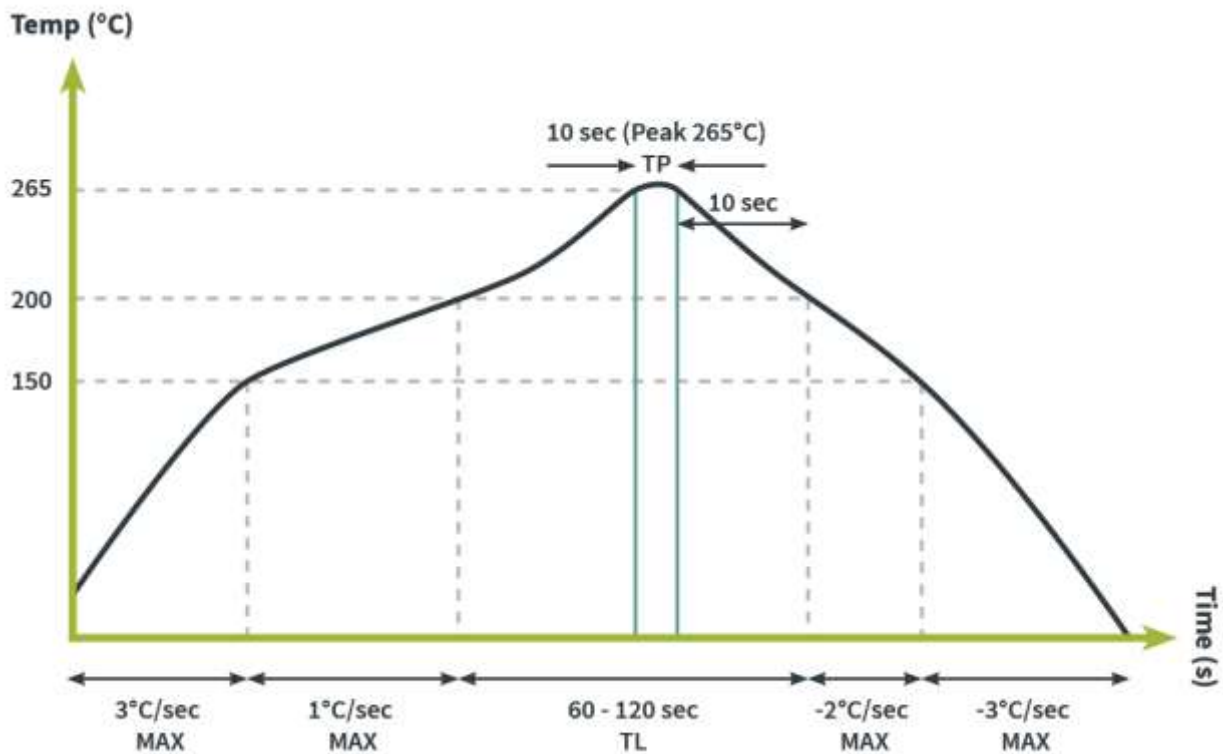

*Temperatures listed within a tolerance of +/- 10° C

The PCS.07.A is not limited to the number of passes through the reflow process. Smaller components are typically mounted on the first pass, however, we do advise mounting the PCS.07.A when placing larger components on the board during subsequent reflows.

1000 pcs PCS.07.A reel
 Dimensions - 330*330*60mm
 Weight -2110g

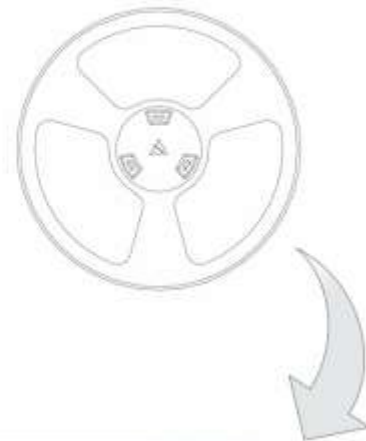

1000 pcs PCS.07.A / 1 Reel in small box
 Dimensions - 337*337*87mm
 Weight -2.39Kg

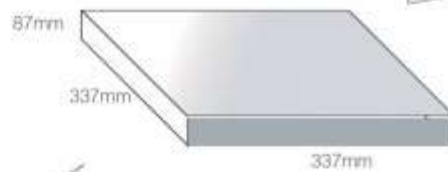

4 reels, 4000 pcs in one carton
 Carton Dimensions - 370*360*370mm
 Weight -10.44Kg

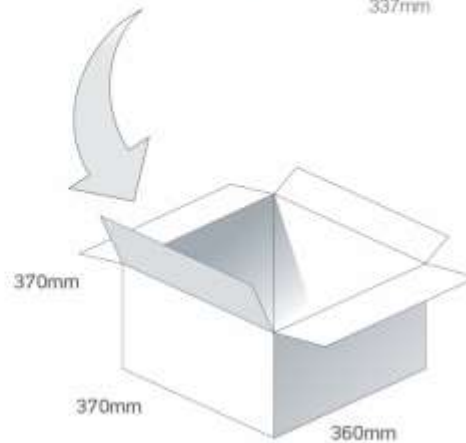

Pallet Dimensions 1200*1000*1310mm
 18 Cartons per Pallet
 6 Cartons per layer
 4 Layers

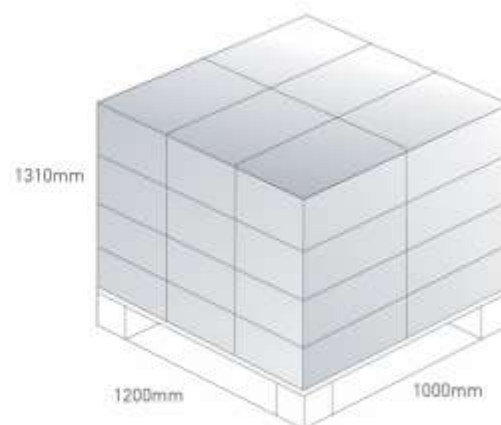

11. Application Note

Investigations of PCS.07.A antenna performance on different lengths of ground plane were conducted, the results are shown below.

11.1 Return Loss

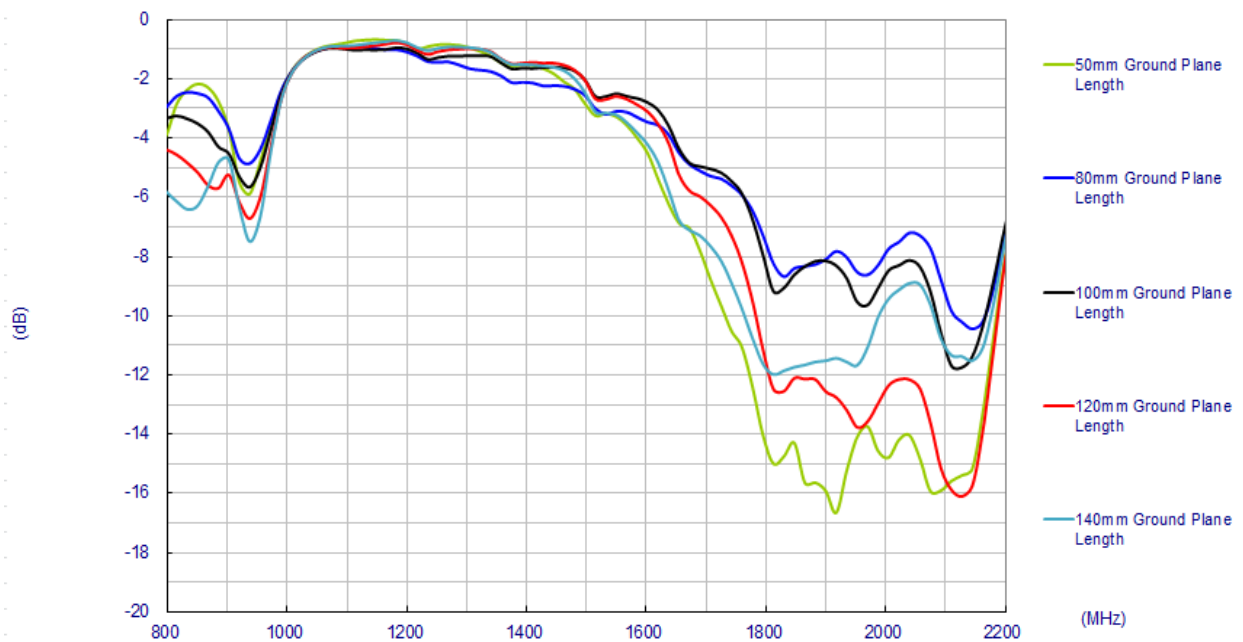

11.2 Efficiency

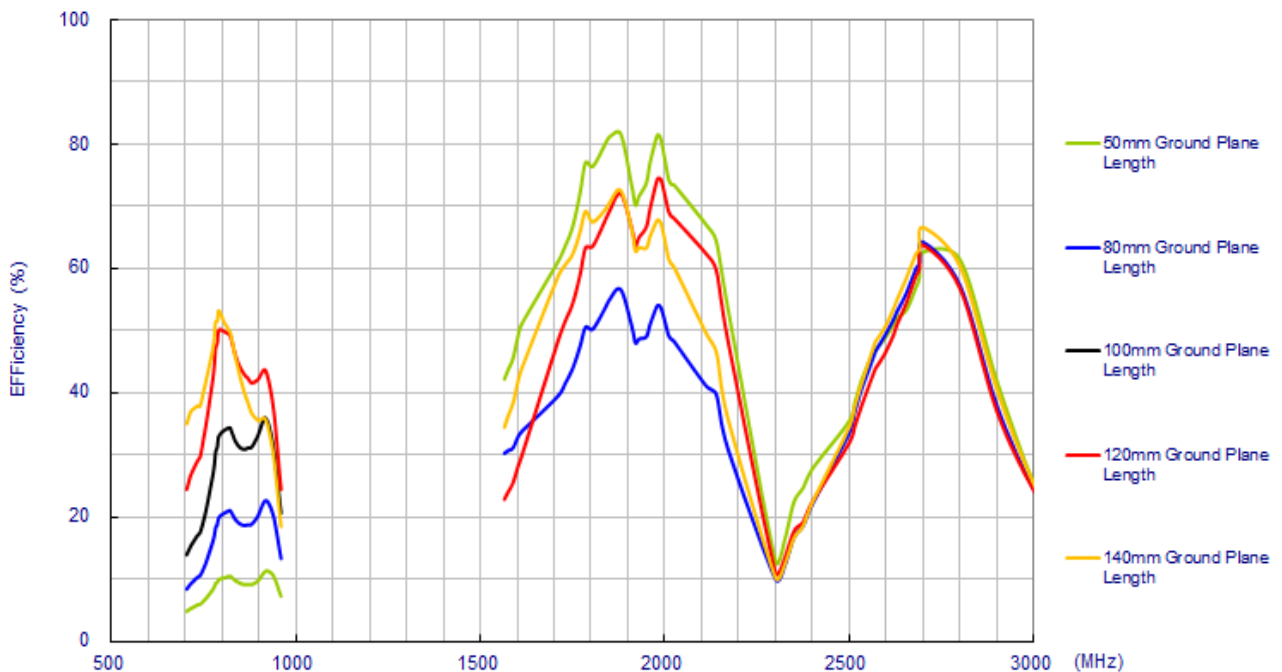

11.3 Peak Gain

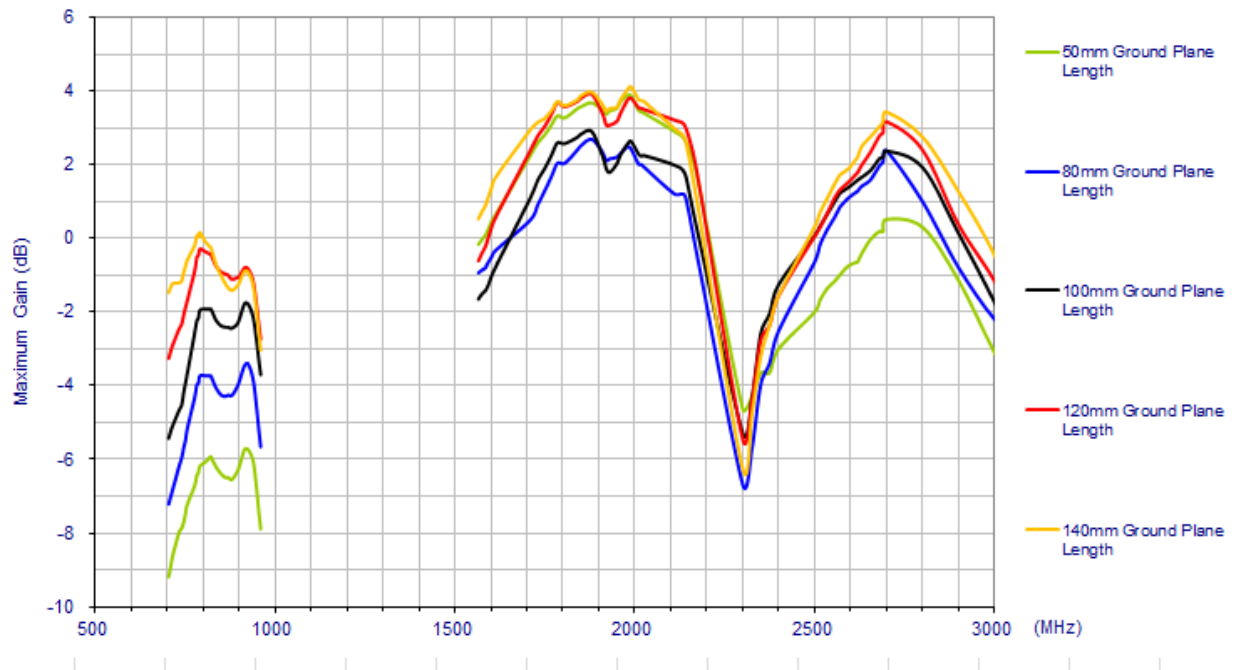

11.4 Average Gain

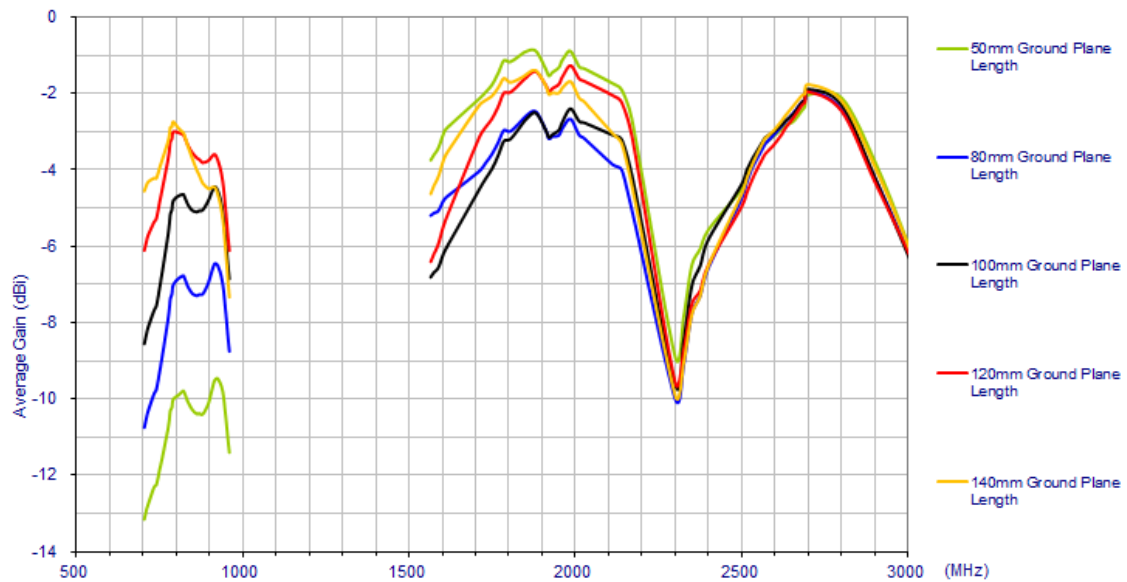

Changelog for the datasheet

SPE-13-8-042 – PCS.07.A

Revision: F (Current Version)

Date:	2021-09-09
Changes:	Solder Reflow Recommendations Amended.
Changes Made by:	Gary West

Previous Revisions

Revision: E

Date:	2021-09-09
Changes:	Added MSL rating, updated font.
Changes Made by:	Erik Landi

Revision: D

Date:	2020-12-01
Changes:	Updated Format and Drawing
Changes Made by:	Jack Conroy

Revision: C

Date:	2018-10-23
Changes:	Updated Drawing
Changes Made by:	David Connolly

Revision: B

Date:	2013-08-11
Changes:	Drawing Updated
Changes Made by:	Aine Doyle

Revision: A (Original First Release)

Date:	2013-04-11
Notes:	
Author:	Wayne Yang



TAOGLAS®

www.taoglas.com

