

DC Film Capacitors MKT Radial Lacquered Type

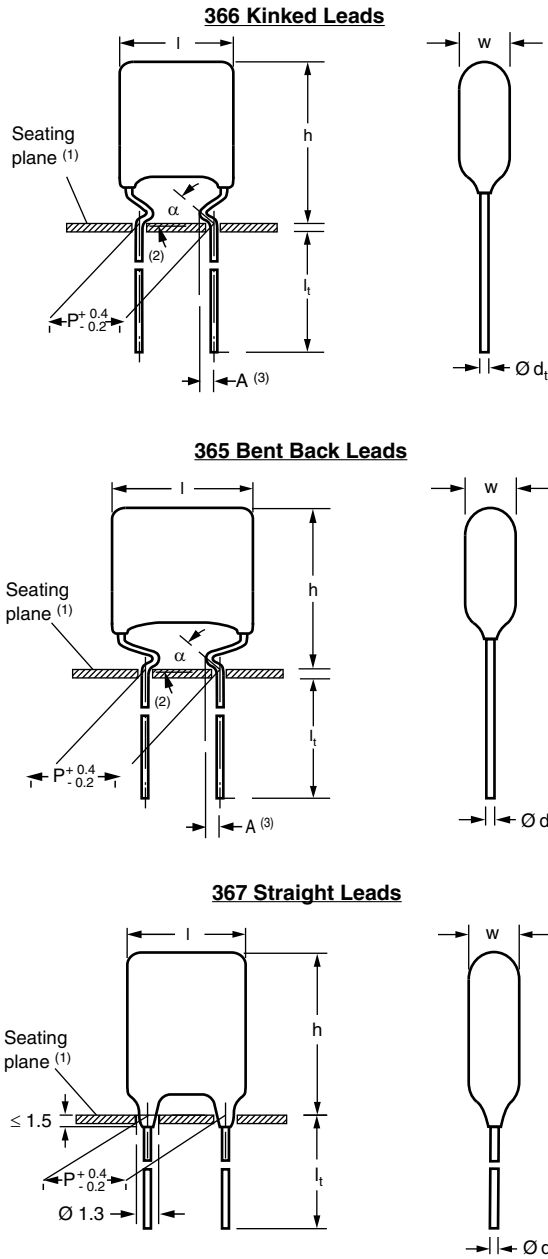

Notes

- (1) Hole \varnothing 1.0 for $d_t = 0.5$ mm
- (2) $0 \leq \alpha < 50^\circ$
- (3) $A = 1.7$ mm \pm 0.3 mm

CONSTRUCTION

Mono construction

Note

- **MKT365 End of Life July-2022**

FEATURES

- Available taped and loose in box
- Material categorization: for definitions of compliance please see www.vishay.com/doc?99912



APPLICATIONS

Blocking and coupling, bypass and energy reservoir.

REFERENCE STANDARDS

IEC 60384-2

MARKING

C-value; rated voltage; tolerance

DIELECTRIC

Polyester film

ELECTRODES

Metallized

RATED (DC) VOLTAGE

63 V_{DC}, 100 V_{DC}, 250 V_{DC}, 400 V_{DC}

RATED (AC) VOLTAGE

40 V_{AC}, 63 V_{AC}, 160 V_{AC}, 220 V_{AC}

COATING ENCAPSULATION

Flame retardant epoxy material (UL-class 94 V-0)

CLIMATIC TESTING CLASS ACCORDING TO IEC 60068-1

55/105/56

RATED TEMPERATURE

85 °C

CAPACITANCE RANGE (E12 SERIES)

365: 0.01 μ F to 1.0 μ F

366: 0.0033 μ F to 1.0 μ F

367: 0.0033 μ F to 1.0 μ F

CAPACITANCE TOLERANCE

\pm 10 %, \pm 5 %

LEADS

Tinned wire

MAXIMUM APPLICATION TEMPERATURE

105 °C

DETAIL SPECIFICATION

For more detailed data and test requirements contact: dc-film@vishay.com



COMPOSITION OF CATALOG NUMBER: 365

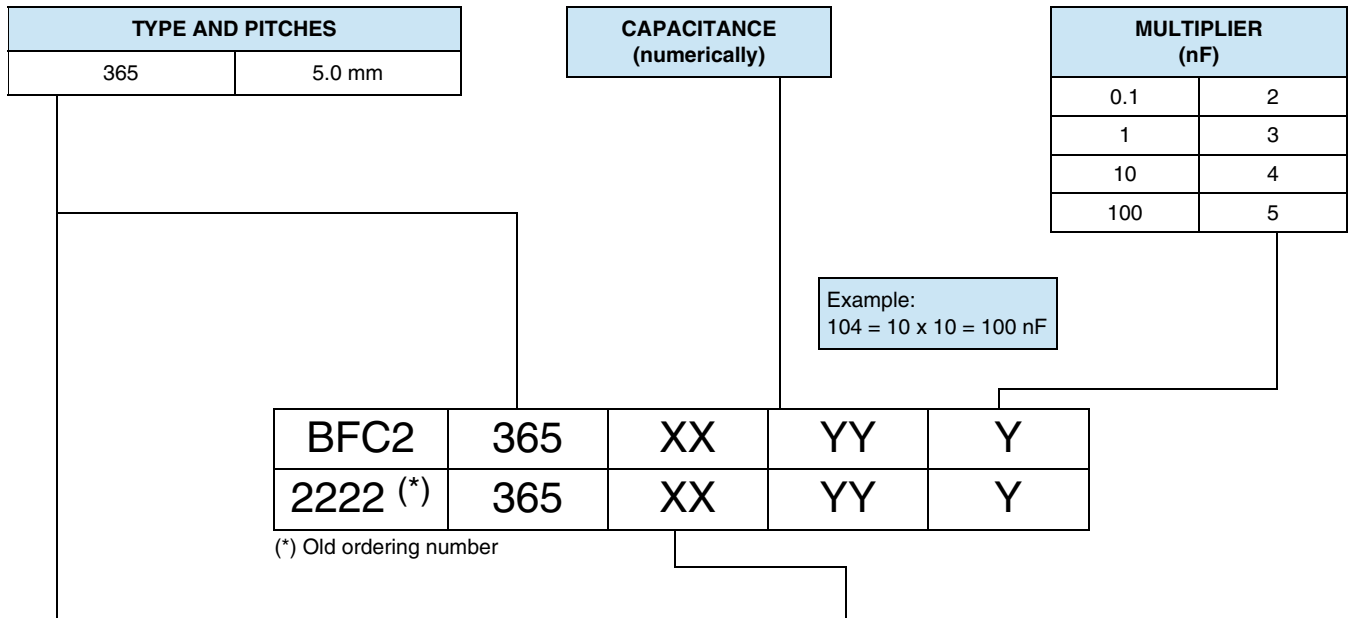

TYPE	PACKAGING	LEAD CONFIGURATION	PREFERRED TYPES				
			C-TOL.	63 V	100 V	250 V	400 V
365	Ammopack	Bent back leads; H = 16.0 mm; P ₀ = 12.7 mm	± 10 %	15	25	45	55
			± 5 %	16	26	46	56
			Dimensions of these code numbers stay between brackets				
	Taped on reel ⁽¹⁾	Bent back leads; H = 16.0 mm; P ₀ = 12.7 mm	± 10 %	11	21	41	51
			± 5 %	12	22	42	52
			Dimensions of these code numbers stay between brackets				

Note

- For detailed tape specifications refer to packaging information: www.vishay.com/doc?28139

SPECIFIC REFERENCE DATA: 365

DESCRIPTION	VALUE			
	at 1 kHz	at 10 kHz	at 100 kHz	
Tangent of loss angle:				
C ≤ 0.47 μF	≤ 75 x 10 ⁻⁴	≤ 130 x 10 ⁻⁴	≤ 225 x 10 ⁻⁴	
C > 0.47 μF	≤ 75 x 10 ⁻⁴	≤ 130 x 10 ⁻⁴	-	
Rated voltage pulse slope (dU/dt) _R at	63 V _{DC}	100 V _{DC}	250 V _{DC}	400 V _{DC}
	110 V/μs	110 V/μs	130 V/μs	170 V/μs
R between leads, for C ≤ 0.33 μF at 10 V; 1 min at 100 V; 1 min	> 15 000 MΩ	> 15 000 MΩ	> 30 000 MΩ	> 30 000 MΩ
RC between leads, for C > 0.33 μF at 10 V; 1 min	> 5000 s		-	
R between interconnecting leads and casing, 100 V; 1 min	> 30 000 MΩ			
Withstanding (DC) voltage (cut off current 10 mA) ⁽¹⁾ ; rise time ≤ 1000 V/s	100 V; 1 min	160 V; 1 min	400 V; 1 min	640 V; 1 min
Maximum application temperature	105 °C			

Note

- ⁽¹⁾ See "Voltage Proof Test for Metallized Film Capacitors": www.vishay.com/doc?28169

Note

- MKT365 End of Life July-2022**



$U_{RDC} = 63\text{ V}$; $U_{RAC} = 40\text{ V}$ (bent back leads)

C (μF)	DIMENSIONS $w_{max.} \times h_{max.} \times l_{max.}$ (mm)	MASS (g) ⁽¹⁾	CATALOG NUMBER BFC2 365 XXYYY AND PACKAGING				C-VALUE ..YYY
			AMMOPACK		REEL		
			H = 16.0 mm		H = 16.0 mm		
			C-TOL. = $\pm 10\%$	C-TOL. = $\pm 5\%$	C-TOL. = $\pm 10\%$	C-TOL. = $\pm 5\%$	
			XX (SPQ)	XX (SPQ)	XX (SPQ)	XX (SPQ)	
PITCH = 5.0 mm + 0.4 mm / - 0.2 mm; $d_t = 0.60\text{ mm} \pm 0.06\text{ mm}$							
0.12	4.0 x 13.5 x 10.0	0.35	15...	16...	11...	12...	124
0.15			(1500)	(1500)	(1500)	(1500)	154
0.18							184
0.22							224
0.27	4.5 x 14.0 x 10.0	0.39	15... (1000)	16... (1000)	11... (1000)	12... (1000)	274
0.33	5.0 x 14.5 x 10.0	0.45	15... (1500)	16... (1000)	11... (1000)	12... (1000)	334
0.39							394
0.47	5.5 x 15.0 x 10.0	0.55					474
0.56							564
0.68			15... (1000)	16... (1000)	11... (1000)	12... (1000)	684
0.82							824
1.0							105

Notes

- SPQ = Standard Packing Quantity
- ⁽¹⁾ Net weight for short lead products only

$U_{RDC} = 100\text{ V}$; $U_{RAC} = 63\text{ V}$ (bent back leads)

C (μF)	DIMENSIONS $w_{max.} \times h_{max.} \times l_{max.}$ (mm)	MASS (g) ⁽¹⁾	CATALOG NUMBER BFC2 365 XXYYY AND PACKAGING				C-VALUE ..YYY
			AMMOPACK		REEL		
			H = 16.0 mm		H = 16.0 mm		
			C-TOL. = $\pm 10\%$	C-TOL. = $\pm 5\%$	C-TOL. = $\pm 10\%$	C-TOL. = $\pm 5\%$	
			XX (SPQ)	XX (SPQ)	XX (SPQ)	XX (SPQ)	
Pitch = 5.0 mm + 0.4 mm / - 0.2 mm; $d_t = 0.60\text{ mm} \pm 0.06\text{ mm}$							
0.039	4.0 x 13.5 x 10.0	0.35					393
0.047							473
0.056			25... (1500)	26... (1500)	21... (1500)	22... (1500)	563
0.068							683
0.082							823
0.10							104
0.12	4.5 x 14.0 x 10.5	0.40	25... (1000)	26... (1000)	21... (1000)	22... (1000)	124
0.15	5.0 x 14.5 x 10.5	0.45	25... (1000)	26... (1000)	21... (1000)	22... (1000)	154
0.18							184
0.22	5.5 x 15.0 x 10.5	0.57	25... (1000)	26... (1000)	21... (1000)	22... (1000)	224
0.27	6.0 x 15.5 x 10.5	0.60					274
0.33			25... (1000)	26... (1000)	21... (1000)	22... (1000)	334
0.39							394
0.47							474

Notes

- SPQ = Standard Packing Quantity
- ⁽¹⁾ Net weight for short lead products only

Note

- **MKT365 End of Life July-2022**



$U_{RDC} = 250\text{ V}$; $U_{RAC} = 160\text{ V}$ (bent back leads)

C (μF)	DIMENSIONS $w_{\text{max.}} \times h_{\text{max.}} \times l_{\text{max.}}$ (mm)	MASS (g) ⁽¹⁾	CATALOG NUMBER BFC2 365 XYYYY AND PACKAGING				C-VALUE ..YYY
			AMMOPACK		REEL		
			H = 16.0 mm		H = 16.0 mm		
			C-TOL. = $\pm 10\%$	C-TOL. = $\pm 5\%$	C-TOL. = $\pm 10\%$	C-TOL. = $\pm 5\%$	
			XX (SPQ)	XX (SPQ)	XX (SPQ)	XX (SPQ)	
Pitch = 5.0 mm + 0.4 mm / - 0.2 mm; $d_t = 0.60\text{ mm} \pm 0.06\text{ mm}$							
0.018	4.0 x 13.5 x 10.0	0.35					183
0.022							223
0.027							273
0.033			45... (1500)	46... (1500)	41... (1500)	42... (1500)	333
0.039							393
0.047							473
0.056							563
0.068	4.5 x 14.0 x 10.0	0.39	45... (1250)	46... (1250)	41... (1000)	42... (1000)	683
0.082	4.5 x 13.0 x 10.0	0.38	45... (1250)	46... (1250)	41... (1250)	42... (1250)	823
0.10	5.0 x 13.5 x 10.0	0.40	45... (1000)	46... (1000)	41... (1250)	42... (1250)	104
0.12	5.5 x 14.0 x 10.0	0.50	45... (1000)	46... (1000)	41... (1000)	42... (1000)	124
0.15	5.5 x 15.5 x 10.0	0.58	45... (1000)	46... (1000)	41... (1000)	42... (1000)	154

Notes

- SPQ = Standard Packing Quantity
- ⁽¹⁾ Net weight for short lead products only

$U_{RDC} = 400\text{ V}$; $U_{RAC} = 220\text{ V}$ (bent back leads)

C (μF)	DIMENSIONS $w_{\text{max.}} \times h_{\text{max.}} \times l_{\text{max.}}$ (mm)	MASS (g) ⁽¹⁾	CATALOG NUMBER BFC2 365 XYYYY AND PACKAGING				C-VALUE ..YYY
			AMMOPACK		REEL		
			H = 16.0 mm		H = 16.0 mm		
			C-TOL. = $\pm 10\%$	C-TOL. = $\pm 5\%$	C-TOL. = $\pm 10\%$	C-TOL. = $\pm 5\%$	
			XX (SPQ)	XX (SPQ)	XX (SPQ)	XX (SPQ)	
Pitch = 5.0 mm + 0.4 mm / - 0.2 mm; $d_t = 0.60\text{ mm} \pm 0.06\text{ mm}$							
0.0033	4.0 x 13.5 x 10.0	0.35					332
0.0039							392
0.0047							472
0.0056							562
0.0068			55... (1500)	56... (1500)	51... (1500)	52... (1500)	682
0.0082							822
0.010							103
0.012							123
0.015							153
0.018			4.5 x 13.0 x 10.0	0.38	55... (1250)	56... (1250)	51... (1250)
0.022	5.0 x 13.5 x 10.0	0.40	55... (1000)	56... (1000)	51... (1250)	52... (1250)	223
0.027	4.0 x 12.5 x 10.0	0.35	55... (1500)	56... (1500)	51... (1500)	52... (1500)	273
0.033	4.5 x 13.0 x 10.0	0.38	55... (1200)	56... (1250)	51... (1250)	52... (1250)	333
0.039	5.0 x 13.5 x 10.0	0.40	55... (1000)	56... (1000)	51... (1250)	52... (1250)	393
0.047							473
0.056	5.5 x 14.0 x 10.0	0.50	55... (1000)	56... (1000)	51... (1000)	52... (1000)	563

Notes

- SPQ = Standard Packing Quantity
- ⁽¹⁾ Net weight for short lead products only

Note

- **MKT365 End of Life July-2022**



COMPOSITION OF CATALOG NUMBER: 366

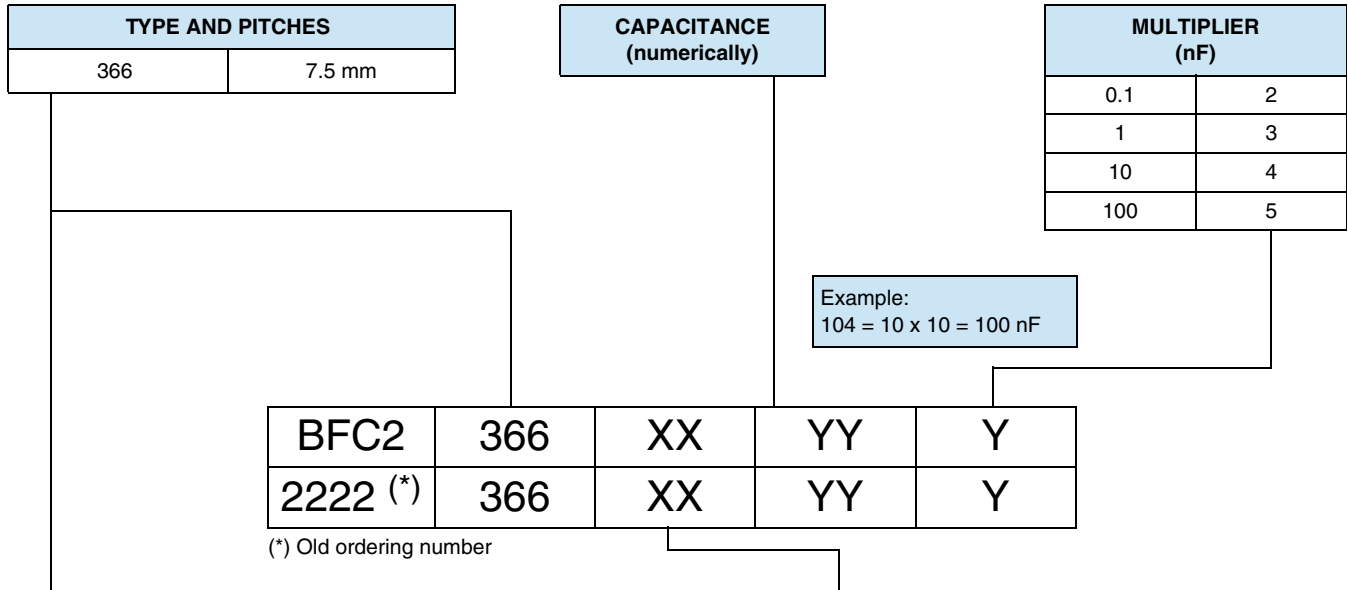

TYPE	PACKAGING	LEAD CONFIGURATION	PREFERRED TYPES				
			C-TOL.	63 V	100 V	250 V	400 V
Pitch = 7.5 mm							
366	Loose in box	Kinked; Lead length 4.0 + 1.0/- 0.5 mm	± 10 %	15	25	45	55
			± 5 %	16	26	46	56
		Kinked; Lead length 17.0 ± 4.0 mm	± 10 %	11	21	41	51
			± 5 %	12	22	42	52
	Ammopack (1)	Kinked; H = 16.0 mm; P ₀ = 12.7 mm	± 10 %	13	23	43	53
			± 5 %	17	27	47	57

Note

- For detailed tape specifications refer to packaging information: www.vishay.com/doc?28139

SPECIFIC REFERENCE DATA: 366

DESCRIPTION	VALUE			
	at 1 kHz	at 10 kHz	at 100 kHz	
Tangent of loss angle:				
C ≤ 0.47 μF	≤ 75 x 10 ⁻⁴	≤ 130 x 10 ⁻⁴	≤ 225 x 10 ⁻⁴	
C > 0.47 μF	≤ 75 x 10 ⁻⁴	≤ 130 x 10 ⁻⁴	-	
Rated voltage pulse slope (dU/dt) _R at	63 V _{DC}	100 V _{DC}	250 V _{DC}	400 V _{DC}
	110 V/μs	110 V/μs	130 V/μs	170 V/μs
R between leads, for C ≤ 0.33 μF at 10 V; 1 min at 100 V; 1 min	> 15 000 MΩ	> 15 000 MΩ	> 30 000 MΩ	> 30 000 MΩ
RC between leads, for C > 0.33 μF at 10 V; 1 min	> 5000 s		-	
R between interconnecting leads and casing, 100 V; 1 min	> 30 000 MΩ			
Withstanding (DC) voltage (cut off current 10 mA) (1); rise time ≤ 1000 V/s	100 V; 1 min	160 V; 1 min	400 V; 1 min	640 V; 1 min
Maximum application temperature	105 °C			

Note

- (1) See "Voltage Proof Test for Metallized Film Capacitors": www.vishay.com/doc?28169



U_{RDC} = 63 V; U_{RAC} = 40 V

C (μF)	DIMENSIONS w _{max.} x h _{max.} x l _{max.} (mm)	MASS (g) ⁽¹⁾	CATALOG NUMBER BFC2 366 XXYYY AND PACKAGING						C-VALUE ..YYY
			LOOSE IN BOX				AMMOPACK		
			l _t = 4.0 mm + 1.0 mm / - 0.5 mm		l _t = 17.0 mm ± 4.0 mm		H = 16.0 mm		
			C-TOL. = ± 10 %	C-TOL. = ± 5 %	C-TOL. = ± 10 %	C-TOL. = ± 5 %	C-TOL. = ± 10 %	C-TOL. = ± 5 %	
XX (SPQ)		XX (SPQ)		XX (SPQ)		XX (SPQ)			
Pitch = 7.5 mm + 0.4 mm / - 0.2 mm; d _t = 0.60 mm ± 0.06 mm									
0.12 0.15 0.18 0.22	4.0 x 12.0 x 10.0	0.30	15... (1000)	16... (1000)	11... (1000)	12... (1000)	13... (1500)	17... (1500)	124 154 184 224
0.27	4.5 x 13.0 x 10.5	0.38	15... (1000)	16... (1000)	11... (1000)	12... (1000)	13... (1250)	17... (1250)	274
0.33 0.39	5.0 x 13.5 x 10.5	0.43	15... (1000)	16... (1000)	11... (1000)	12... (1000)	13... (1000)	17... (1000)	334 394
0.47	5.5 x 14.0 x 10.5	0.53	15... (1000)	16... (1000)	11... (1000)	12... (1000)	13... (1000)	17... (1000)	474
0.56 0.68 0.82 1.0	5.5 x 14.5 x 10.5	0.54	15... (1000)	16... (1000)	11... (1000)	12... (1000)	13... (1000)	17... (1000)	564 684 824 105

Notes

- SPQ = Standard Packing Quantity
- ⁽¹⁾ Net weight for short lead products only

U_{RDC} = 100 V; U_{RAC} = 63 V

C (μF)	DIMENSIONS w _{max.} x h _{max.} x l _{max.} (mm)	MASS (g) ⁽¹⁾	CATALOG NUMBER BFC2 366 XXYYY AND PACKAGING						C-VALUE ..YYY
			LOOSE IN BOX				AMMOPACK		
			l _t = 4.0 mm + 1.0 mm / - 0.5 mm		l _t = 17.0 mm ± 4.0 mm		H = 16.0 mm		
			C-TOL. = ± 10 %	C-TOL. = ± 5 %	C-TOL. = ± 10 %	C-TOL. = ± 5 %	C-TOL. = ± 10 %	C-TOL. = ± 5 %	
XX (SPQ)		XX (SPQ)		XX (SPQ)		XX (SPQ)			
Pitch = 7.5 mm + 0.4 mm / - 0.2 mm; d _t = 0.60 mm ± 0.06 mm									
0.039 0.047 0.056 0.068 0.082	4.0 x 12.0 x 10.0	0.30	25... (1000)	26... (1000)	21... (1000)	22... (1000)	23... (1500)	27... (1500)	393 473 563 683 823
0.10	4.0 x 13.0 x 10.0	0.26	25... (1000)	26... (1000)	21... (1000)	22... (1000)	23... (1500)	27... (1500)	104
0.12	4.5 x 13.0 x 10.5	0.38	25... (1000)	26... (1000)	21... (1000)	22... (1000)	23... (1250)	27... (1250)	124
0.15	5.0 x 13.0 x 15.0	0.40	25... (1000)	26... (1000)	21... (1000)	22... (1000)	23... (1000)	27... (1000)	154
0.18	5.0 x 13.5 x 10.5	0.43	25... (1000)	26... (1000)	21... (1000)	22... (1000)	23... (1000)	27... (1000)	184
0.22	5.5 x 13.5 x 10.5	0.50	25... (1000)	26... (1000)	21... (1000)	22... (1000)	23... (1000)	27... (1000)	224
0.27	6.0 x 14.5 x 10.5	0.55	25... (1000)	26... (1000)	21... (1000)	22... (1000)	23... (1000)	27... (1000)	274
0.33 0.39 0.47	6.0 x 15.0 x 10.5	0.58	25... (1000)	26... (1000)	21... (1000)	22... (1000)	23... (1000)	27... (1000)	334 394 474

Notes

- SPQ = Standard Packing Quantity
- ⁽¹⁾ Net weight for short lead products only



U_{RDC} = 250 V; U_{RAC} = 160 V

C (µF)	DIMENSIONS w _{max.} x h _{max.} x l _{max.} (mm)	MASS (g) ⁽¹⁾	CATALOG NUMBER BFC2 366 XXYYY AND PACKAGING						C-VALUE ..YYY
			LOOSE IN BOX				AMMOPACK		
			l _t = 4.0 mm + 1.0 mm / - 0.5 mm		l _t = 17.0 mm ± 4.0 mm		H = 16.0 mm		
			C-TOL. = ± 10 %	C-TOL. = ± 5 %	C-TOL. = ± 10 %	C-TOL. = ± 5 %	C-TOL. = ± 10 %	C-TOL. = ± 5 %	
			XX (SPQ)	XX (SPQ)	XX (SPQ)	XX (SPQ)	XX (SPQ)	XX (SPQ)	
Pitch = 7.5 mm + 0.4 mm / - 0.2 mm; d _t = 0.60 mm ± 0.06 mm									
0.018 0.022 0.027 0.033 0.039 0.047	4.0 x 13.0 x 10.0	0.26	45... (1000)	46... (1000)	41... (1000)	42... (1000)	43... (1500)	47... (1500)	183 223 273 333 393 473
0.056	4.0 x 14.0 x 10.0	0.35	45... (1000)	46... (1000)	41... (1000)	42... (1000)	43... (1500)	47... (1500)	563
0.068	4.5 x 14.0 x 10.0	0.39	45... (1000)	46... (1000)	41... (1000)	42... (1000)	43... (1250)	47... (1250)	683
0.082	4.5 x 13.0 x 10.0	0.38	45... (1000)	46... (1000)	41... (1000)	42... (1000)	43... (1250)	47... (1250)	823
0.10	5.0 x 13.5 x 10.0	0.40	45... (1000)	46... (1000)	41... (1000)	42... (1000)	43... (1000)	47... (1000)	104
0.12	5.5 x 14.0 x 10.0	0.50	45... (1000)	46... (1000)	41... (1000)	42... (1000)	43... (1000)	47... (1000)	124
0.15	5.5 x 15.5 x 10.0	0.58	45... (1000)	46... (1000)	41... (1000)	42... (1000)	43... (1000)	47... (1000)	154

Notes

- SPQ = Standard Packing Quantity
- ⁽¹⁾ Net weight for short lead products only

U_{RDC} = 400 V; U_{RAC} = 220 V

C (µF)	DIMENSIONS w _{max.} x h _{max.} x l _{max.} (mm)	MASS (g) ⁽¹⁾	CATALOG NUMBER BFC2 366 XXYYY AND PACKAGING						C-VALUE ..YYY
			LOOSE IN BOX				AMMOPACK		
			l _t = 4.0 mm + 1.0 mm / - 0.5 mm		l _t = 17.0 mm ± 4.0 mm		H = 16.0 mm		
			C-TOL. = ± 10 %	C-TOL. = ± 5 %	C-TOL. = ± 10 %	C-TOL. = ± 5 %	C-TOL. = ± 10 %	C-TOL. = ± 5 %	
			XX (SPQ)	XX (SPQ)	XX (SPQ)	XX (SPQ)	XX (SPQ)	XX (SPQ)	
Pitch = 7.5 mm + 0.4 mm / - 0.2 mm; d _t = 0.60 mm ± 0.06 mm									
0.0033 0.0039 0.0047	4.0 x 12.0 x 10.0	0.30	55... (1000)	56... (1000)	51... (1000)	52... (1000)	53... (1500)	57... (1500)	332 392 472
0.0056 0.0068 0.0082 0.010 0.012 0.015	4.0 x 13.0 x 10.0	0.26	55... (1000)	56... (1000)	51... (1000)	52... (1000)	53... (1500)	57... (1500)	562 682 822 103 123 153
0.018	4.0 x 13.5 x 10.0	0.35	55... (1000)	56... (1000)	51... (1000)	52... (1000)	53... (1250)	57... (1250)	183
0.022	5.0 x 14.0 x 10.0	0.45	55... (1000)	56... (1000)	51... (1000)	52... (1000)	53... (1000)	57... (1000)	223
0.027	4.0 x 12.5 x 10.0	0.35	55... (1000)	56... (1000)	51... (1000)	52... (1000)	53... (1500)	57... (1500)	273
0.033	4.5 x 13.0 x 10.0	0.38	55... (1000)	56... (1000)	51... (1000)	52... (1000)	53... (1250)	57... (1250)	333
0.039 0.047	5.0 x 13.5 x 10.0	0.40	55... (1000)	56... (1000)	51... (1000)	52... (1000)	53... (1000)	57... (1000)	393 473
0.056	5.5 x 14.0 x 10.0	0.50	55... (1000)	56... (1000)	51... (1000)	52... (1000)	53... (1000)	57... (1000)	563

Notes

- SPQ = Standard Packing Quantity
- ⁽¹⁾ Net weight for short lead products only



COMPOSITION OF CATALOG NUMBER: 367

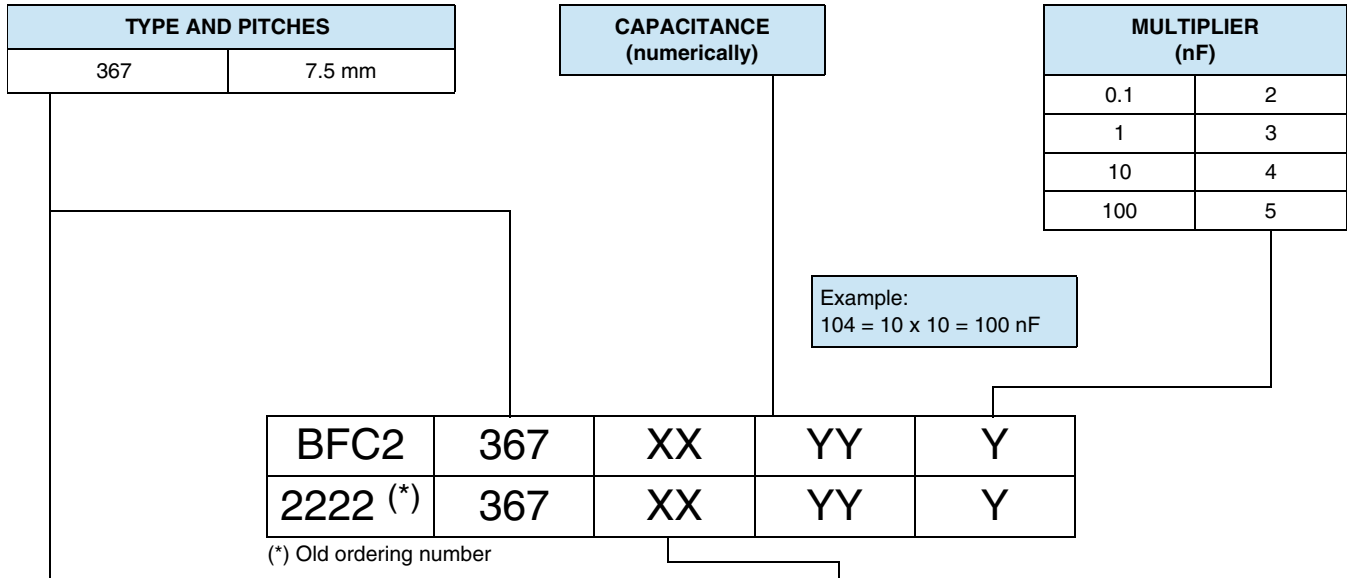

TYPE	PACKAGING	LEAD CONFIGURATION	PREFERRED TYPES				
			C-TOL.	63 V	100 V	250 V	400 V
Pitch = 7.5 mm							
367	Loose in box	Straight; Lead length 4.0 + 1.0/- 0.5 mm	± 10 %	15	25	45	55
			± 5 %	16	26	46	56
		Straight; Lead length 22.0 ± 4.0 mm	± 10 %	11	21	41	51
			± 5 %	12	22	42	52
	Ammopack (1)	Straight; H = 18.5 mm; P ₀ = 12.7 mm	± 10 %	13	23	43	53
			± 5 %	17	27	47	57

Note

- For detailed tape specifications refer to packaging information: www.vishay.com/doc?28139

SPECIFIC REFERENCE DATA: 367

DESCRIPTION	VALUE			
	at 1 kHz	at 10 kHz	at 100 kHz	
Tangent of loss angle:				
C ≤ 0.47 μF	≤ 75 x 10 ⁻⁴	≤ 130 x 10 ⁻⁴	≤ 225 x 10 ⁻⁴	
C > 0.47 μF	≤ 75 x 10 ⁻⁴	≤ 130 x 10 ⁻⁴	-	
Rated voltage pulse slope (dU/dt) _R at	63 V _{DC}	100 V _{DC}	250 V _{DC}	400 V _{DC}
	110 V/μs	110 V/μs	130 V/μs	170 V/μs
R between leads, for C ≤ 0.33 μF at 10 V; 1 min at 100 V; 1 min	> 15 000 MΩ	> 15 000 MΩ	> 30 000 MΩ	> 30 000 MΩ
RC between leads, for C > 0.33 μF at 10 V; 1 min	> 5000 s		-	
R between interconnecting leads and casing, 100 V; 1 min	> 30 000 MΩ			
Withstanding (DC) voltage (cut off current 10 mA) (1); rise time ≤ 1000 V/s	100 V; 1 min	160 V; 1 min	400 V; 1 min	640 V; 1 min
Maximum application temperature	105 °C			

Note

- (1) See "Voltage Proof Test for Metallized Film Capacitors": www.vishay.com/doc?28169



$U_{RDC} = 63 V$; $U_{RAC} = 40 V$

C (μF)	DIMENSIONS $w_{max} \times h_{max} \times l_{max}$ (mm)	MASS (g) ⁽¹⁾	CATALOG NUMBER BFC2 367 XXYYY AND PACKAGING						C-VALUE ..YYY
			LOOSE IN BOX				AMMOPACK		
			$l_t = 4.0 \text{ mm} + 1.0 \text{ mm} / - 0.5 \text{ mm}$		$l_t = 22.0 \text{ mm} \pm 4.0 \text{ mm}$		$H = 18.5 \text{ mm}$		
			C-TOL. = $\pm 10 \%$	C-TOL. = $\pm 5 \%$	C-TOL. = $\pm 10 \%$	C-TOL. = $\pm 5 \%$	C-TOL. = $\pm 10 \%$	C-TOL. = $\pm 5 \%$	
			XX (SPQ)	XX (SPQ)	XX (SPQ)	XX (SPQ)	XX (SPQ)	XX (SPQ)	
Pitch = 7.5 mm + 0.4 mm / - 0.2 mm; $d_t = 0.60 \text{ mm} \pm 0.06 \text{ mm}$									
0.12	4.0 x 9.5 x 10.0	0.23	15...	16...	11...	12...	13...	17...	124
0.15			(1000)	(1000)	(1000)	(1000)	(1500)	(1500)	154
0.18									184
0.22									224
0.27	4.5 x 10.0 x 10.5	0.37	15...	16...	11...	12...	13...	17...	274
0.33	5.0 x 10.5 x 10.5	0.39	15...	16...	11...	12...	13...	17...	334
0.39			(1000)	(1000)	(1000)	(1000)	(1000)	(1000)	394
0.47	5.5 x 11.0 x 10.5	0.44	15...	16...	11...	12...	13...	17...	474
0.56	5.5 x 12.0 x 10.5	0.46	15...	16...	11...	12...	13...	17...	564
0.68			(1000)	(1000)	(1000)	(1000)	(1000)	(1000)	684
0.82									824
1.0									105

Notes

- SPQ = Standard Packing Quantity
- ⁽¹⁾ Net weight for short lead products only

$U_{RDC} = 100 V$; $U_{RAC} = 63 V$

C (μF)	DIMENSIONS $w_{max} \times h_{max} \times l_{max}$ (mm)	MASS (g) ⁽¹⁾	CATALOG NUMBER BFC2 367 XXYYY AND PACKAGING						C-VALUE ..YYY
			LOOSE IN BOX				AMMOPACK		
			$l_t = 4.0 \text{ mm} + 1.0 \text{ mm} / - 0.5 \text{ mm}$		$l_t = 22.0 \text{ mm} \pm 4.0 \text{ mm}$		$H = 18.5 \text{ mm}$		
			C-TOL. = $\pm 10 \%$	C-TOL. = $\pm 5 \%$	C-TOL. = $\pm 10 \%$	C-TOL. = $\pm 5 \%$	C-TOL. = $\pm 10 \%$	C-TOL. = $\pm 5 \%$	
			XX (SPQ)	XX (SPQ)	XX (SPQ)	XX (SPQ)	XX (SPQ)	XX (SPQ)	
Pitch = 7.5 mm + 0.4 mm / - 0.2 mm; $d_t = 0.60 \text{ mm} \pm 0.06 \text{ mm}$									
0.039	4.0 x 9.5 x 10.0	0.23	25...	26...	21...	22...	23...	27...	393
0.047			(1000)	(1000)	(1000)	(1000)	(1500)	(1500)	473
0.056									563
0.068									683
0.082									823
0.10									104
0.12	4.5 x 10.0 x 10.5	0.37	25...	26...	21...	22...	23...	27...	124
0.15	5.0 x 10.5 x 10.5	0.39	25...	26...	21...	22...	23...	27...	154
0.18			(1000)	(1000)	(1000)	(1000)	(1000)	(1000)	184
0.22	5.5 x 11.5 x 10.5	0.44	25...	26...	21...	22...	23...	27...	224
0.27	6.0 x 12.5 x 10.5	0.55	25...	26...	21...	22...	23...	27...	274
0.33			(1000)	(1000)	(1000)	(1000)	(1000)	(1000)	334
0.39									394
0.47									474

Notes

- SPQ = Standard Packing Quantity
- ⁽¹⁾ Net weight for short lead products only



U_{RDC} = 250 V; U_{RAC} = 160 V

C (µF)	DIMENSIONS w _{max.} x h _{max.} x l _{max.} (mm)	MASS (g) ⁽¹⁾	CATALOG NUMBER BFC2 367 XXYYY AND PACKAGING						C-VALUE ..YYY
			LOOSE IN BOX				AMMOPACK		
			l _t = 4.0 mm + 1.0 mm / - 0.5 mm		l _t = 22.0 mm ± 4.0 mm		H = 18.5 mm		
			C-TOL. = ± 10 %	C-TOL. = ± 5 %	C-TOL. = ± 10 %	C-TOL. = ± 5 %	C-TOL. = ± 10 %	C-TOL. = ± 5 %	
XX (SPQ)	XX (SPQ)	XX (SPQ)	XX (SPQ)	XX (SPQ)	XX (SPQ)	XX (SPQ)	XX (SPQ)		
Pitch = 7.5 mm + 0.4 mm / - 0.2 mm; d _t = 0.60 mm ± 0.06 mm									
0.018	4.0 x 9.5 x 10.0	0.23	45...	46...	41...	42...	43...	47...	183
0.022			(1000)	(1000)	(1000)	(1000)	(1500)	(1500)	223
0.027									273
0.033									333
0.039									393
0.047									473
0.056							563		
0.068	4.5 x 10.0 x 10.0	0.37	45...	46...	41...	42...	43...	47...	683
0.082			(1000)	(1000)	(1000)	(1000)	(1000)	(1000)	823
0.10	5.0 x 10.5 x 10.0	0.39	45...	46...	41...	42...	43...	47...	104
0.12	5.5 x 11.0 x 10.0	0.42	45...	46...	41...	42...	43...	47...	124
			(1000)	(1000)	(1000)	(1000)	(1000)	(1000)	
0.15	5.5 x 12.5 x 10.0	0.48	45...	46...	41...	42...	43...	47...	154

Notes

- SPQ = Standard Packing Quantity
- ⁽¹⁾ Net weight for short lead products only

U_{RDC} = 400 V; U_{RAC} = 220 V

C (µF)	DIMENSIONS w _{max.} x h _{max.} x l _{max.} (mm)	MASS (g) ⁽¹⁾	CATALOG NUMBER BFC2 367 XXYYY AND PACKAGING						C-VALUE ..YYY
			LOOSE IN BOX				AMMOPACK		
			l _t = 4.0 mm + 1.0 mm / - 0.5 mm		l _t = 22.0 mm ± 4.0 mm		H = 18.5 mm		
			C-TOL. = ± 10 %	C-TOL. = ± 5 %	C-TOL. = ± 10 %	C-TOL. = ± 5 %	C-TOL. = ± 10 %	C-TOL. = ± 5 %	
XX (SPQ)	XX (SPQ)	XX (SPQ)	XX (SPQ)	XX (SPQ)	XX (SPQ)	XX (SPQ)	XX (SPQ)		
Pitch = 7.5 mm + 0.4 mm / - 0.2 mm; d _t = 0.60 mm ± 0.06 mm									
0.0033	4.0 x 9.5 x 10.0	0.23	55...	56...	51...	52...	53...	57...	332
0.0039									392
0.0047									472
0.0056									562
0.0068									682
0.0082									822
0.010									103
0.012									123
0.015	153								
0.018	4.5 x 10.0 x 10.0	0.37	55...	56...	51...	52...	53...	57...	183
0.022	5.0 x 10.5 x 10.0	0.39	55...	56...	51...	52...	53...	57...	223
0.027	4.0 x 9.5 x 10.0	0.23	55...	56...	51...	52...	53...	57...	273
0.033	4.5 x 10.0 x 10.0	0.37	55...	56...	51...	52...	53...	57...	333
0.039	5.0 x 10.5 x 10.0	0.39	55...	56...	51...	52...	53...	57...	393
0.047			(1000)	(1000)	(1000)	(1000)	(1000)	(1000)	(1000)
0.056	5.5 x 11.0 x 10.0	0.42	55...	56...	51...	52...	53...	57...	563

Notes

- SPQ = Standard Packing Quantity
- ⁽¹⁾ Net weight for short lead products only



MOUNTING

Normal Use

The capacitors are designed for mounting on printed-circuit boards. The capacitors packed in bandoliers are designed for mounting in printed-circuit boards by means of automatic insertion machines.

For detailed tape specifications refer to packaging information: www.vishay.com/doc?28139

Specific Method of Mounting to Withstand Vibration and Shock

In order to withstand vibration and shock tests, it must be ensured that the underside and the kinks are in good contact with the printed-circuit board.

- For pitches ≤ 15 mm capacitors shall be mechanically fixed by the leads
- For larger pitches the capacitors shall be mounted in the same way and the body clamped

SOLDERING CONDITIONS

For general soldering conditions and wave soldering profile, we refer to the application note:

“Soldering Guidelines for Film Capacitors”: www.vishay.com/doc?28171

Storage Temperature

$T_{stg} = -25$ °C to $+35$ °C with RH maximum 75 % without condensation

Ratings and Characteristics Reference Conditions

Unless otherwise specified, all electrical values apply to an ambient free air temperature of 23 °C ± 1 °C, an atmospheric pressure of 86 kPa to 106 kPa and a relative humidity of 50 % ± 2 %.

For reference testing, a conditioning period shall be applied over 96 h ± 4 h by heating the products in a circulating air oven at the rated temperature and a relative humidity not exceeding 20 %.



CHARACTERISTICS

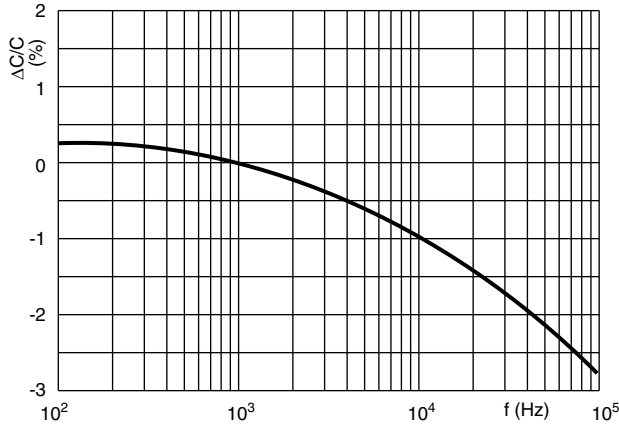

Capacitance as a function of frequency (typical curve)

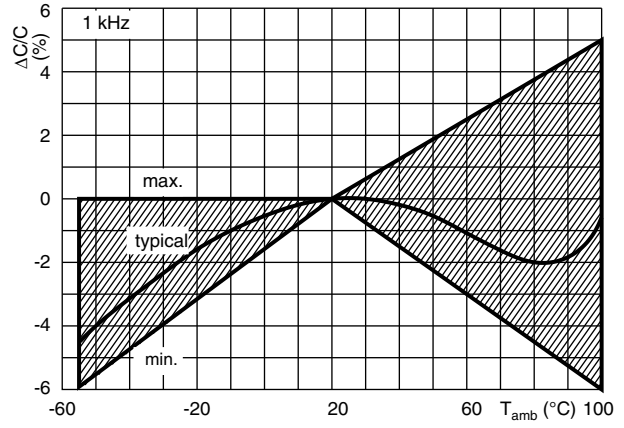

Capacitance as a function of ambient temperature (typical curve)

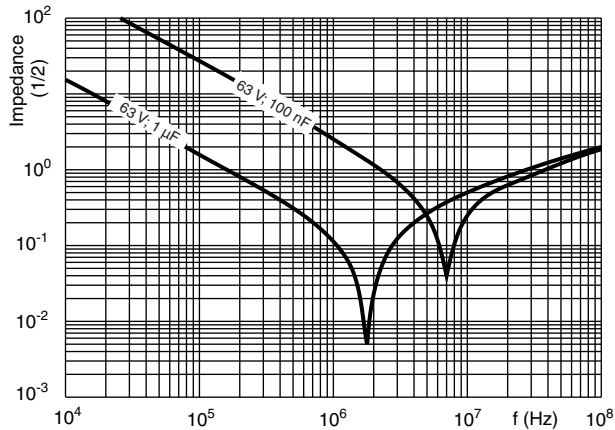

Impedance as a function of frequency (typical curve)

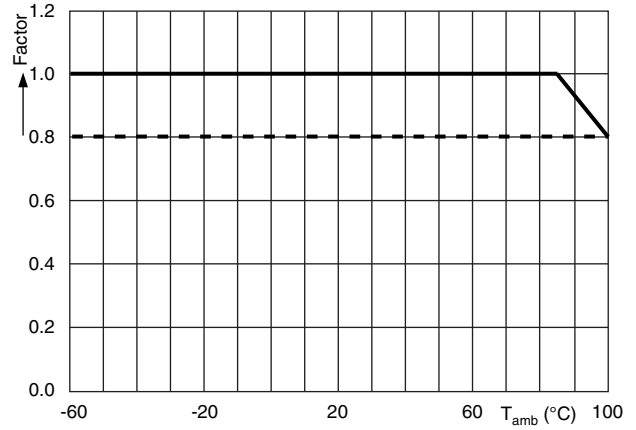

Max. DC and AC voltage as a function of temperature

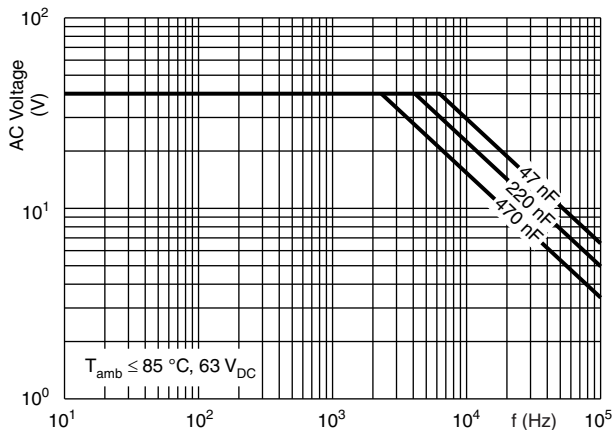

Max. RMS voltage as a function of frequency

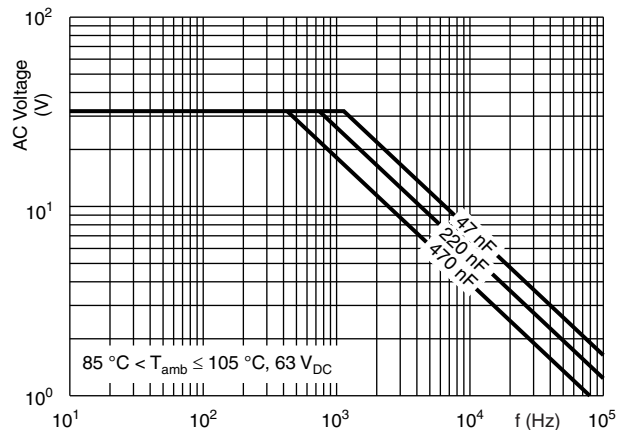

Max. RMS voltage as a function of frequency

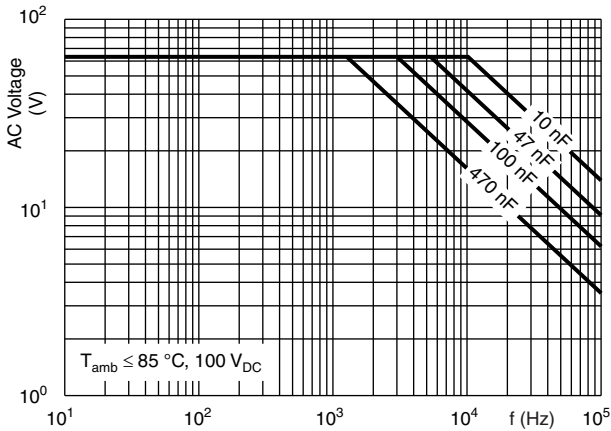

Max. RMS voltage as a function of frequency

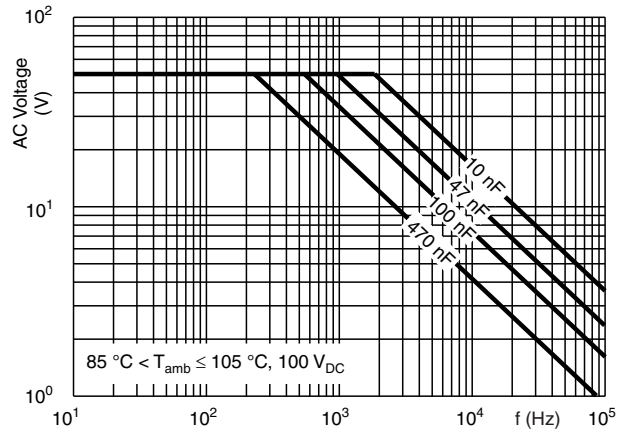

Max. RMS voltage as a function of frequency

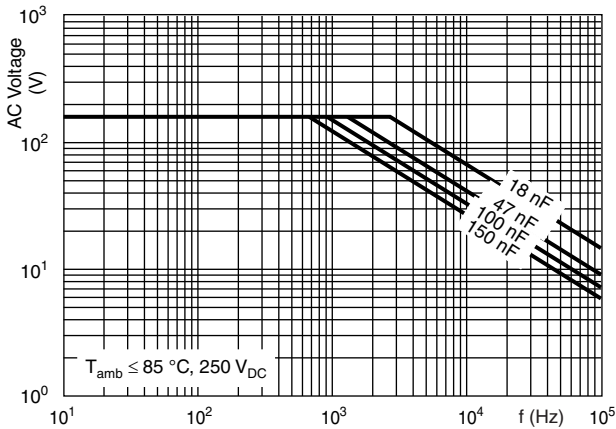

Max. RMS voltage as a function of frequency

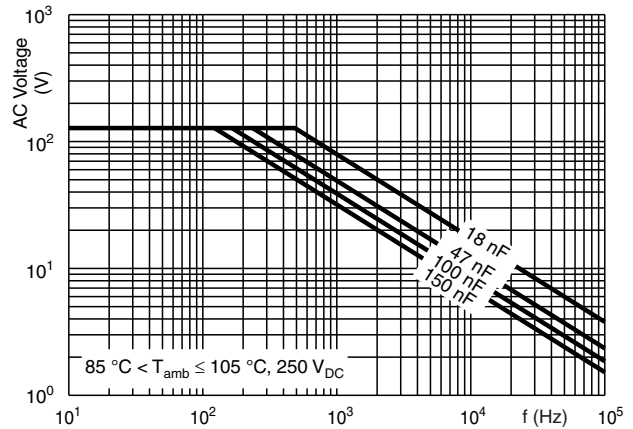

Max. RMS voltage as a function of frequency

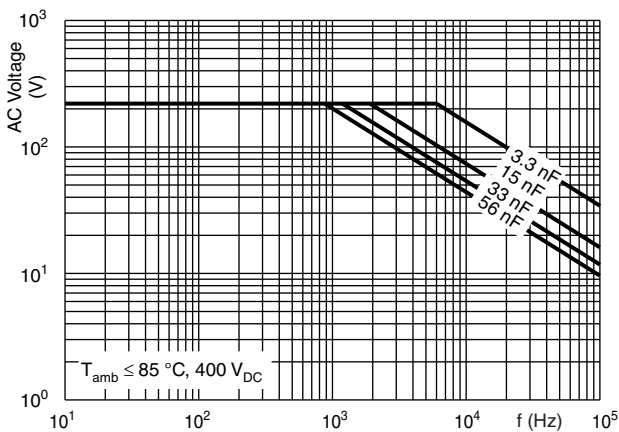

Max. RMS voltage as a function of frequency

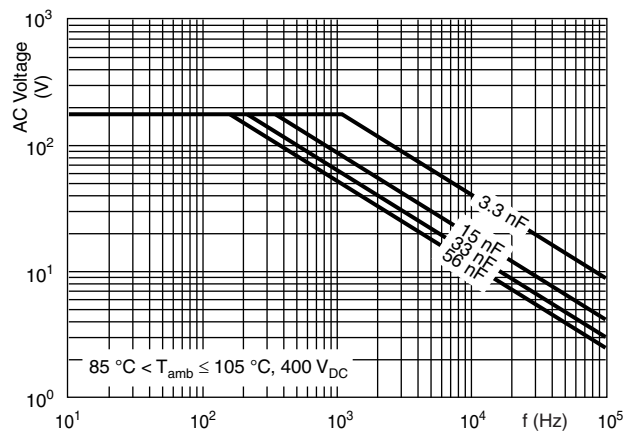

Max. RMS voltage as a function of frequency



MAXIMUM RMS CURRENT (SINEWAVE) AS A FUNCTION OF FREQUENCY

The maximum RMS current is defined by $I_{AC} = \omega \times C \times U_{AC}$

U_{AC} is the maximum AC voltage depending on the ambient temperature in the curves “Max. RMS voltage and AC current as a function of frequency”.

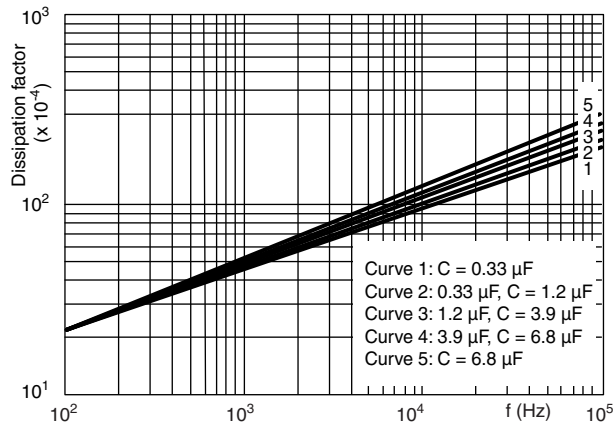

Tangent of loss angle as a function of frequency

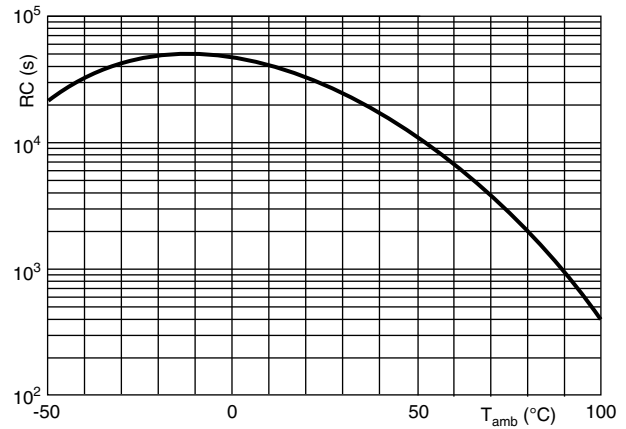

Insulation resistance as a function of the ambient temperature (typical curve)

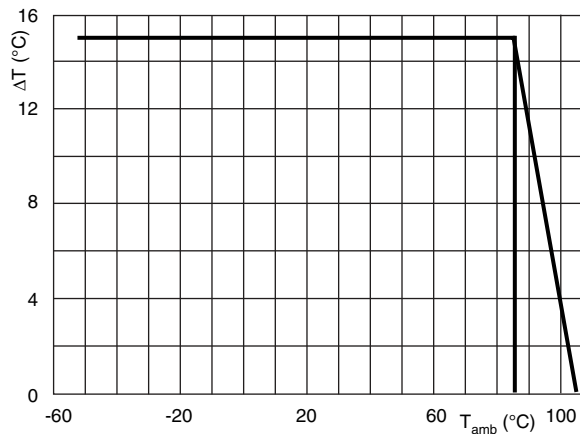

Maximum allowed component temperature rise (ΔT) as a function of the ambient temperature (T_{amb})

HEAT CONDUCTIVITY (G) AS A FUNCTION OF (ORIGINAL) PITCH AND CAPACITOR BODY THICKNESS IN mW/°C

$W_{MAX.}$ (mm)	HEAT CONDUCTIVITY (mW/°C)
3.5	3.0
4.0	3.5
4.5	3.5
5.0	4.0
5.5	4.0
6.0	4.5
6.5	5.0

POWER DISSIPATION AND MAXIMUM COMPONENT TEMPERATURE RISE

The power dissipation must be limited in order not to exceed the maximum allowed component temperature rise as a function of the free ambient temperature.

The power dissipation can be calculated according type detail specification “HQN-384-01/101: Technical Information Film Capacitors”.

The component temperature rise (ΔT) can be measured (see section “Measuring the Component Temperature” for more details) or calculated by $\Delta T = P/G$:

- ΔT = component temperature rise ($^{\circ}\text{C}$)
- P = power dissipation of the component (mW)
- G = heat conductivity of the component (mW/ $^{\circ}\text{C}$)

MEASURING THE COMPONENT TEMPERATURE

A thermocouple must be attached to the capacitor body as in:

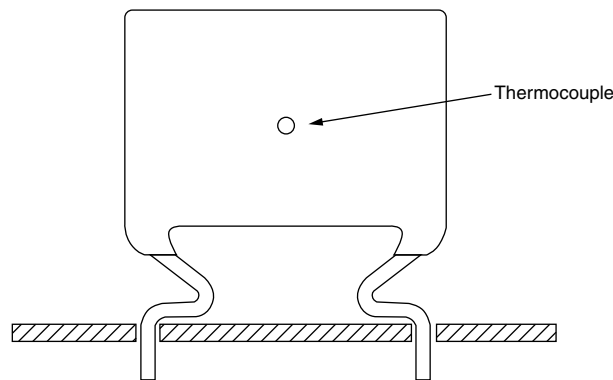

The temperature is measured in unloaded (T_{amb}) and maximum loaded condition (T_{C}).

The temperature rise is given by $\Delta T = T_{\text{C}} - T_{\text{amb}}$.

To avoid radiation or convection, the capacitor should be tested in a wind-free box.

APPLICATION NOTE AND LIMITING CONDITIONS

These capacitors are not suitable for mains applications as across-the-line capacitors without additional protection, as described hereunder. These mains applications are strictly regulated in safety standards and therefore electromagnetic interference suppression capacitors conforming the standards must be used.

To select the capacitor for a certain application, the following conditions must be checked:

1. For capacitors connected in parallel, normally the proof voltage and possibly the rated voltage must be reduced. For information depending of the capacitance value and the number of parallel connections contact: dc-film@vishay.com
2. The peak voltage (U_{P}) shall not be greater than the rated DC voltage (U_{RDC})
3. The peak-to-peak voltage ($U_{\text{P-P}}$) shall not be greater than $2\sqrt{2} \times U_{\text{RAC}}$ to avoid the ionization inception level
4. The voltage pulse slope (dU/dt) shall not exceed the rated voltage pulse slope in an RC-circuit at rated voltage and without ringing. If the pulse voltage is lower than the rated DC voltage, the rated voltage pulse slope may be multiplied by U_{RDC} and divided by the applied voltage.

For all other pulses following equation must be fulfilled:

$$2 \times \int_0^T \left(\frac{dU}{dt} \right)^2 \times dt < U_{\text{RDC}} \times \left(\frac{dU}{dt} \right)_{\text{rated}}$$

T is the pulse duration.

The rated voltage pulse slope is valid for ambient temperatures up to 85°C . For higher temperatures a derating factor of 3 % per K shall be applied.

5. The maximum component surface temperature rise must be lower than the limits (see graph “Max. allowed component temperature rise”).
6. Since in circuits used at voltages over 280 V peak-to-peak the risk for an intrinsically active flammability after a capacitor breakdown (short circuit) increases, it is recommended that the power to the component is limited to 100 times the values mentioned in the table: “Heat Conductivity”
7. When using these capacitors as across-the-line capacitor in the input filter for mains applications or as series connected with an impedance to the mains the applicant must guarantee that the following conditions are fulfilled in any case (spikes and surge voltages from the mains included).

VOLTAGE CONDITIONS FOR 6 ABOVE

ALLOWED VOLTAGES	$T_{amb} \leq 85\text{ }^{\circ}\text{C}$	$85\text{ }^{\circ}\text{C} < T_{amb} \leq 105\text{ }^{\circ}\text{C}$
Maximum continuous RMS voltage	U_{RAC}	$0.8 \times U_{RAC}$
Maximum temperature RMS-overvoltage (< 24 h)	$1.25 \times U_{RAC}$	U_{RAC}
Maximum peak voltage (V_{O-P}) (< 2 s)	$1.6 \times U_{RDC}$	$1.3 \times U_{RDC}$

Example

$C = 330\text{ nF} - 63\text{ V}$ used for the voltage signal shown in next drawing.

$U_{P-P} = 40\text{ V}$; $U_P = 35\text{ V}$; $T_1 = 100\text{ }\mu\text{s}$; $T_2 = 200\text{ }\mu\text{s}$

The ambient temperature is $35\text{ }^{\circ}\text{C}$

Checking conditions:

1. The peak voltage $U_P = 35\text{ V}$ is lower than 63 V_{DC}
2. The peak-to-peak voltage 40 V is lower than $2\sqrt{2} \times 40\text{ V}_{AC} = 113\text{ V}_{P-P}$
3. The voltage pulse slope $(dU/dt) = 40\text{ V}/100\text{ }\mu\text{s} = 0.4\text{ V}/\mu\text{s}$
This is lower than $110\text{ V}/\mu\text{s}$ (see specific reference data for each version)
4. The dissipated power is 16.2 mW as calculated with fourier terms
The temperature rise for $W_{max.} = 4.5\text{ mm}$ and pitch = 5 mm will be $16.2\text{ mW}/2.5\text{ mW}/^{\circ}\text{C} = 6.5\text{ }^{\circ}\text{C}$
This is lower than $15\text{ }^{\circ}\text{C}$ temperature rise at $35\text{ }^{\circ}\text{C}$, according figure “Max. allowed component temperature rise”
5. Not applicable
6. Not applicable

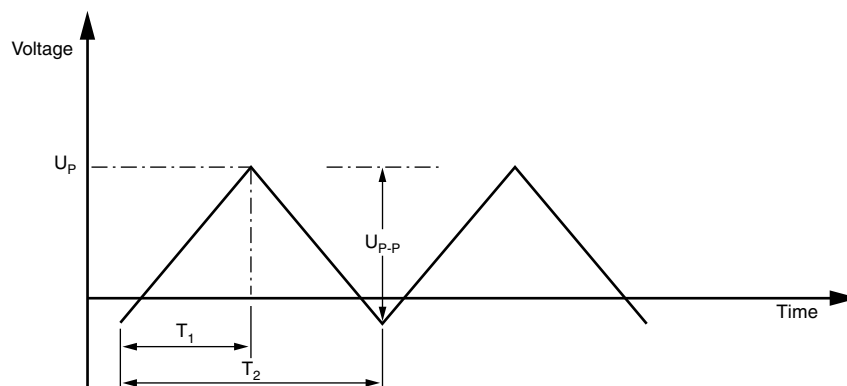
Voltage Signal



INSPECTION REQUIREMENTS

General Notes

Sub-clause numbers of tests and performance requirements refer to the "Sectional Specification, Publication IEC 60384-2 and Specific Reference Data".

Group C Inspection Requirements

SUB-CLAUSE NUMBER AND TEST	CONDITIONS	PERFORMANCE REQUIREMENTS
SUB-GROUP C1A PART OF SAMPLE OF SUB-GROUP C1		
4.1 Dimensions (detail)		As specified in chapters "General Data" of this specification
4.3.1 Initial measurements	Capacitance Tangent of loss angle: for C ≤ 470 nF at 100 kHz or for C > 470 nF at 10 kHz	
4.3 Robustness of terminations	Tensile: load 10 N; 10 s Bending: load 5 N; 4 x 90°	No visible damage
4.4 Resistance to soldering heat	Method: 1A Solder bath: 280 °C ± 5 °C Duration: 10 s	
4.14 Component solvent resistance	Isopropylalcohol at room temperature Method: 2 Immersion time: 5 min ± 0.5 min Recovery time: min. 1 h, max. 2 h	
4.4.2 Final measurements	Visual examination	No visible damage Legible marking
	Capacitance	ΔC/C ≤ 2 % of the value measured initially
	Tangent of loss angle	Increase of tan δ ≤ 0.005 for: C ≤ 100 nF or ≤ 0.010 for: 100 nF < C ≤ 220 nF or ≤ 0.015 for: 220 nF < C ≤ 470 nF and ≤ 0.003 for: C > 470 nF Compared to values measured in 4.3.1
SUB-GROUP C1B PART OF SAMPLE OF SUB-GROUP C1		
4.6.1 Initial measurements	Capacitance Tangent of loss angle: for C ≤ 470 nF at 100 kHz or for C > 470 nF at 10 kHz	No visible damage
4.6 Rapid change of temperature	θA = -55 °C θB = +105 °C 5 cycles Duration t = 30 min	
4.7 Vibration	Visual examination Mounting: See section "Mounting" of this specification Procedure B4 Frequency range: 10 Hz to 55 Hz Amplitude: 0.75 mm or Acceleration 98 m/s ² (whichever is less severe) Total duration 6 h	No visible damage
4.7.2 Final inspection	Visual examination	No visible damage



SUB-CLAUSE NUMBER AND TEST	CONDITIONS	PERFORMANCE REQUIREMENTS
4.9 Shock	Mounting: See section "Mounting" of this specification Pulse shape: half sine Acceleration: 490 m/s ² Duration of pulse: 11 ms	
4.9.3 Final measurements	Visual examination Capacitance Tangent of loss angle Insulation resistance	No visible damage $ \Delta C/C \leq 3\%$ of the value measured in 4.6.1 Increase of $\tan \delta$ ≤ 0.005 for: $C \leq 100$ nF or ≤ 0.010 for: 100 nF < $C \leq 220$ nF or ≤ 0.015 for: 220 nF < $C \leq 470$ nF and ≤ 0.003 for: $C > 470$ nF Compared to values measured in 4.6.1 As specified in section "Insulation Resistance" of this specification
SUB-GROUP C1 COMBINED SAMPLE OF SPECIMENS OF SUB-GROUPS C1A AND C1B		
4.10 Climatic sequence		
4.10.2 Dry heat	Temperature: +105 °C Duration: 16 h	
4.10.3 Damp heat cyclic Test Db, first cycle		
4.10.4 Cold	Temperature: -55 °C Duration: 2 h	
4.10.6 Damp heat cyclic Test Db, remaining cycles		
4.10.6.2 Final measurements	Voltage proof = U_{RDC} for 1 min within 15 min after removal from test chamber Visual examination Capacitance Tangent of loss angle Insulation resistance	No breakdown of flash-over No visible damage Legible marking $ \Delta C/C \leq 5\%$ of the value measured in 4.4.2 or 4.9.3 Increase of $\tan \delta$ ≤ 0.007 for: $C \leq 100$ nF or ≤ 0.010 for: 100 nF < $C \leq 220$ nF or ≤ 0.015 for: 220 nF < $C \leq 470$ nF and ≤ 0.005 for: $C > 470$ nF Compared to values measured in 4.3.1 or 4.6.1 $\geq 50\%$ of values specified in section "Insulation Resistance" of this specification



SUB-CLAUSE NUMBER AND TEST	CONDITIONS	PERFORMANCE REQUIREMENTS
SUB-GROUP C2		
4.11 Damp heat steady state	56 days, 40 °C, 90 % to 95 % RH	
4.11.1 Initial measurements	Capacitance Tangent of loss angle at 1 kHz	
4.11.3 Final measurements	Voltage proof = U_{RDC} for 1 min within 15 min after removal from test chamber Visual examination Capacitance Tangent of loss angle Insulation resistance	No breakdown of flash-over No visible damage Legible marking $ \Delta C/C \leq 5\%$ of the value measured in 4.11.1. Increase of $\tan \delta \leq 0.005$ Compared to values measured in 4.11.1 $\geq 50\%$ of values specified in section "Insulation Resistance" of this specification
SUB-GROUP C3		
4.12 Endurance	Duration: 2000 h 1.25 x U_{RDC} at 85 °C 1.0 x U_{RDC} at 105 °C	
4.12.1 Initial measurements	Capacitance Tangent of loss angle: for $C \leq 470$ nF at 100 kHz or for $C > 470$ nF at 10 kHz	
4.12.5 Final measurements	Visual examination Capacitance Tangent of loss angle Insulation resistance	No visible damage Legible marking $ \Delta C/C \leq 5\%$ compared to values measured in 4.12.1 Increase of $\tan \delta$ ≤ 0.005 for: $C \leq 100$ nF or ≤ 0.010 for: 100 nF < $C \leq 220$ nF or ≤ 0.015 for: 220 nF < $C \leq 470$ nF and ≤ 0.003 for: $C > 470$ nF Compared to values measured in 4.12.1 $\geq 50\%$ of values specified in section "Insulation Resistance" of this specification
SUB-GROUP C4		
4.13 Charge and discharge	10 000 cycles Charged to $U_R V_{DC}$ Discharge resistance: $R = \frac{U_R}{C \times 2.5 \times (dU/dt)_R}$	
4.13.1 Initial measurements	Capacitance Tangent of loss angle: for $C \leq 470$ nF at 100 kHz or for $C > 470$ nF at 10 kHz	
4.13.3 Final measurements	Capacitance Tangent of loss angle Insulation resistance	$ \Delta C/C \leq 3\%$ compared to values measured in 4.13.1 Increase of $\tan \delta$ ≤ 0.005 for: $C \leq 100$ nF or ≤ 0.010 for: 100 nF < $C \leq 220$ nF or ≤ 0.015 for: 220 nF < $C \leq 470$ nF and ≤ 0.003 for: $C > 470$ nF Compared to values measured in 4.13.1 $\geq 50\%$ of values specified in section "Insulation Resistance" of this specification



Disclaimer

ALL PRODUCT, PRODUCT SPECIFICATIONS AND DATA ARE SUBJECT TO CHANGE WITHOUT NOTICE TO IMPROVE RELIABILITY, FUNCTION OR DESIGN OR OTHERWISE.

Vishay Intertechnology, Inc., its affiliates, agents, and employees, and all persons acting on its or their behalf (collectively, "Vishay"), disclaim any and all liability for any errors, inaccuracies or incompleteness contained in any datasheet or in any other disclosure relating to any product.

Vishay makes no warranty, representation or guarantee regarding the suitability of the products for any particular purpose or the continuing production of any product. To the maximum extent permitted by applicable law, Vishay disclaims (i) any and all liability arising out of the application or use of any product, (ii) any and all liability, including without limitation special, consequential or incidental damages, and (iii) any and all implied warranties, including warranties of fitness for particular purpose, non-infringement and merchantability.

Statements regarding the suitability of products for certain types of applications are based on Vishay's knowledge of typical requirements that are often placed on Vishay products in generic applications. Such statements are not binding statements about the suitability of products for a particular application. It is the customer's responsibility to validate that a particular product with the properties described in the product specification is suitable for use in a particular application. Parameters provided in datasheets and / or specifications may vary in different applications and performance may vary over time. All operating parameters, including typical parameters, must be validated for each customer application by the customer's technical experts. Product specifications do not expand or otherwise modify Vishay's terms and conditions of purchase, including but not limited to the warranty expressed therein.

Hyperlinks included in this datasheet may direct users to third-party websites. These links are provided as a convenience and for informational purposes only. Inclusion of these hyperlinks does not constitute an endorsement or an approval by Vishay of any of the products, services or opinions of the corporation, organization or individual associated with the third-party website. Vishay disclaims any and all liability and bears no responsibility for the accuracy, legality or content of the third-party website or for that of subsequent links.

Except as expressly indicated in writing, Vishay products are not designed for use in medical, life-saving, or life-sustaining applications or for any other application in which the failure of the Vishay product could result in personal injury or death. Customers using or selling Vishay products not expressly indicated for use in such applications do so at their own risk. Please contact authorized Vishay personnel to obtain written terms and conditions regarding products designed for such applications.

No license, express or implied, by estoppel or otherwise, to any intellectual property rights is granted by this document or by any conduct of Vishay. Product names and markings noted herein may be trademarks of their respective owners.