

Title	<i>Reference Design Report for a 225 W (286 W Peak) Power Factor Corrected LLC Power Supply Using HiperPLC (PLC810PG)</i>
Specification	90 VAC to 265 VAC Input 225 W (286 W Peak) Total Output Power 5 V _{SB} at 0.5 W 5 V at 9.5 W 12 V at 48 W (60 W Peak) 24 V at 168 W (216 W Peak)
Application	LCD TV
Author	Applications Engineering Department
Document Number	RDR-189
Date	September 9, 2009
Revision	1.0.5

Summary and Features

- Integrated PFC and LLC controller
- Continuous mode PFC using small low-cost EE Sendust core and magnet wire
- Frequency and Phase locked PFC and LLC for ripple cancellation in bulk capacitor for reduced ripple current, reduced bulk capacitor and reduced EMI filter cost
- Tight LLC duty-cycle matching
- Tight LLC dead-time control
- Brownout detection circuit
- >92% full load PFC efficiency at 90 VAC using conventional ultrafast rectifier
- >93% full load LLC efficiency

PATENT INFORMATION

The products and applications illustrated herein (including transformer construction and circuits external to the products) may be covered by one or more U.S. and foreign patents, or potentially by pending U.S. and foreign patent applications assigned to Power Integrations. A complete list of Power Integrations' patents may be found at www.powerint.com. Power Integrations grants its customers a license under certain patent rights as set forth at <http://www.powerint.com/ip.htm>.

Table of Contents

1	Introduction.....	4
2	Power Supply Specification	7
3	Schematic.....	8
4	Circuit Description	11
4.1	Input Filter / Boost Converter.....	11
4.1.1	EMI Filtering	11
4.1.2	Inrush limiting.....	11
4.1.3	Main PFC Stage.....	11
4.2	Main LLC Output	12
4.2.1	LLC Input Stage	12
4.2.2	LLC Outputs	12
4.2.3	Switched +5V Output	12
4.3	Controller.....	12
4.3.1	PFC Control	12
4.3.2	Bypassing/Ground Isolation	13
4.3.3	LLC Control	13
4.4	LLC Secondary Control Circuits	13
4.4.1	Voltage Feedback	13
4.5	5 V Standby/Primary Bias Supply/Remote Start.....	13
4.5.1	5 V Flyback Supply.....	14
4.5.2	Primary Bias regulator/Remote Start.....	14
4.5.3	Brownout Shutdown Circuit	14
5	PCB Layout	15
6	Bill of Materials	17
7	Magnetics	22
7.1	Main LLC 12/24 V Transformer (T2) Specification	22
7.1.1	Electrical Diagram	22
7.1.2	Electrical Specifications.....	22
7.2	5V Standby Supply Transformer (T1) Specification)	23
7.2.1	Electrical Diagram	23
7.2.2	Electrical Specifications.....	23
7.2.3	Materials.....	23
7.2.4	Build Diagram.....	24
7.2.5	Construction	24
7.3	PFC Choke (L4) Specification	25
7.3.1	Electrical Diagram	25
7.3.2	Electrical Specification	25
7.3.3	Materials.....	26
7.3.4	Build Diagram.....	26
7.3.5	Winding Instructions.....	27
7.4	Ground Choke (L3) Specification	28
7.4.1	Schematic Diagram.....	28
7.4.2	Materials.....	28
7.4.3	Winding Instructions.....	28



8	LLC Transformer Spreadsheet	29
9	RD-189 Performance Data	36
9.1	LLC Stage Efficiency	36
9.2	Total Efficiency	37
9.3	+5 V Standby Output – Input Power vs Output Power	38
9.4	Standby Load Raw Data	39
9.5	No-Load Input Power	40
9.6	THD and Power Factor	41
9.7	Output Regulation	43
10	Waveforms	44
10.1	Input Voltage and Current	44
10.2	LLC Primary Voltage and Current	45
10.3	PFC Switch Voltage and Current - Normal Operation	46
10.4	AC Input Current and PFC Output Voltage during Startup	46
10.5	LLC Startup	47
10.6	LLC Output Short Circuit	48
10.7	Output Voltage during Startup and Shutdown	49
10.7.1	Standby Supply	49
10.7.2	LLC (Main) Supply	50
10.8	Output Holdup Time	52
10.9	Output Ripple Measurements	53
10.9.1	Ripple Measurement Technique	53
10.9.2	Full Load Output Ripple Results	54
10.9.3	Output Load Step Response	55
11	Temperature Profiles	56
11.1	Thermal Results Summary	57
11.1.1	Testing Conditions	57
11.2	90 VAC, 47 Hz, 225 W _{OUT}	58
11.3	108 VAC, 57 Hz, 225 W _{OUT}	58
11.4	108 VAC, 57 Hz, 185 W _{OUT}	59
11.5	Alternate PFC Choke Designs for Lower Operating Temperature	60
11.5.1	34 mm Toroidal Choke	60
11.5.2	PFC Choke Using EE41/33 Core	63
12	LLC Gain-Phase	66
13	Conducted EMI	68
14	Line Surge	69
15	Revision History	70

Important Note:

Although this board is designed to satisfy safety isolation requirements, the engineering prototype has not been agency approved. Therefore, all testing should be performed using an isolation transformer to provide the AC input to the prototype board.



1 Introduction

This engineering report describes a 286 W reference design power supply for flat panel displays (LCD TVs) and also serves as a general purpose evaluation board for the PLC810PG

The design is based on the PLC810PG controller IC which integrates both continuous current mode (CCM) boost PFC and resonant half-bridge (LLC) control functions together with a high-side driver for the upper MOSFET of the LLC stage and a low-side LLC driver.

RD189 demonstrates a design using the commonly employed single transformer and resonant inductor magnetic component (integrated magnetics) for the LLC stage (common in display applications). However, the PLC810 may as easily be used with separated transformer and resonating inductor. PI design materials support both approaches.

The board also includes a standby power supply using a TNY275PN from the TinySwitch-III IC family. This provides the 5 V output during both normal operation and standby.



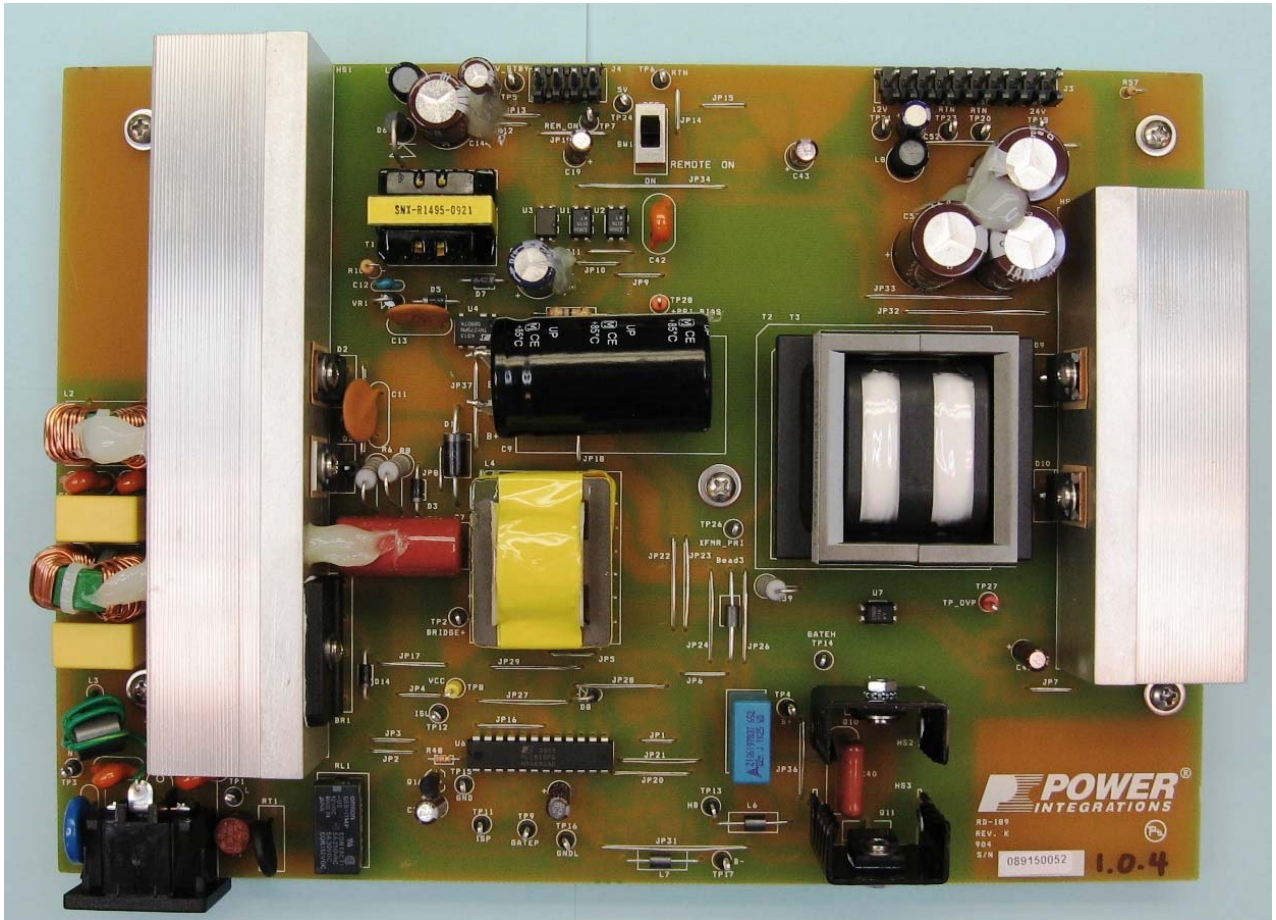

Figure 1 – RD189 Photograph, Top View.



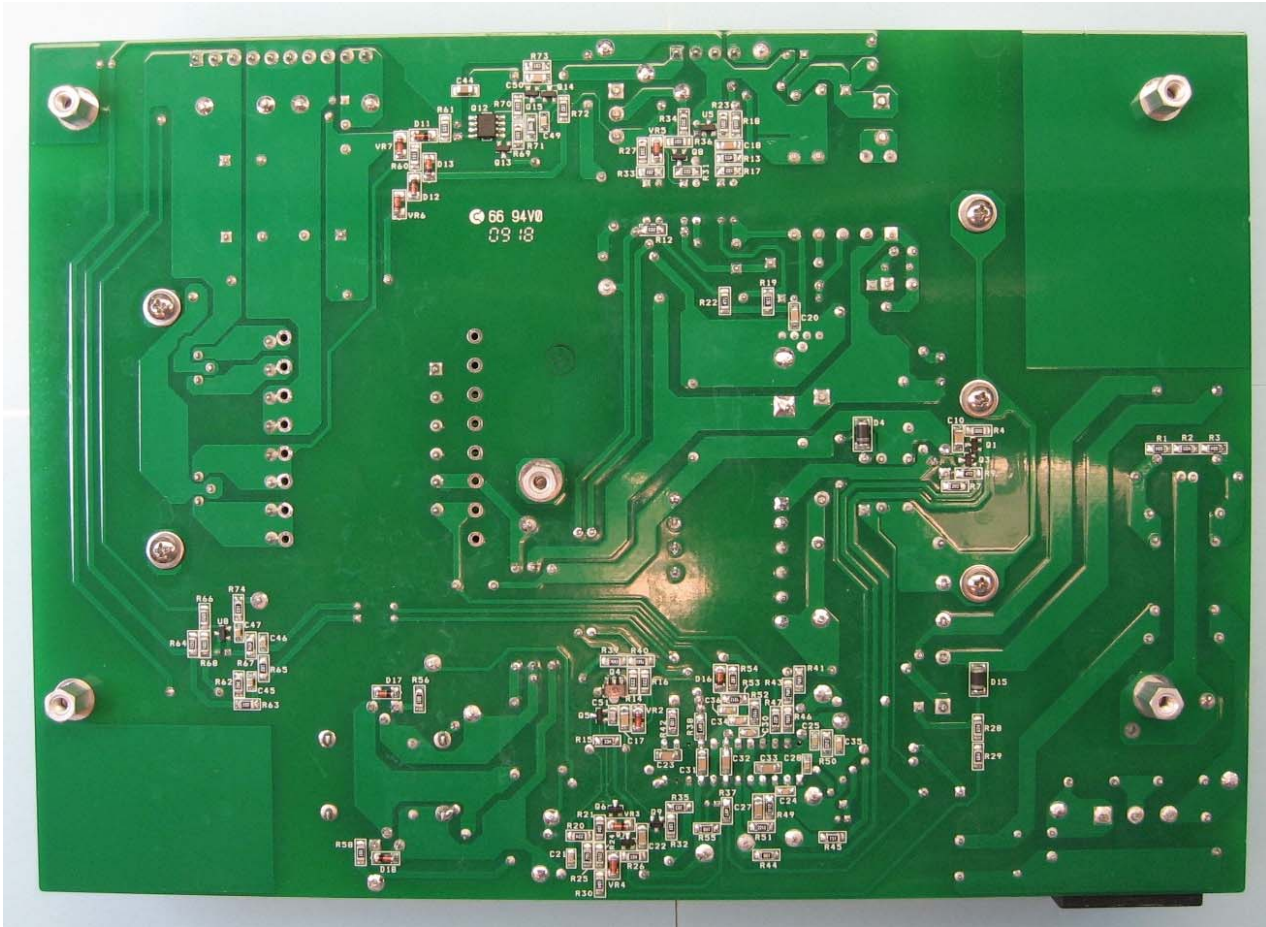

Figure 2 – RD-189 Photograph, Bottom View.



2 Power Supply Specification

The table below represents the minimum acceptable performance of the design. Actual performance is listed in the results section.

Description	Symbol	Min	Typ	Max	Units	Comment
Input						
Voltage	V_{IN}	90		265	VAC	3 Wire input.
Frequency	f_{LINE}	47	50/60	64	Hz	
Power Factor	PF	0.99				Full load, 100/115/230 VAC
No-load Input Power (230 VAC)				0.2	W	
No-load Input Power (100/115VAC)				0.08	W	
Available Standby Output Power	$P_{IN(1W)}$	0.6			W	For 1 W input power at 115/230 VAC
	$P_{IN(2W)}$	1.3			W	For 2 W input power at 115/230 VAC
Standby Output						
Standby Output Voltage	V_{SB}	4.75	5	5.25	V	± 5%
Standby Output Ripple Voltage	$V_{RIPPLE(SB)}$			50	mV	20 MHz bandwidth
Standby Output Current	$I_{OUT(SB)}$	1			A	
Main Converter Output						
Logic Output Voltage	V_{LG}	4.75	5	5.25	V	OVP _{MIN} : 115%, OVP _{MAX} : 140%
Logic Output Ripple	$V_{RIPPLE(LG)}$			50	mV	20 MHz bandwidth
Logic Output Current	I_{LG}	0	2	2	A	
Audio Output Voltage	V_{AU}	11	12	13	V	OVP _{MIN} : 115%, OVP _{MAX} : 140%
Audio Output Ripple	$V_{RIPPLE(AU)}$			120	mV	20 MHz bandwidth
Audio Output Current	I_{AU}	0	4	5	A	
Backlight Output Voltage	V_{BL}	22	24	26	V	OVP _{MIN} : 115%, OVP _{MAX} : 140%
Backlight Output Ripple	$V_{RIPPLE(BL)}$			200	mV	20 MHz bandwidth
Backlight Output Current	I_{BL}	0	7	9	A	
Total Output Power						
Continuous Output Power	P_{OUT}		225		W	Standby + Main
Peak Output Power	$P_{OUT(PK)}$			286	W	Standby + Main (thermally limited)
Efficiency						
Standby at Full Load	η_{SB}	85			%	Measured at 115 VAC
Total system at Full Load	η_{Main}	85			%	Measured at 90 VAC
		87				Measured at 115 VAC / 230 VAC
Environmental						
Conducted EMI						Meets CISPR22B / EN55022B
Safety						Designed to meet IEC950 / UL1950 Class II
Surge						1.2/50 μ s surge, IEC 1000-4-5,
Differential		2			kV	Differential Mode: 2 Ω
Common Mode		4			kV	Common Mode: 12 Ω
100 kHz Ring Wave		4			kV	500 A short circuit current
Ambient Temperature	T_{AMB}	0		50	°C	See thermal section for conditions



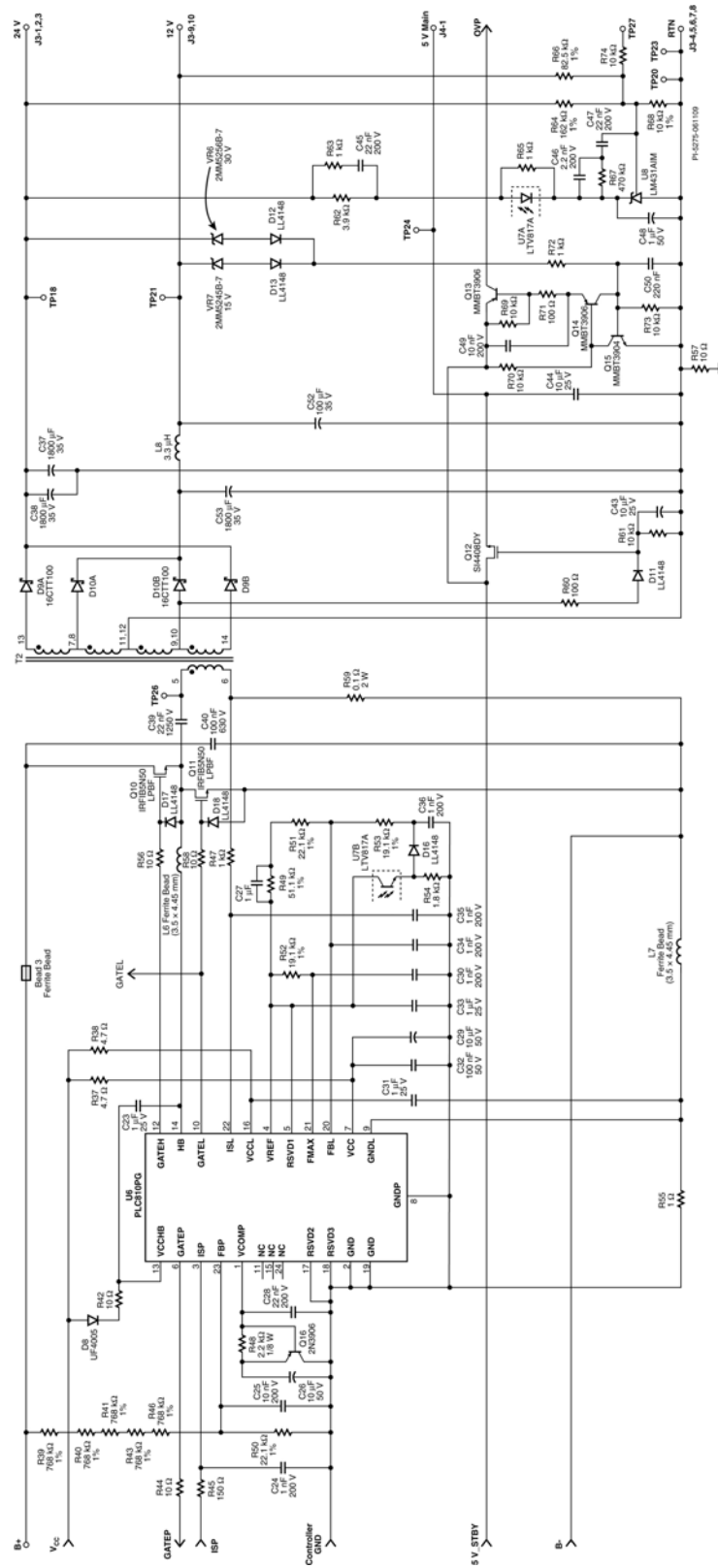

Figure 4 –Schematic of PLC810PG LCD TV Power Supply Application Circuit, PFC Circuit Control Inputs and LLC Stage.



4 Circuit Description

The main converter uses the PLC810PG in a primary-side-control, PFC + LLC configuration.

4.1 Input Filter / Boost Converter

The schematic in Figure 3 shows the input EMI filter and main PFC stage.

4.1.1 EMI Filtering

Capacitors C1 and C5 are connected directly across the pins of input receptacle J1 and are used to control common mode noise at frequencies greater than 30 MHz. A 5-turn ferrite bead inductor (L3) is used to connect the safety ground from J1 to chassis ground, providing damping at frequencies >30 MHz. Common mode inductors L1 and L2 control EMI at low frequencies and the mid-band (~10 MHz), respectively. Capacitors C2 and C6 control resonant peaks in the mid-band (~10 MHz) region.

PFC inductor L4 has a grounded shield band to prevent electrostatic and magnetic noise coupling to the EMI filter components. Capacitors C3 and C4 provide differential mode EMI filtering. To meet safety requirements resistors R1, R2 and R3 discharge these capacitors when AC is removed. The heat sink for PFC switch FET Q2 and PFC output diode D2 is tied to primary return at the cathode of D3 to eliminate the heat sink as a source of radiated noise.

4.1.2 Inrush limiting

Thermistor RT1 provides inrush limiting. It is shorted by relay RL1 during normal operation, gated by the power supply remote-on signal, increasing efficiency by approximately 1 - 1.5%.

4.1.3 Main PFC Stage

Components C9, C11, L4, Q2, and D2 form a continuous mode power factor correction circuit. Components Q1, Q3, R4, R9 and bead 2 buffer the PWM drive signal for Q2 from the PLC810 controller. Resistor R4 allows the turn-on speed and R7 the turn-off speed of Q2 to be adjusted to optimize the losses between D2 and Q2. In this design it was found that efficiency and EMI were both improved by reducing the value of R4 and R7 and adding ferrite beads to the gate and drain of Q2 (bead 2 and bead 1 respectively). In general, increasing MOSFET turn on drive current reduces MOSFET switching losses but increases the reverse recovery current through D2 and associated ringing. An ultra fast diode was selected for D2 as a lower cost alternative to a silicon carbide or other proprietary diode technology. These may provide higher efficiency by reducing reverse recovery charge, but significantly increase solution cost.

A 190 m Ω , 500 V power MOSFET was selected for Q2 to maximize the efficiency of the PFC stage.



Capacitor C10 provides local bypassing for the drive circuit. Current sensing for the PFC stage is provided by R6 and R8. The sense voltage is clamped to two diode drops by D3 and D4 protecting the current sense input of the controller IC during fault conditions. Diode D1 charges the PFC output capacitor (C11) when AC is first applied. This routes the inrush current around the PFC inductor L4 preventing it from saturating and causing stress in Q2 and D2 when the PFC stage begins to operate. Capacitor C11 is used to shrink the high frequency loop around components Q2, D2 and C9 to reduce EMI. The incoming AC is rectified by BR1 and filtered by C7. Capacitor C7 was selected as a low-loss polypropylene type due to its low loss and low impedance characteristics. This capacitor provides the high instantaneous current through L4 during Q2 on-time.

4.2 Main LLC Output

The Figure 4 schematic shows the LLC converter stage and the switched 5 V output, and the controller circuit.

4.2.1 LLC Input Stage

MOSFETs Q10 and Q11 are the switch MOSFETs for the LLC converter. They are driven directly by the controller IC via resistors R56 and R58. Capacitor C39 is the primary resonating capacitor, and should be a low-loss type rated for the RMS current at maximum load. Capacitor C40 is used for local bypassing, and is positioned adjacent to Q10 and Q11. Resistor R59 provides primary current sensing to the controller for overpower protection.

4.2.2 LLC Outputs

The secondaries of transformer T2 are rectified and filtered by D9-10, C37-38 and C53 to provide the +12 V and +24 V outputs. Inductor L8 and C52 provide additional filtering for the 12 V output, removing high frequency noise. Resistor R57 is connected between secondary return and chassis ground for high frequency EMI damping and to tie the secondary return to chassis ground. Capacitors C54 and C55 reduce the loop area for the 12 V and 24 V rectifier circuits.

4.2.3 Switched +5 V Output

MOSFET Q12 is used to switch the 5 V output of the standby supply to the +5 V logic output when the main converter is operating. The AC signal from one side of the 12 V output rectifier is used to turn on Q12 via R60, R61, D11, and C43. Capacitor C44 provides filtering of the 5 V logic output and is physically located near the output connection.

4.3 Controller

Figure 4 shows the circuitry around the main controller IC U6, which provides control functions for the input PFC and output LLC stages.

4.3.1 PFC Control

The PFC boost stage output voltage is fed back to the boost voltage sense pin (FBP of U13) via resistors R39-41, R43, R46, and R50. Capacitor C25 filters noise. Components



C26, C28 and R48 provide frequency compensation for the PFC. Transistor Q16 turns on during large signal excursions, bypassing C26. This allows fast slewing of the PFC control loop in response to a large load step. The PFC current sense signal from resistors R6 and R8 is filtered by R45 and C24. The PFC drive signal from the GATEP pin is routed to the main switching FET via R44. This damps any ringing in the PFC drive signal caused by the trace length from U6 to PFC switch MOSFET Q2.

4.3.2 Bypassing/Ground Isolation

Capacitors C29, C31, and C32 provide supply bypassing for the analog and digital supply rails for U6. Resistor R55 and ferrite bead L7 provide ground isolation between the PFC and LLC ground systems. Resistors R37 and R38 isolate the IC analog and digital supply rails. Ferrite bead L6 provides high frequency isolation between the LLC stage high side MOSFET drive return and the controller IC.

4.3.3 LLC Control

Feedback from the LLC output sense/feedback circuit is provided by U7, which develops a feedback voltage across resistor R54. Capacitor C36 filters the feedback signal. Resistors R49, R51, and R53 set the lower frequency limit for the LLC converter stage. Capacitor C27 is used to provide output soft start. Resistor R52 sets the LLC upper frequency limit. Capacitor C30 is a noise filter. The LLC overload sense signal from resistor R59 is filtered by R47 and C35. Components C23, R42, and D8 provide bootstrapping for the LLC top side MOSFET drive.

4.4 LLC Secondary Control Circuits

Figure 4 shows the secondary control schematic for the LLC stage.

4.4.1 Voltage Feedback

The LLC converter 12 V and 24 V outputs are sensed, weighted, and summed by resistors R64, R66, and R68. VR6, VR7 and D12, D13 sense any overvoltage condition in the 12 V or 24 V outputs. An overvoltage signal from either output is used to trigger a bipolar latch (Q14, Q15, R70, R73), which turns on transistor Q13. This transistor is used to deactivate the remote-on circuit (Figure 5), which turns off the primary bias, and hence the main controller IC.

4.5 5 V Standby/Primary Bias Supply/Remote Start

The schematic in Figure 5 shows the 5 V flyback standby and bias supply implemented using a TNY275PN. It provides +5 V for standby power and is switched to provide the 5 V output when the main converter is running. It also provides a primary referenced output used to supply the power for the PLC810PG controller IC. The schematic also shows the primary bias regulator, remote start, and brown-in/brown-out protection circuits.



4.5.1 5 V Flyback Supply

A TNY275PN (U4) is used in a single-ended Flyback supply to provide +5 V output and primary bias. Components VR1, R10, C12, and D5 clamp the primary leakage spike. This Zener-type clamp was selected over a RCD type for low standby power consumption. Resistor R11 sets the standby supply turn-on threshold to approximately 80 VAC. Components VR5, U2, R27, and R33 are used for overvoltage shutdown protection during an open loop fault condition. Components U3, R13, R17, R18, R23, C18 and C19 are the secondary output sensing and feedback components.

Capacitor C13 is used for local primary bypassing for the flyback converter. Resistor R12 provides sufficient bias to U4 to turn off its internal HV bias supply, reducing low load and no-load power consumption. Capacitor C42 reduces common mode EMI.

4.5.2 Primary Bias regulator/Remote Start

Components Q4, Q5, Q8, VR2, U1, C17, C51 R14, R16, R20, and SW1 constitute the bias regulator and remote on-off functions. Darlington transistor Q4, R14, and VR2 form a simple emitter-follower voltage regulator that is switched via optocoupler U1. Capacitor C17 limits the rate of rise of the bias voltage to avoid triggering the current limit of the standby supply. Components Q5, C51, and R20 quickly discharge C17 when optocoupler U1 is turned off.

Optocoupler U1 is turned on and off by Q8, SW1, R34, and R36. The supply can also be turned on by shorting test points TP5 and TP7.

4.5.3 Brownout Shutdown Circuit

A brownout shutdown circuit is provided. This circuit operates by sensing the AC input voltage and the presence of a switching signal from the LLC controller. When the power supply is operating, the absence of both of these signals, indicating insufficient AC input voltage and insufficient B+ voltage at the input to the LLC converter stage will cause the supply to shut down by switching off the primary bias regulator.

Components R24, R26, R28-30, C21, VR4, and Q7 are used to sense The AC input voltage. The voltage threshold of this circuit is set below the turn-on threshold of the standby/primary bias converter. Sufficient AC voltage triggers Q7, discharging capacitor C22, which is charged via R15. Resistor R25 provides some hysteresis to prevent chattering around the AC threshold voltage. Components R32, R35, and Q9 sense the switching drive from the lower output FET of the LLC converter. Transistor Q9 discharges capacitor C22 when the switching signal is present.

When the input voltage is sufficiently low, Q7 and Q9 turn off, allowing C22 to charge. Components Q6, R21, and VR3 sense the voltage at C22. When C22 has charged sufficiently, Q6 turns on, turning off the primary bias supply via Q4 and Q5, shutting down the PFC and LLC stages.



5 PCB Layout

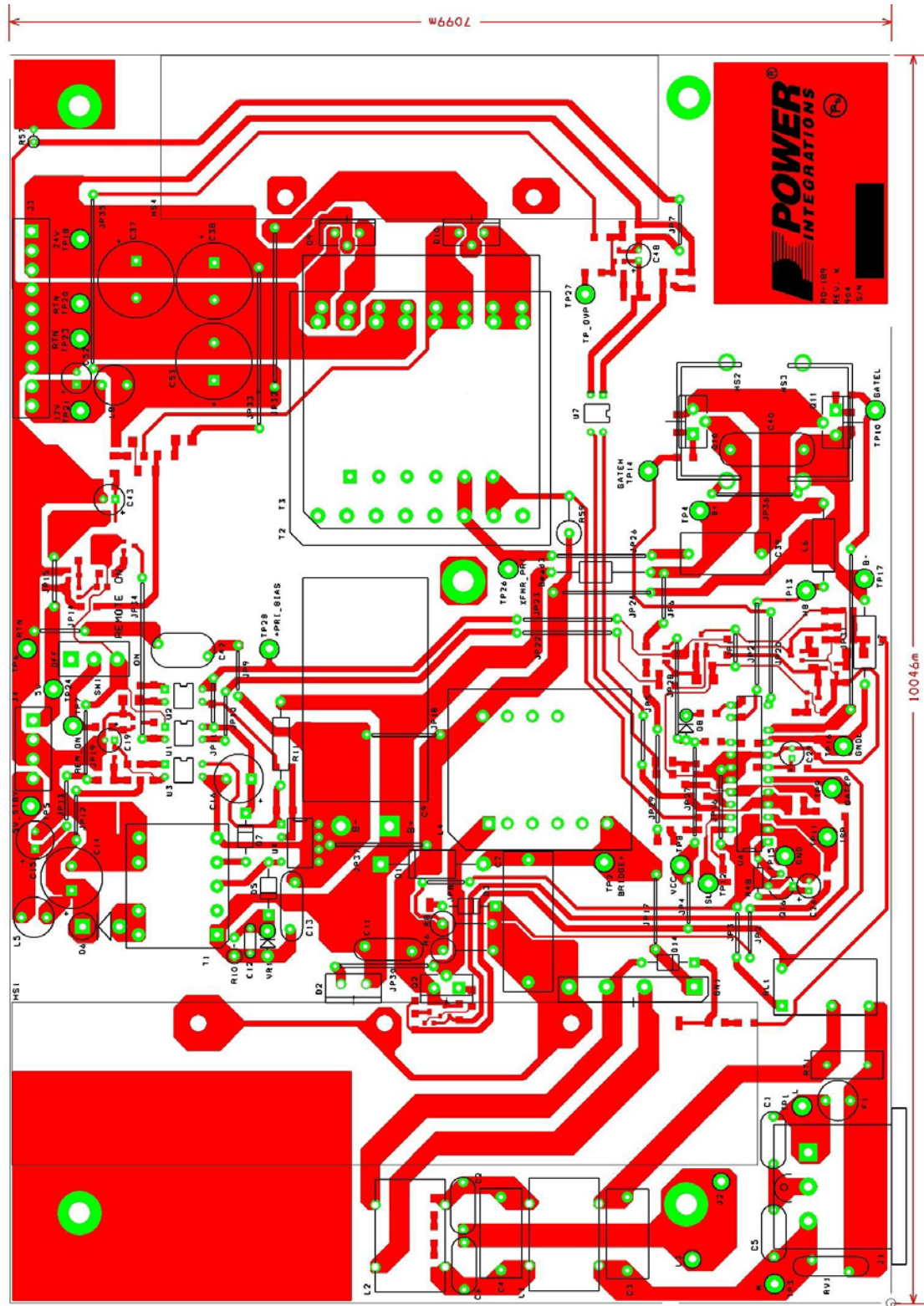

Figure 6 – Printed Circuit Layout, Top Side.



6 Bill of Materials

Item	Qty	Ref Des	Description	Mfg Part Number	Mfg
1	2	BEAD1 BEAD2	3.5 mm D x 3.25 L mm, 21 Ω at 25 MHz, 1.6mm (.063) hole, Ferrite Bead	2643001501	Fair-Rite
2	3	BEAD3 L6 L7	3.5 mm x 4.45 mm, 68 Ω at 100 MHz, 22 AWG hole, Ferrite Bead	2743001112	Fair-Rite
3	1	BR1	600 V, 8 A, Bridge Rectifier, GBJ Package	GBJ806-F	Diodes, Inc.
4	4	C1 C2 C5 C6	330 pF, Ceramic Y1	440LT33-R	Vishay
5	2	C3 C4	470 nF, 275 VAC, Film, X2	PX474K31D5	Carli
6	1	C7	1 μ F, 630 V, Polypropylene Film	ECW-F6105HL	Panasonic
7	1	C9	220 μ F, 450 V, Electrolytic, (25 x 45)	ECO-S2WP221CX	Panasonic
8	6	C10 C17 C23 C27 C31 C33	1 μ F, 25 V, Ceramic, X7R, 1206	ECJ-3YB1E105K	Panasonic
9	2	C11 C13	20 nF, 500 V, Disc Ceramic	D203Z59Z5UL63L0R	Vishay/BC
10	1	C12	1 nF, 1 kV, Disc Ceramic	DEBE33A102ZC1B	Murata
11	1	C14	2200 μ F, 10 V, Electrolytic, Very Low ESR, 21 m Ω , (12.5 x 20)	EKZE100ELL222MK20S	Nippon Chemi-Con
12	1	C15	220 μ F, 25 V, Electrolytic, Gen. Purpose, (8 x 11.5)	EKMG250ELL221MHB5D	Nippon Chemi-Con
13	1	C16	470 μ F, 35 V, Electrolytic, Low ESR, 52 m Ω , (10 x 20)	ELXZ350ELL471MJ20S	Nippon Chemi-Con
14	4	C18 C20 C22 C32	100 nF, 50 V, Ceramic, X7R, 1206	ECJ-3VB1H104K	Panasonic
15	4	C19 C26 C29 C43	10 μ F, 50 V, Electrolytic, Gen. Purpose, (5 x 11)	EKMG500ELL100ME11D	Nippon Chemi-Con
16	6	C21 C24 C30 C34 C35 C36	1 nF, 200 V, Ceramic, X7R, 0805	08052C102KAT2A	AVX
17	2	C25 C49	10 nF, 200 V, Ceramic, X7R, 0805	08052C103KAT2A	AVX
18	3	C28 C45 C47	22 nF, 200 V, Ceramic, X7R, 0805	08052C223KAT2A	AVX
19	3	C37 C38 C53	1800 μ F, 35 V, Electrolytic, Very Low ESR, 16 m Ω , (16 x 25)	EKZE350ELL182ML25S	Nippon Chemi-Con
20	1	C39	22 nF, 1250 V, Film	B32652A7223J	Epcos
21	1	C40	100 nF, 630 V, Film	ECQ-E6104KF	Panasonic
22	1	C42	1 nF, Ceramic, Y1	440LD10-R	Vishay
23	1	C44	10 μ F, 25 V, Ceramic, X5R, 1206	ECJ-3YB1E106M	Panasonic
24	1	C46	2.2 nF, 200 V, Ceramic, X7R, 0805	08052C222KAT2A	AVX
25	1	C48	1 μ F, 50 V, Electrolytic, Gen. Purpose, (5 x 11)	EKMG500ELL1R0ME11D	Nippon Chemi-Con
26	1	C50	220 nF, 25 V, Ceramic, X7R, 1206	ECJ-3VB1E224K	Panasonic
27	1	C51	100 pF, 200 V, Ceramic, COG, 0805	08052A101JAT2A	AVX
28	1	C52	100 μ F, 35 V, Electrolytic, Low ESR, 180 m Ω , (6.3 x 15)	ELXZ350ELL101MF15D	Nippon Chemi-Con
29	1	D1	600 V, 3 A, Rectifier, DO-201AD	1N5406	Vishay
30	1	D2	600 V, 8 A, Ultrafast Recovery, 12 ns, TO-220AC	STTH8S06D	ST Semiconductor
31	2	D3 D14	1000 V, 1 A, Rectifier, DO-41	1N4007-E3/54	Vishay



32	2	D4 D15	1000 V, 1 A, Rectifier, Glass Passivated, DO-213AA (MELF)	DL4007-13-F	Diodes Inc
33	1	D5	1000 V, 1 A, Ultrafast Recovery, 75 ns, DO-41	UF4007-E3	Vishay
34	1	D6	40 V, 5 A, Schottky, DO-201AD	SB540	Vishay
35	1	D7	200 V, 1 A, Ultrafast Recovery, 50 ns, DO-41	UF4003-E3	Vishay
36	1	D8	600 V, 1 A, Ultrafast Recovery, 75 ns, DO-41	UF4005-E3	Vishay
37	2	D9 D10	100 V, 16 A, Dual Schottky, TO-220AB	16CTT100	Vishay
38	6	D11 D12 D13 D16 D17 D18	75 V, 0.15 A, Fast Switching, 4 ns, MELF	LL4148-13	Diode Inc.
39	1	F1	5 A, 250 V, Slow, TR5	3721500041	Wickman
40	1	GREASE1	Thermal Grease, Silicone, 5 oz Tube	CT40-5	ITW Chemtronics
41	2	HS PAD1 HS PAD2	HEATSINK PAD, TO-220, Sil-Pad K10	K10-54	Bergquist
42	2	HS PAD3 HS PAD4	HEATSINK PAD, TO-220, Sil-Pad K10	K10-58	Bergquist
43	1	HS1	HEATSINK, Alum, EXT, 3 hole, 3 mtg holes, 6.00" L x 1.150" W x 1.300" H	62230U06000G,MOD	Aavid
44	2	HS2 HS3	HEATSINK, TWISTED FIN, 13.4°C/Watt, TO-220	593002B03400G	AavidThermalloy
45	1	HS4	HEATSINK, Alum, EXT, 2 hole, 2 mtg holes, 4.00" L x 1.150" W x 1.300" H	62230U04000G,MOD	Aavid
46	1	J1	AC Input Receptacle and Accessory Plug, PCBAM	161-R301SN13	Kobiconn
47	1	J3	10 Position (1 x 10) header, 0.156 pitch, Vertical	26-48-1105	Molex
48	1	J4	4 Position (1 x 4) header, 0.156 pitch, Vertical	26-48-1045	Molex
49	15	JP1 JP2 JP3 JP4 JP5 JP6 JP7 JP8 JP9 JP10 JP11 JP12 JP13 JP14 JP15	Wire Jumper, Non insulated, 22 AWG, 0.4 in	298	Alpha
50	5	JP16 JP17 JP18 JP19 JP36	Wire Jumper, Non insulated, 22 AWG, 0.6 in	298	Alpha
51	4	JP20 JP21 JP_C9+ JP_C9-	Wire Jumper, Non insulated, 22 AWG, 0.7 in	298	Alpha
52	9	JP22 JP23 JP24 JP26 JP27 JP28 JP29 JP30 JP37	Wire Jumper, Non insulated, 22 AWG, 0.8 in	298	Alpha
53	4	JP31 JP32 JP33 JP34	Wire Jumper, Non insulated, 22 AWG, 1.3 in	298	Alpha
54	1	JP35	Wire Jumper, Non insulated, 22 AWG, 1.4 in	298	Alpha
55	2	L1 L2	Common Mode Choke Toroidal, 10 mH	T22148-902S	Fontaine Tech CO. LTD
56	1	L3	29 μ H, Ground Choke, Flying Lead		
57	1	L4	PFC Choke, EE35/28, horizontal, 480 uH	SNX-R1493	Santronics



58	2	L5 L8	3.3 uH, 5.5 A	RL622-3R3K-RC	JW Miller
59	2	NUT1 NUT2	Nut, Hex, Kep 4-40, S ZN Cr3 plateing RoHS	4CKNTZR	Olander
60	1	Q1	NPN,60V 1000MA, SOT-23	FMMT491TA	Zetex Inc
61	1	Q2	560 V, 21 A, 190 mOhm. N-Channel, TO-220	SPP21N50C3IN	Infineon
62	1	Q3	PNP, 60V 1000MA, SOT-23	FMMT591TA	Zetex Inc
63	1	Q4	NPN, DARL 80V 500MA, SOT-89	BST52TA	Zetex Inc
64	3	Q5 Q13 Q14	PNP, Small Signal BJT, 40 V, 0.2 A, SOT-23	MMBT3906LT1G	On Semiconductor
65	5	Q6 Q7 Q8 Q9 Q15	NPN, Small Signal BJT, 40 V, 0.2 A, SOT-23	MMBT3904LT1G	On Semiconductor
66	2	Q10 Q11	500 V, 4.7 A, 670 mOhm. N-Channel, TO-220FP	IRFIB5N50LPBF	IR/Vishay
67	1	Q12	20 V, 14 A, 4.5 mOhm, N-Channel, SO-8	SI4408DY-T1-E3	Vishay
68	1	Q16	PNP, Small Signal BJT, 40 V, 0.2 A, TO-92	2N3906G	On Semiconductor
69	5	R1 R2 R3 R29 R30	680 k Ω , 5%, 1/4 W, Metal Film, 1206	ERJ-8GEYJ684V	Panasonic
70	1	R4	0 Ω , 5%, 1/4 W, Metal Film, 1206	ERJ-8GEY0R00V	Panasonic
71	2	R6 R8	0.11 Ω , 5%, 2 W, Metal Oxide	MO200J0R11B	Synton-Tech corporation
72	1	R7	2.2 Ω , 5%, 1/4 W, Metal Film, 1206	ERJ-8GEYJ2R2V	Panasonic
73	1	R9	4.7 k Ω , 5%, 1/4 W, Metal Film, 1206	ERJ-8GEYJ472V	Panasonic
74	1	R10	220 k Ω , 5%, 1/2 W, Carbon Film	CFR-50JB-220K	Yageo
75	1	R11	4.7 M Ω , 5%, 1/2 W, Carbon Film	CFR-50JB-4M7	Yageo
76	3	R12 R14 R16	22 k Ω , 5%, 1/4 W, Metal Film, 1206	ERJ-8GEYJ223V	Panasonic
77	2	R13 R22	470 Ω , 5%, 1/4 W, Metal Film, 1206	ERJ-8GEYJ471V	Panasonic
78	1	R15	330 k Ω , 5%, 1/4 W, Metal Film, 1206	ERJ-8GEYJ334V	Panasonic
79	7	R17 R33 R36 R47 R63 R65 R72	1 k Ω , 5%, 1/4 W, Metal Film, 1206	ERJ-8GEYJ102V	Panasonic
80	1	R18	10.2 k Ω , 1%, 1/4 W, Metal Film, 1206	ERJ-8ENF1022V	Panasonic
81	1	R19	1.3 M Ω , 5%, 1/4 W, Metal Film, 1206	ERJ-8GEYJ135V	Panasonic
82	1	R20	220 k Ω , 5%, 1/4 W, Metal Film, 1206	ERJ-8GEYJ224V	Panasonic
83	2	R21 R26	100 k Ω , 5%, 1/4 W, Metal Film, 1206	ERJ-8GEYJ104V	Panasonic
84	2	R23 R68	10.0 k Ω , 1%, 1/4 W, Metal Film, 1206	ERJ-8ENF1002V	Panasonic
85	1	R24	226 k Ω , 1%, 1/4 W, Metal Film, 1206	ERJ-8ENF2263V	Panasonic
86	1	R25	3.9 M Ω , 5%, 1/4 W, Metal Film, 1206	ERJ-8GEYJ395V	Panasonic
87	1	R27	33 Ω , 5%, 1/4 W, Metal Film, 1206	ERJ-8GEYJ330V	Panasonic
88	1	R28	620 k Ω , 5%, 1/4 W, Metal Film, 1206	ERJ-8GEYJ624V	Panasonic
89	1	R31	2.2 k Ω , 5%, 1/4 W, Metal Film, 1206	ERJ-8GEYJ222V	Panasonic
90	7	R32 R35 R61 R69 R70 R73 R74	10 k Ω , 5%, 1/4 W, Metal Film, 1206	ERJ-8GEYJ103V	Panasonic
91	2	R34 R62	3.9 k Ω , 5%, 1/4 W, Metal Film, 1206	ERJ-8GEYJ392V	Panasonic
92	2	R37 R38	4.7 Ω , 5%, 1/4 W, Metal Film, 1206	ERJ-8GEYJ4R7V	Panasonic
93	5	R39 R40	768 k Ω , 1%, 1/4 W, Metal Film, 1206	ERJ-8ENF7683V	Panasonic



		R41 R43 R46			
94	4	R42 R44 R56 R58	10 Ω , 5%, 1/4 W, Metal Film, 1206	ERJ-8GEYJ100V	Panasonic
95	1	R45	150 Ω , 5%, 1/4 W, Metal Film, 1206	ERJ-8GEYJ151V	Panasonic
96	1	R48	2.2 k Ω , 5%, 1/8 W, Carbon Film	CFR-12JB-2K2	Yageo
97	1	R49	51.1 k Ω , 1%, 1/4 W, Metal Film, 1206	ERJ-8ENF5112V	Panasonic
98	2	R50 R51	22.1 k Ω , 1%, 1/4 W, Metal Film, 1206	ERJ-8ENF2212V	Panasonic
99	2	R52 R53	19.1 k Ω , 1%, 1/4 W, Metal Film, 1206	ERJ-8ENF1912V	Panasonic
100	1	R54	1.8 k Ω , 5%, 1/4 W, Metal Film, 1206	ERJ-8GEYJ182V	Panasonic
101	1	R55	1 Ω , 5%, 1/4 W, Metal Film, 1206	ERJ-8GEYJ1R0V	Panasonic
102	1	R57	10 Ω , 5%, 1/4 W, Carbon Film	CFR-25JB-10R	Yageo
103	1	R59	0.1 Ω , 5%, 2 W, Metal Oxide	MO200J0R1B	Synton-Tech Corporation
104	1	R60	100 Ω , 5%, 1/4 W, Metal Film, 1206	ERJ-8GEYJ101V	Panasonic
105	1	R64	162 k Ω , 1%, 1/4 W, Metal Film, 1206	ERJ-8ENF1623V	Panasonic
106	1	R66	82.5 k Ω , 1%, 1/4 W, Metal Film, 1206	ERJ-8ENF8252V	Panasonic
107	1	R67	470 k Ω , 5%, 1/4 W, Metal Film, 1206	ERJ-8GEYJ474V	Panasonic
108	1	R71	100 Ω , 1%, 1/4 W, Metal Film, 1206	ERJ-8ENF1000V	Panasonic
109	1	RL1	SPST-NO, 5A 12VDC, PC MNT	G6B-1114P-US-DC12	OMRON
110	1	RT1	NTC Thermistor, 5 Ohms, 4.7 A	CL150	Thermometrics
111	1	RV1	320V, 84J, 15.5 mm, RADIAL	S14K320	Epcos
112	5	SCREW1 SCREW2 SCREW3 SCREW4 SCREW21	SCREW MACHINE PHIL 6-32X5/16 SS	PMSSS 632 0031 PH	Building Fasteners
113	12	SCREW5 SCREW6 SCREW7 SCREW8 SCREW9 SCREW10 SCREW11 SCREW12 SCREW13 SCREW14 SCREW15 SCREW16	SCREW MACHINE PHIL 4-40X5/16 SS	PMSSS 440 0031 PH	Building Fasteners
114	5	STDOFF1 STDOFF2 STDOFF3 STDOFF4 STDOFF5	Standoff Hex,6-32, .375L,Alum	2209	Keystone Elect
115	1	SW1	SLIDE MINI SPDT PC MNT AU	1101M2S3CBE2	ITT Ind/C&Kdiv
116	1	T1	Transformer, 5V Stby/Bias, EE25, Vertical, 9 pins	SNX-R1495	Santronics
117	1	T2	Transformer, LLC, 12/24V, EX4841, Horizontal, 14 pins	SRX48EM-P241200H8701	TDK
118	22	TP1 TP2 TP3 TP4 TP5 TP6 TP7 TP9 TP10 TP11 TP12 TP13 TP14 TP15	Test Point, BLK,THRU-HOLE MOUNT	5011	Keystone



		TP16 TP17 TP18 TP20 TP21 TP23 TP24 TP26			
119	1	TP8	Test Point, YEL, THRU-HOLE MOUNT	5014	Keystone
120	1	TP27	Test Point, RED, THRU-HOLE MOUNT	5010	Keystone
121	1	TP28	Test Point, ORG, THRU-HOLE MOUNT	5013	Keystone
122	3	U1 U2 U7	Optocoupler, 35 V, CTR 80-160%, 4-DIP	LTV-817A	Liteon
123	1	U3	Optocoupler, 80 V, CTR 300-600%, 4-DIP	PC817X4J000F	Sharp
124	1	U4	TinySwitch-III, TNY275PN, DIP-8C	TNY275PN	Power Integrations
125	2	U5 U8	IC, REG ZENER SHUNT ADJ SOT-23	LM431AIM3/NOPB	National Semiconductor
126	1	U6	Controller, PFC/LLC, 24-pin DIP	PLC810PG	Power Integrations
127	1	VR1	150 V, 5 W, 5%, TVS, DO204AC (DO-15)	P6KE150A	LittleFuse
128	2	VR2 VR7	15 V, 5%, 500 mW, DO-213AA (MELF)	ZMM5245B-7	Diodes Inc
129	1	VR3	5.6 V, 5%, 500 mW, DO-213AA (MELF)	ZMM5232B-7	Diodes Inc
130	1	VR4	10 V, 5%, 500 mW, DO-213AA (MELF)	ZMM5240B-7	Diodes Inc
131	1	VR5	5.1 V, 5%, 500 mW, DO-213AA (MELF)	ZMM5231B-7	Diodes Inc
132	1	VR6	30 V, 5%, 500 mW, DO-213AA (MELF)	ZMM5256B-7	Diodes Inc
133	5	WASHER1 WASHER2 WASHER3 WASHER4 WASHER18	Washer Flat #6, SS	FWSS 006	Building Fasteners
134	12	WASHER5 WASHER6 WASHER7 WASHER8 WASHER9 WASHER10 WASHER11 WASHER12 WASHER13 WASHER14 WASHER15 WASHER16	WASHER FLAT #4 SS	FWSS 004	Building Fasteners
135	2	WASHER17 WASHER18	Washer Nylon Shoulder #4	3053	Keystone
136	2	WASHER19 WASHER20	Washer Nylon Shoulder #4	3049	Keystone
137	1		Printed Circuit board, RD189, Rev. K		



7 Magnetics

7.1 Main LLC 12/24 V Transformer (T2) Specification

7.1.1 Electrical Diagram

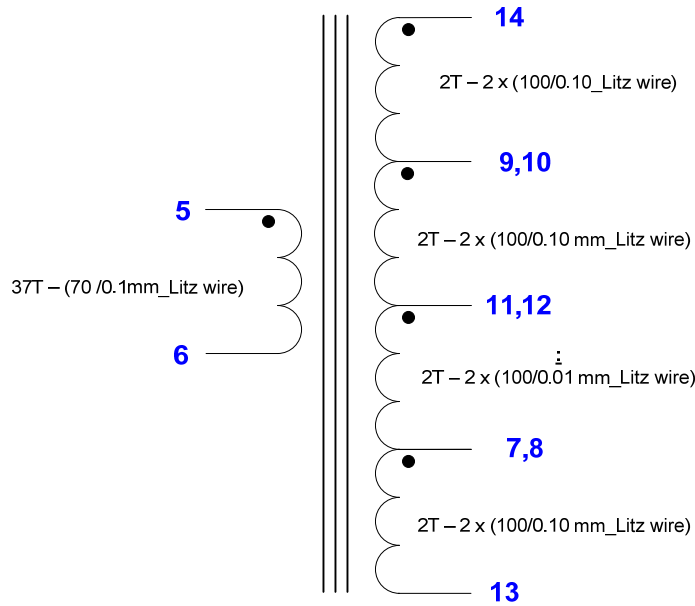

Figure 8 – Transformer Electrical Diagram.

7.1.2 Electrical Specifications

Electrical Strength	60 second, 60 Hz, from pins 1-6 to pins 7-14	3000 VAC
Primary Inductance	Pins 5-6, all other windings open, measured at 100 kHz, 0.4 VRMS	350 μ H \pm 10%
Resonant Frequency	Pins 5-6, all other windings open	1000 kHz (Min.)
Primary Leakage Inductance	Pins 5-6, with pins 7-14 shorted, measured at 100 kHz, 0.4 VRMS	100 μ H \pm 10%



7.2 5V Standby Supply Transformer (T1) Specification)

7.2.1 Electrical Diagram

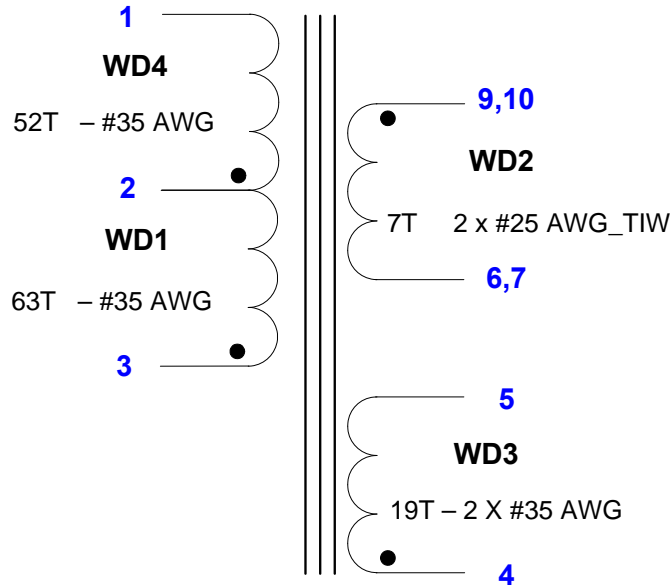

Figure 9 – Standby Transformer Schematic.

7.2.2 Electrical Specifications

Electrical Strength	1 second, 60Hz, from pins 1-5 to pins 6-10	3000 VAC
Primary Inductance	Pins 1-3, all other winding open, measured at 100 kHz, 0.4 VRMS	4.41 mH, $\pm 10\%$
Resonant Frequency	Pins 1-3, all other winding open	800 kHz (min)
Primary Leakage Inductance	Pins 1-3, with pins 6-10 shorted, measured at 100 kHz, 0.4 VRMS	45 μ H (max)

7.2.3 Materials

Item	Description
[1]	Core Pair: EE25, Nippon Ceramic NC-2H or equivalent, gapped for A_L of 333 nH/T ² .
[2]	Bobbin: EE25, Phenolic, Vertical, 10 pins, (5/5), Yih Hwa YW360-02B or equivalent.
[3]	Magnet Wire: #35 AWG, solderable double coated.
[4]	Triple Insulated Wire: #25 AWG, Furukawa Tex-E or equivalent.
[5]	Tape: Polyester Film 3M 1350F-1 or equivalent, 10.6 mm wide.
[6]	Transformer Varnish, Dolph, BC-359-MS or equivalent.



7.2.4 Build Diagram

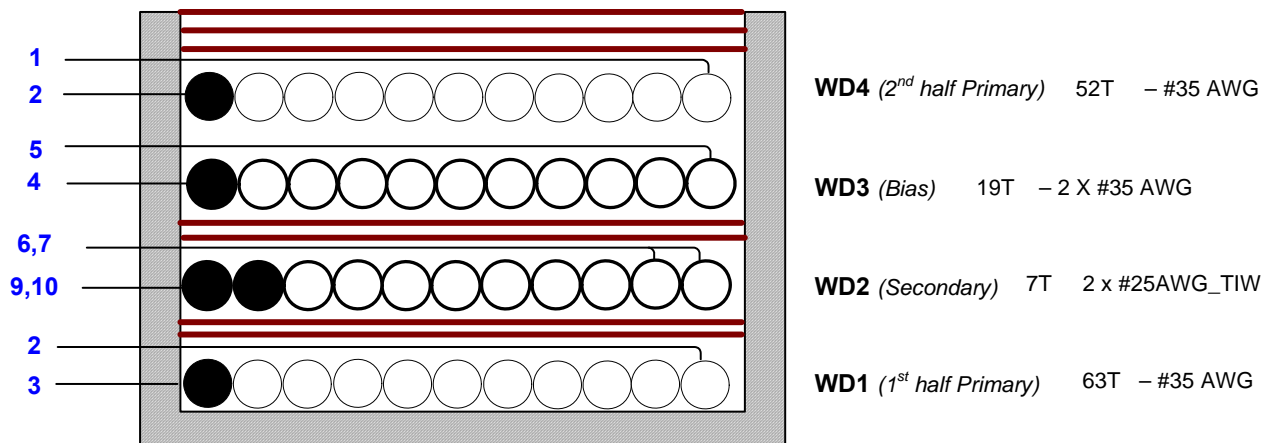

Figure 10 – Standby Transformer Build Diagram.

7.2.5 Construction

Winding/Bobbin preparation	Orient bobbin (item [2]) on winding machine such that the pin side of bobbin is on the left side. Remove pin 8.
WD1 (1st half Primary)	Starting at pin 3, wind 63 turns of wire (item [3]) in one layer from left to right. After the last turn, place ½” piece of tape (item [7]) on winding to insulate the crossover, and bring the wire back to the left side to terminate at pin 2.
Insulation	Apply two layers of tape (item [5]).
WD2 (Secondary)	Starting at pins 9 and 10, wind 7 bifilar turns of triple insulated wire (item [4]) in one layer, from left to right, finishing at pins 6&7.
Insulation	Apply two layers of tape (item [5]).
WD3 (Bias)	Starting at pin 4, wind 19 bifilar turns of wire (item [3]) in one layer from left to right, spreading turns evenly across the bobbin, finishing at pin 5.
Insulation	Apply one layer of tape (item [5]).
WD4 (2nd half Primary)	Starting at pin 2, wind 52 turns of wire (item [3]) from left to right in one layer, spreading the turns evenly across the bobbin. After the last turn, use ½” of tape (item [5]) to insulate finish lead crossover, and finish at pin 1.
Insulation	Apply 3 layers of tape (item [5]) as finish wrap.
Finish	Gap core halves (item [1]) for inductance of 4.41 mH ±10%. Assemble and secure core halves. Dip varnish using (item [6]).

7.3 PFC Choke (L4) Specification

7.3.1 Electrical Diagram

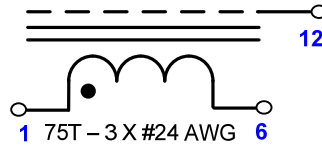

Figure 11 – PFC Choke Schematic.

7.3.2 Electrical Specification

Inductance: 480 μ H \pm 15%

Note – Do not measure inductance without copper strap (shield) in place!

7.3.3 Materials

Item	Description
[1]	E Core Pair: Sendust, 60μ, EE35/28 Chang Sung S060 EE35/28 or equivalent.
[2]	Bobbin, E375, Horizontal, 12 pin, Ferroxcube CPH-E34/14/9-1S-12PD-Z or equivalent.
[3]	Magnet wire: #24 AWG, solderable double coated.
[4]	Tape polyester film, 3M 1350F-1 or equivalent, 17 mm wide.
[5]	Tape polyester film, 3M 1350F-1 or equivalent, 9 mm wide.
[6]	Tape, copper foil, 3M 1125 or equivalent, 12.5 mm wide.
[7]	Wire, tinned bus, #24 AWG.

7.3.4 Build Diagram

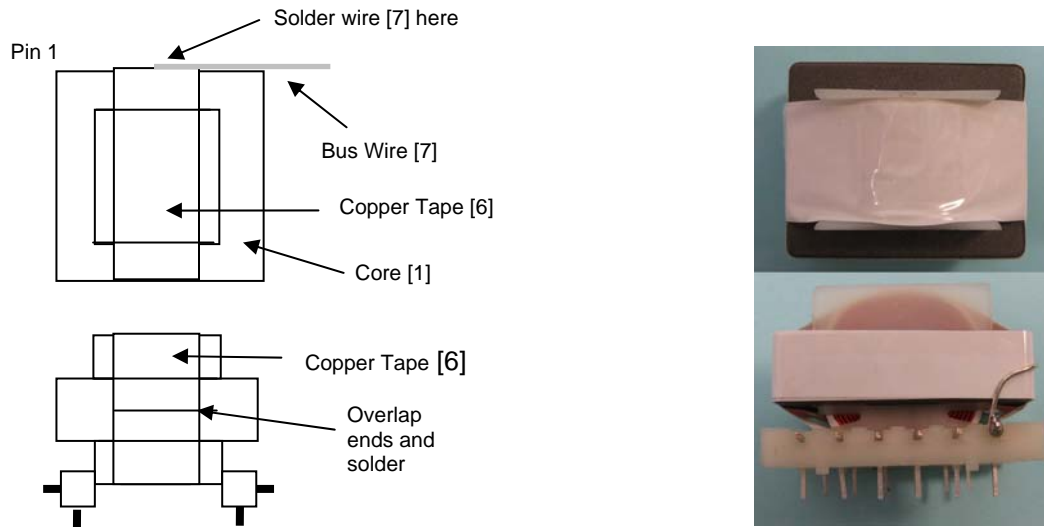

Figure 12 – PFC Choke Build Diagram.



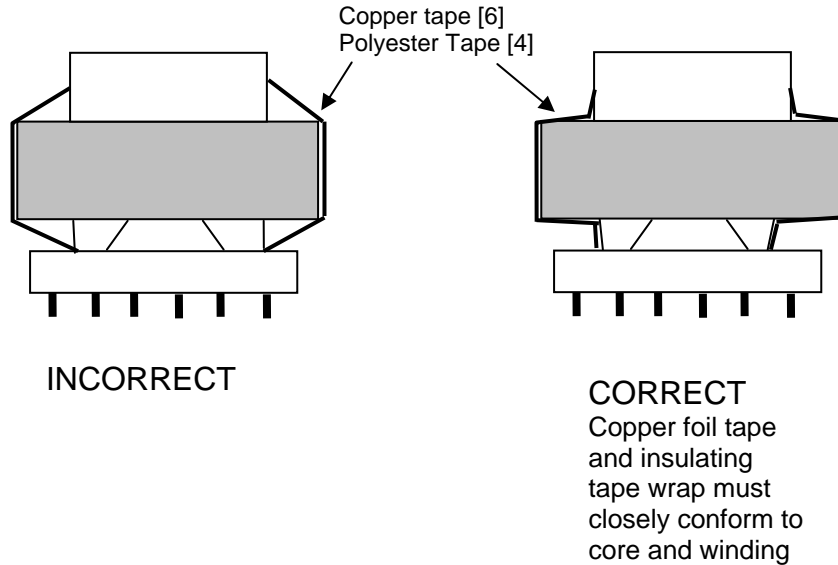

Figure 13 – Instructions for Applying Hum Strap.

7.3.5 Winding Instructions

Winding	Starting on pin 1, wind 75 trifilar turns of wire (item [3]) on bobbin (Item [2]). Finish on pin 6.
Finish Wrap	Use 3 layers of tape (Item [4]) for finish wrap.
Assembly	Assemble bobbin and core halves. Secure core with two wraps of tape (Item 5).
Hum Strap, Ground Wire	Apply 1 turn of copper tape (Item [6]) as shown in Figure 1, centered in bobbin window. Conform tape to contours of core and winding (Figure 15). Overlap start and finish ends as shown in Figure 15, and solder to form a shorted turn. Take 3cm of hook-up wire (item [7]), solder 1 end of wire to copper foil as shown in Figure 1. Terminate other end on pin 12 of bobbin.
Hum Strap Insulation	Apply 3 turns of tape (item [4]) to insulate copper strap.
Varnish, Pin Removal	Vacuum impregnate finished assembly, cut off pins 7-8.

7.4 Ground Choke (L3) Specification

7.4.1 Schematic Diagram



Inductance: $27\mu\text{H} \pm 25\%$

Figure 14 – Ground Choke Schematic.

7.4.2 Materials

Item	Description
[1]	Core, Ferrite, Fair-Rite 2643006302 or equivalent.
[2]	Hookup Wire: UL1007 #22 AWG, Grn/Yel, Alpha 3051 GY or equivalent.

7.4.3 Winding Instructions

Winding	Wind 5 turns of wire (item [2]) on core (Item [1]). Trim start and finish. Leads to $\frac{3}{4}$ ".
Lead Preparation	Strip start and finish $\frac{1}{4}$ ".
Lead Tinning	Dip-tin stripped wire ends to prevent fraying.



8 LLC Transformer Spreadsheet

ACDC_PLC810_121908; Rev.1.1; Copyright Power Integrations 2008	INPUTS	INFO	OUTPUTS	UNITS	ACDC_PLC810_121908_Rev1-1.xls; PLC810 Half-Bridge, Continuous mode LLC Resonant Converter Design Spreadsheet
Enter Input Parameters					Design Title
Vacmin	90.00		90	V	Minimum AC input voltage
Vacmax			265	V	Maximum AC input voltage
Iacimmax			3.78	A	Maximum input AC rms current at Vacmin
Vbulk			385.00	V	Nominal PFC output voltage
Vbulkmax			411.95	V	Peak PFC OVP voltage (typical is 7% above Vbulk)
Vbulkmin			250.25	V	Minimum bulk capacitor voltage at the specified holdup time. Typical value is between 250 - 320 VDC. Max holdup time is at 250 V
fL			50.00	Hz	AC Line input frequency
Holdup time			20.00	ms	Bulk capacitor hold up time
CIN_MIN			146.42	uF	Minimum value of bulk cap to meet holdup time requirement; Adjust holdup time and Vbulkmin to change bulk cap value
bulk ripple			10.79	V	Bulk capacitor peak to peak voltage (low freq ripple)
Vrippeak			390.40	V	Bulk cap peak value of ripple voltage
IAC			3.78	A	AC input rms current at VACMIN
IAC_PEAK			5.35	A	Peak AC input current at full load and VACMIN
Enter LLC (secondary) outputs					The spreadsheet assumes AC stacking of the secondaries
Vo1	24.00			V	Main Output Voltage. Spreadsheet assumes that this is the regulated output
Io1	9.00			A	Main output maximum current
Vd1			0.70	V	Forward voltage of diode in main output
Po1			216.00	W	Output Power from first LLC output
Vo2	12.00			V	Second Output Voltage
Io2	5.00			A	Second output current
Vd2	0.70		0.70	V	Forward voltage of diode used in second output
Po2			60.00	W	Output Power from second LLC output
Enter stand-by (auxiliary) outputs					
Vo3	5.00			V	Auxiliary Output 1 Voltage
Io3	2.00			A	Auxiliary Output 1 maximum current
Vo4				V	Auxiliary Output 2 Voltage
Io4				A	Auxiliary Output 2 maximum current
Efficiency and Loss Allocation					
P_LL			276.00	W	Specified LLC output power
P_AUX			10.00	W	Auxiliary output power
P_PFC			313.33	W	PFC output power
P_TOTAL			286.00	W	Total output power (Includes Output power from LLC stage and auxiliary stage)
LLC_n_estimated			0.92		Efficiency of LLC stage



AUX_n_estimated		0.75		Efficiency of auxiliary output
PFC_n_estimated		0.92		Minimum efficiency of PFC front end stage
PIN		340.58	W	AC input power
Overall efficiency		0.84		Minimum system efficiency
Ploss_PFC		27.25	W	PFC stage power loss
Ploss_LLC		24.00	W	LLC stage power loss
Ploss_AUX		3.33	W	Auxiliary power loss
Ploss_TOTAL		54.58	W	Total power loss
Enter PFC Design Parameters				
f_nominal_desired		100.00	kHz	Desired full load switching frequency. Recommended value 66 kHz to 132 kHz
Krp	0.33	0.33		PFC choke ripple current factor. Actual Krp tends to increase at higher current when using iron powder/Sendust cores, due to drop in inductance at higher current
Diode bridge Vf		0.70	V	Forward voltage drop of diode bridge
Rdson		0.19	ohms	PFC MOSFET Rdson - use high temp value from datasheet
Coss		21.45	pF	PFC MOSFET high voltage Coss from datasheet
tON		20.00	ns	MOSFET turnon current rise time. Check actual value
Qrr		52.22	nC	Average Qrr of boost diode over AC sinusoid
PFC CHOKE Parameters				
Lpfc		482.47	uH	PFC choke inductance
ILpk		7.12	A	PFC choke peak current at VACMIN
AL	86.00		nH/t ²	nH per turn ² (from magnetics datasheet). Note - This value decreases by as much as 15% if a belly-band is added to reduce EMI
n		74.90	turns	PFC choke number of turns
MLT	5.00		cm	Mean length per turn
AWG_Choke	24			PFC choke wire gauge
Equivalent Choke Metric Wire gauge		0.55	mm	Equivalent diameter of wire in metric units
Wire length		3.75	m	Length of wire used on PFC choke
Strands	3			Number of wires
DCR		113.96	m-ohms	DC resistance of wire at 25 C
DCR at 85 C		143.58	m-ohms	DC resistance of wire at 85 C
Irms_CHOKE		3.97	A	PFC choke rms current
DCR Cu loss		2.26	W	PFC choke DC Copper loss for reference at 85 C
ACR_PFC_Choke		287.17	m-ohms	Measure or calculate; add 26% to measured value to get 85 C value
HF Irms		0.62	A	RMS current of switching component
HF Cu loss		0.11	W	Copper loss due to switching component at 85 C
tot Cu loss		2.38	W	Total copper loss at 85 C
LM	6.82		cm	Magnetic path length of core used
Hpk		98.22	Oe	Peak MMF in Oersteds, calculated at low line
Hpk_SI		7820	A/m	Peak MMF in A/m, calculated at low line
PFC FET, Diode and Output Parameters				
Isense_R		0.06	ohms	Maximum value of PFC current sense resistor



Sense resistor power dissipation	0.95	W	PFC sense resistor power dissipation at Vacmin
Irms_FET	3.42	A	PFC MOSFET RMS current measured at VACMIN
Conduction loss	2.18	W	PFC MOSFET conduction loss
Trrloss	1.99	W	PFC MOSFET loss due to diode Trr
Cossloss	0.15	W	MOSFET Coss loss
Crossover loss	1.74	W	MOSFET crossover turnon loss
Total PFC loss	5.91	W	MOSPFC FET total loss
Diode bridge Ploss	4.79	W	Diode bridge estimated loss
PFC Diode RMS current	1.47	A	Approximate PFC Diode RMS current at nominal AC input voltage (VACMIN) (includes 100/120 Hz component)
Bulk capacitor RMS current	1.62	A	Approximate Bulk Capacitor RMS current at nominal AC input voltage (VACMIN) (includes 100/120 Hz component and LLC input current)
LLC TRANSFORMER CALCULATIONS			
Po	285.80	W	Output from LLC converter including diode loss
Vo	24.70	V	Output at transformer windings (includes diode drop)
Ae	1.30	cm ²	Transformer core cross-sectional area
Lpar	255.00	uH	Parallel inductance. (Lpar = Lopen - Lser for integrated transformer; Lpar = Lmag for non-integrated transformer)
Lser	95.00	uH	Leakage inductance of integrated transformer; Leakage + external inductor for non-integrated transformer
Lopen	350.00	uH	Primary open circuit inductance for integrated transformer
C	22.00	nF	Series resonant capacitor
fnominal_desired	100.00	kHz	Desired full load switching frequency. Recommended value 66 kHz to 132 kHz
fnominal_actual	98.8	kHz	Expected frequency at nominal input voltage (VBULK) and full load
IRMS_LLC_Primary	1.92	A	Primary winding RMS current at full load and nominal input voltage (VBULK)
IRMS_LLC_Q1	1.36	A	RMS current through upper MOSFET in LLC half bridge
VMIN	273.8	V	Minimum Voltage on Bulk Capacitor at minimum switching frequency
f_AT_VMIN	65.00	kHz	Frequency at minimum Bulk capacitor voltage
fpar	67	kHz	Parallel resonant frequency (defined by Lpar + Lser and C)
fser	110	kHz	Series resonant frequency (defined by series inductance Lser and C)
fmin	67	kHz	Min frequency, at VBULK_MIN and full load. Set PLC810 minimum frequency to this value. Operation below this frequency results in loss of ZVS
NP_1	34		Primary winding number of turns
NS_1	4.00		Secondary winding number of turns
n_RATIO	8.50		Transformer turns ratio. Adjust this value to operate close to VBULK at 100 kHz
Bpkfmin	1782	Gauss	First Quadrant peak flux excursion at minimum frequency.
BAC	2405	Gauss	AC peak to peak flux density (calculated at fnominal_actual, VBULK at full load)
LLC sense resistor	0.11	ohms	LLC current sense resistor
Pdiss_LLC_senseR	0.39	W	Power dissipation in LLC sense resistor



PRIMARY				
Primary gauge	38.00		AWG	Individual wire strand gauge used for primary winding
Equivalent Primary Metric Wire gauge		0.10	mm	Equivalent diameter of wire in metric units
Primary litz strands	70.00			Number of strands used in Litz wire; for non-litz non-integrated transformer set to 1
Primary parallel wires	1.00			Number of parallel individual wires to make up Litz wire
Resistivity_25 C_Primary		33.50	m-ohm/m	Resistivity in milli-ohms per meter
Transformer primary MLT	7.00		cm	Mean length per turn
Primary turns		34.00		Number of primary turns
Primary DCR 25 C		79.74	m-ohm	Estimated resistance at 25 C
Primary DCR 100 C		106.85	m-ohm	Estimated resistance at 100 C (approximately 33% higher than at 25 C)
Primary RMS current	1.50		A	Measured RMS current through the primary winding
ACR_Trif_Primary		170.96	m-ohm	Measured AC resistance (at 100 kHz, room temperature), multiply by 1.33 to approximate 100 C winding temperature
Primary copper loss		0.38	W	Total primary winding copper loss at 85 C

Separate Series Inductor (For non-integrated transformer only)				
Lsep		95.00	uH	Desired inductance from separate inductor
Ae_Ind	0.53		cm^2	Inductor core cross-sectional area
Inductor turns	25.00	25		Number of primary turns
BP_fnom		2086	Gauss	AC flux for core loss calculations (at fnom and full load)
BP_fmin		2575	Gauss	Peak flux density, calculated at minimum frequency fmin
Inductor gauge	36.00		AWG	Individual wire strand gauge used for primary winding
Equivalent Inductor Metric Wire gauge		0.13	mm	Equivalent diameter of wire in metric units
Inductor litz strands	60.00			Number of strands used in Litz wire
Inductor parallel wires	1.00			Number of parallel individual wires to make up Litz wire
Resistivity_25 C_Sep_Ind		24.58	m-ohm/m	Resistivity in milli-ohms per meter
Inductor MLT	7.00		cm	Mean length per turn
Inductor DCR 25 C		43.02	m-ohm	Estimated resistance at 25 C (for reference)
Inductor DCR 100 C		57.65	m-ohm	Estimated resistance at 100 C (approximately 33% higher than at 25 C)
ACR_Sep_Inductor		92.24	m-ohm	Measured AC resistance (at 100 kHz, room temperature), multiply by 1.33 to approximate 100 C winding temperature
Inductor copper loss		0.21	W	Total primary winding copper loss at 85 C

Secondary 1 (Vo1)				
Sec 1 Wire gauge	38		AWG	Note - Power loss calculations are for each winding half of secondary Individual wire strand gauge used for secondary winding
Equivalent secondary 1 Metric Wire gauge		0.10	mm	Equivalent diameter of wire in metric units
Sec 1 litz strands	100			Number of strands used in Litz wire; for non-litz non-integrated transformer set to 1
Parallel wires sec 1	1			Number of parallel individual wires to make up



				Litz wire
Resistivity_25 C_sec1 Transformer Secondary MLT	7.00	23.45	m-ohm/m	Resistivity in milli-ohms per meter
Sec 1 Turns		4.00	cm	Mean length per turn
DCR_25C_Sec1		3.28	m-ohm	Secondary winding turns (each half)
DCR_100C_Sec1		4.40	m-ohm	Estimated resistance at 25 C (for reference) Estimated resistance at 100 C (approximately 33% higher than at 25 C)
Sec 1 RMS current		14.15	A	RMS current through Output 1 winding, assuming half sinusoidal waveshape
DCR_Ploss_Sec1		0.71	W	Estimated Power loss due to DC resistance (both secondary halves)
ACR_Sec1		7.04	m-ohm	Measured AC resistance (at 100 kHz, room temperature), multiply by 1.33 to approximate 100 C winding temperature . Default value of ACR is twice the DCR value at 100 C
ACR_Ploss_Sec1 Total secondary winding Copper Losses		2.82	W	Estimated AC copper loss (both secondary halves)
		2.82	W	Total (AC + DC) winding copper loss for both secondary halves

Secondary 2 (Vo2)				Note - Power loss calculations are for each winding half of secondary
Sec 2 Wire gauge Equivalent secondary 2 Metric Wire gauge	38		AWG	Individual wire strand gauge used for secondary winding
		0.10	mm	Equivalent diameter of wire in metric units
Sec 2 litz strands	100			Number of strands used in Litz wire; for non-litz non-integrated transformer set to 1
Parallel wires sec 2	2			Number of parallel individual wires to make up Litz wire
Resistivity_25 C_sec2 Transformer Secondary 2 MLT	7.00	11.73	m-ohm/m	Resistivity in milli-ohms per meter
Sec 2 Turns	2.00		cm	Mean length per turn
DCR_25C_Sec2		1.64	m-ohm	Secondary winding turns (each half)
DCR_100C_Sec2		2.20	m-ohm	Estimated resistance at 25 C (for reference)
Sec 2 RMS current		22.01	Arms	Estimated resistance at 100 C for half secondary (approximately 33% higher than at 25 C) RMS current through Output 2 winding; Output 1 winding is AC stacked on top of Output 2 winding
DCR_Ploss_Sec1		0.86	W	Estimated Power loss due to DC resistance (both secondary halves)
ACR_Sec2		3.52	m-ohm	Actual measured AC resistance (at 100 kHz, room temperature), multiply by 1.33 to approximate 100 C winding temperature . Default value of ACR is twice the DCR value at 100 C
ACR_Ploss_Sec2		3.41	W	Estimated AC copper loss (both secondary halves)

Total Copper loss calculation				Does not include fringing flux loss from gap
Primary copper loss (from Primary section)		0.38	W	Total primary winding copper loss at 85 C
Secondary copper Loss		7.80	W	Total copper loss in secondary winding
Transformer copper loss		8.19	W	Total copper loss in transformer (primary + secondary)

URNS CALCULATOR

V1		24.00	V
V1d1		0.70	V
N1	4.00		
V2		11.65	V
V2d2		0.70	V
N2	2.00		

This is to help you choose the secondary turns - not connected to any other part of spreadsheet

- Target Output Voltage Vo1
- Diode drop voltage for Vo1
- Total number of turns for Vo1
- Expected outputV
- Diode drop voltage for Vo2
- Total number of turns for Vo2



Full load Primary and MOSFET RMS currents

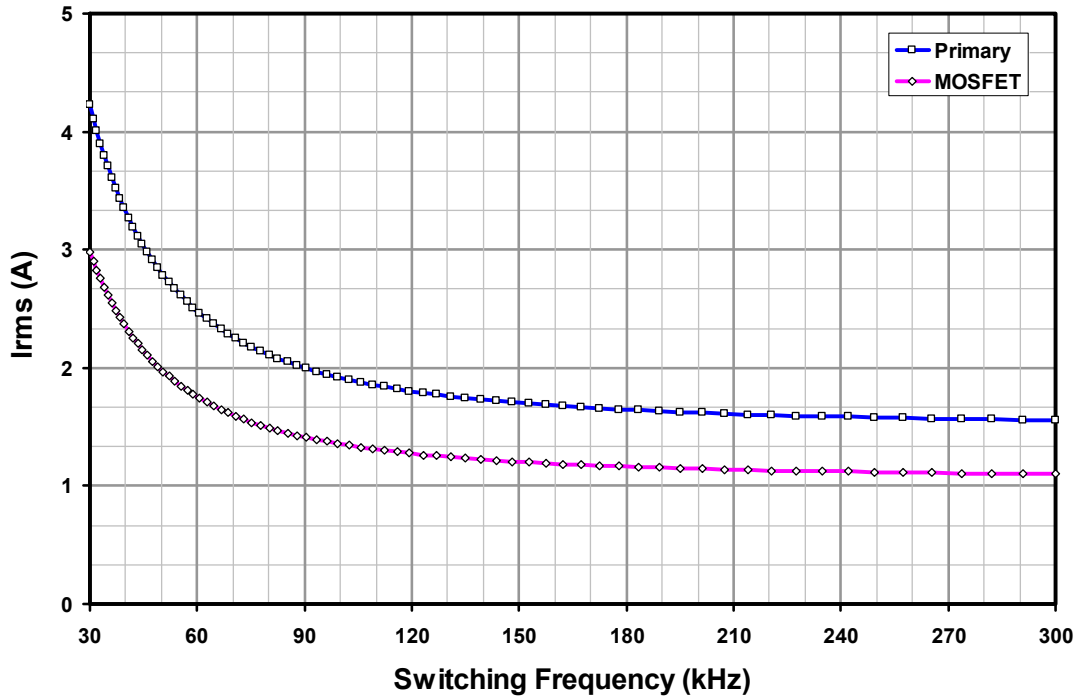

V_{BULK} vs Switching Frequency

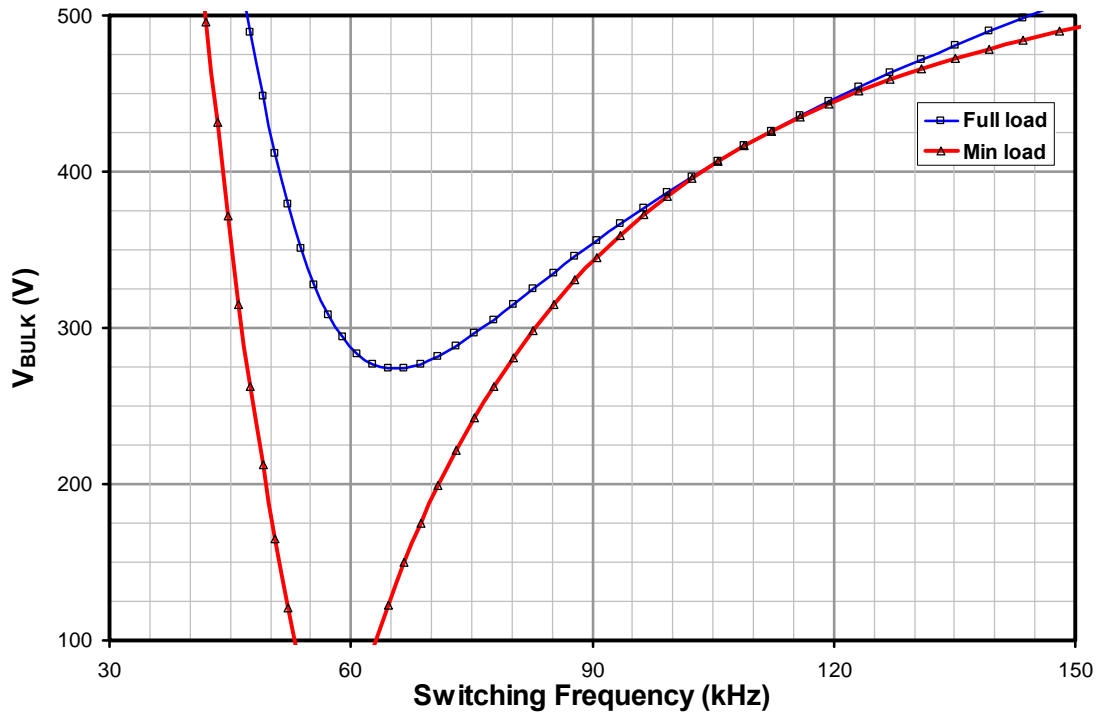

9 RD-189 Performance Data

All measurements were taken at room temperature and 60 Hz input frequency unless otherwise specified, with 60 Hz input frequency. Voltage measurements were taken at the output connectors.

9.1 LLC Stage Efficiency

To make this measurement, capacitor C22 is shorted to allow the supply to operate with no AC input. The LLC stage was supplied by connecting an external HV DC supply across bulk capacitor C9. This supply was set to 385 VDC. The remote on switch was set to the “on” position.

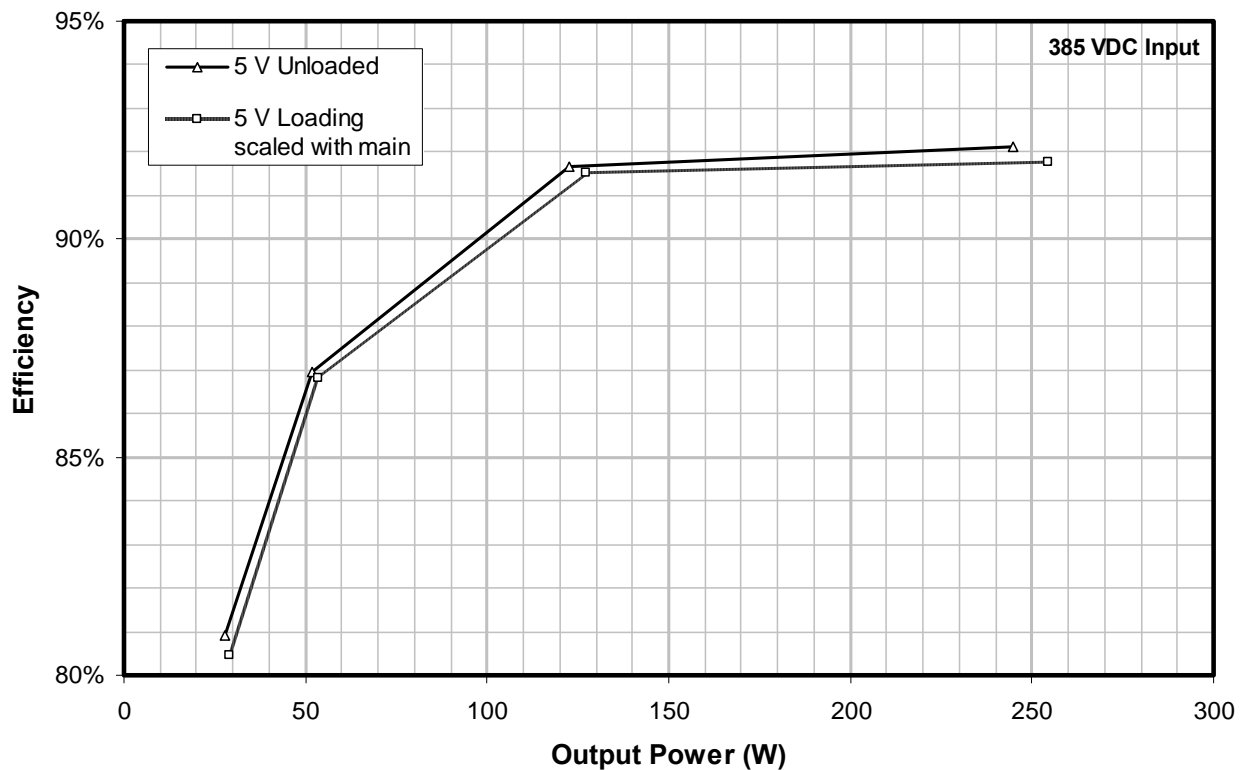

Figure 15 – LLC Stage Efficiency vs. Load, 385 VDC Input.



9.2 Total Efficiency

Figures below show the total supply efficiency (PFC and LLC stages). AC input was supplied using a sine wave source.

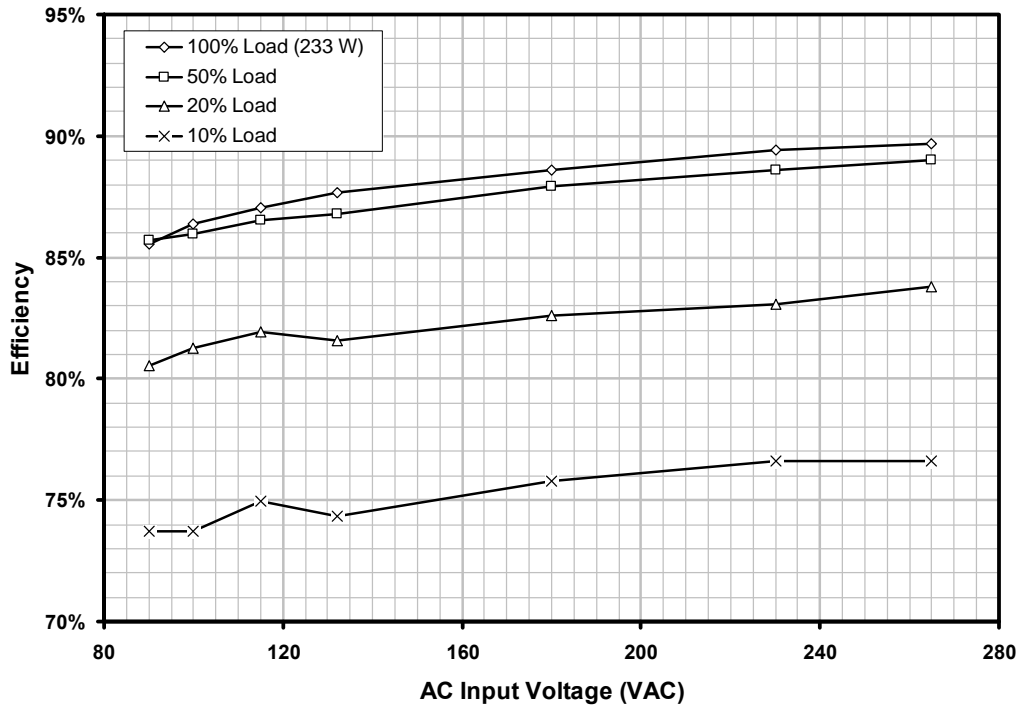

Figure 16 – Total Efficiency vs. Output Power, 5 V Output Loaded.

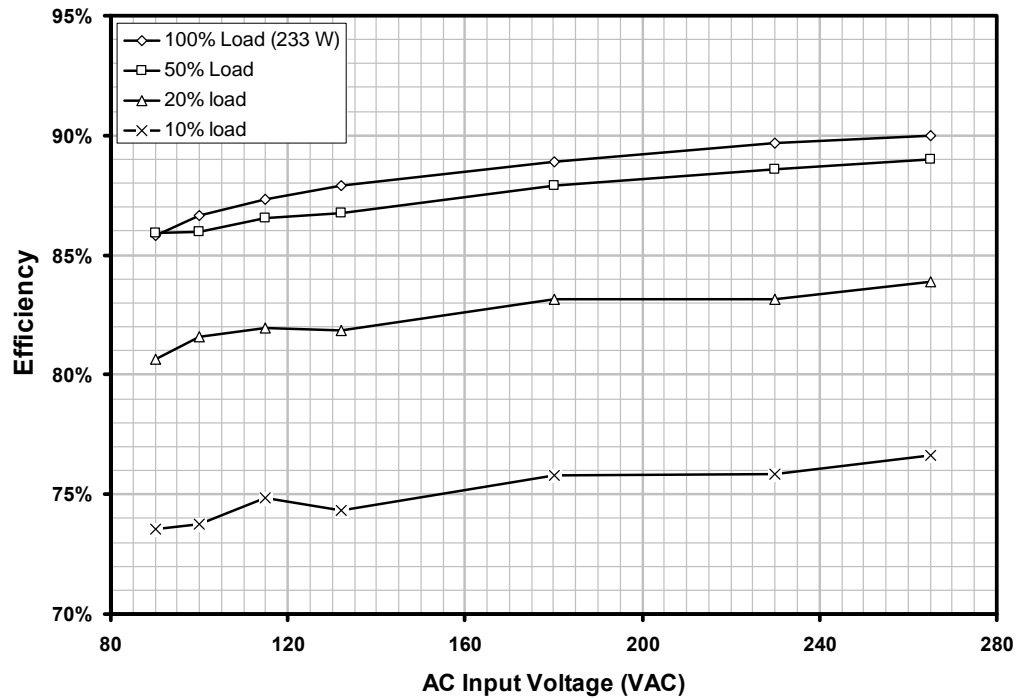

Figure 17 – Total Efficiency vs. Output Power, 5 V Output Unloaded.



9.3 +5 V Standby Output – Input Power vs Output Power

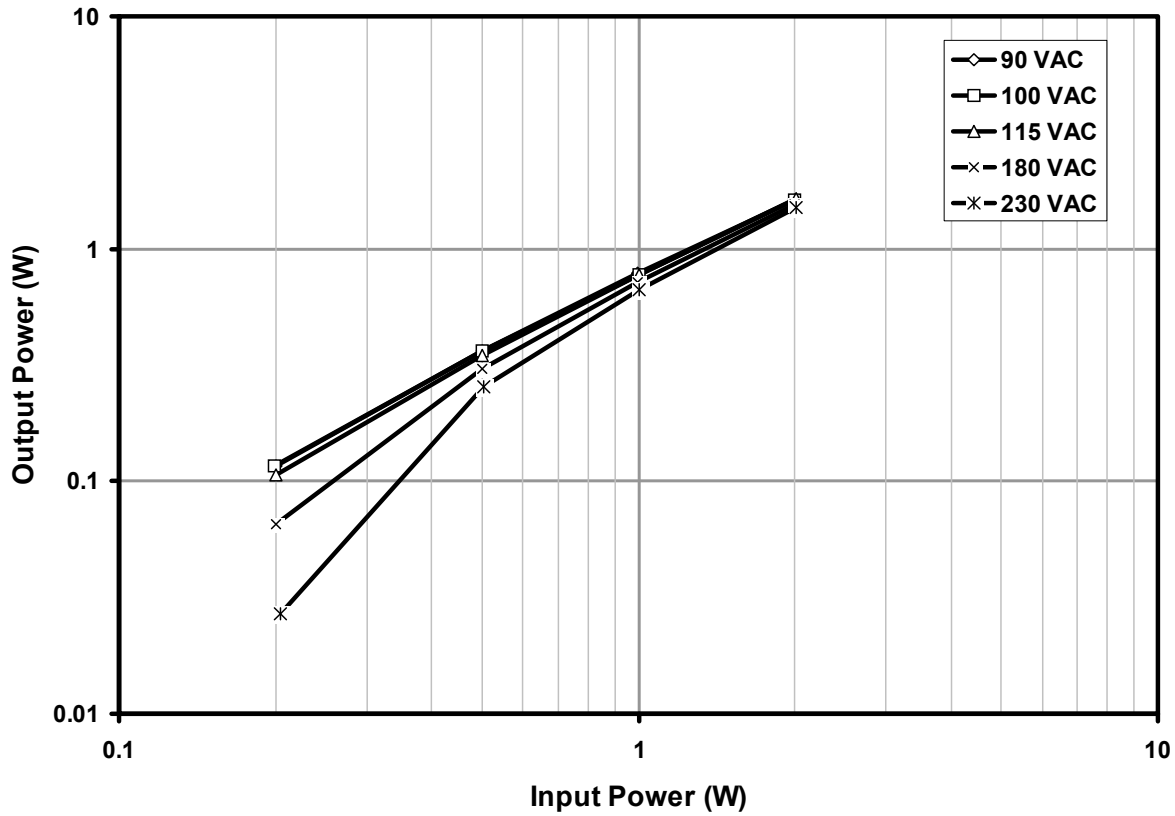

Figure 18 – Standby Input Power vs. Output Power.

The figure above shows standby input power as a function of output power, with the PFC and LLC stages disabled via the remote enable (remote-on switch set to “off” position).



9.4 Standby Load Raw Data

Table 1 shows the raw data taken from standby input power measurements. This is the same data as presented in Figure 18 but allows differentiation between operation at 90 VAC, 100 VAC and 115 VAC.

P_{OUT} vs P_{IN} for Standby Supply				
V_{IN} (VAC)	V_O (V)	I_O (A)	P_{IN} (W)	P_{OUT} (W)
90	5.07	0	0.045	0
90	5.07	0.0229	0.2	0.116
90	5.07	0.0714	0.5	0.362
90	5.07	0.154	0.9999	0.788
90	5.07	0.3208	2.004	1.626
100	5.07	0	0.0507	0
100	5.06	0.0229	0.199	0.116
100	5.07	0.0714	0.499	0.362
100	5.06	0.154	1.002	0.779
100	5.06	0.3208	2	1.623
115	5.07	0	0.0596	0
115	5.07	0.0209	0.2	0.106
115	5.07	0.069	0.5	0.350
115	5.06	0.1529	1.003	0.774
115	5.06	0.323	2.01	1.634
180	5.07	0	0.112	0
180	5.07	0.01299	0.2	0.066
180	5.07	0.0598	0.499	0.303
180	5.07	0.142	0.998	0.720
180	5.06	0.308	2	1.558
230	5.07	0	0.172	0
230	5.07	0.0053	0.205	0.027
230	5.07	0.0505	0.503	0.256
230	5.07	0.1318	1.002	0.668
230	5.07	0.2982	2.009	1.5119

Table 1 – Standby Input Power Raw Data.



9.5 No-Load Input Power

No-load input power was measured using a sine wave source. All supply outputs were unloaded and the remote on switch was in the “off” position.

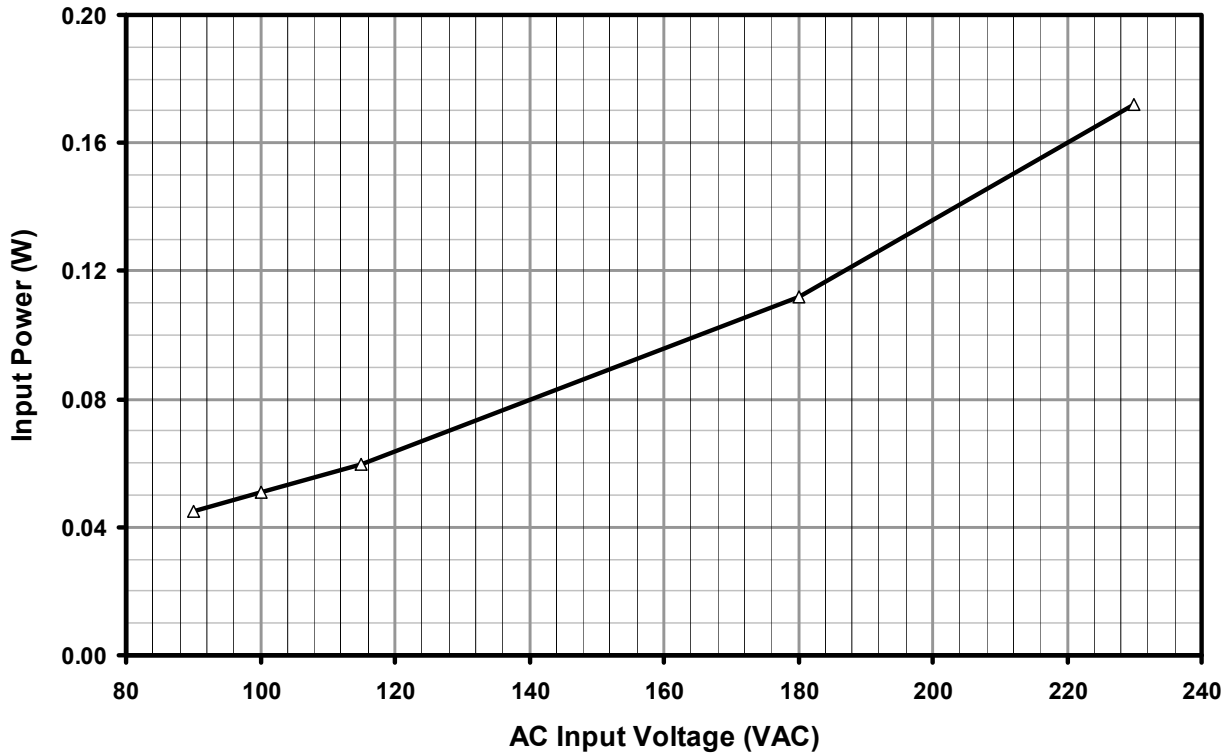

Figure 19 – No-Load Input Power vs. Input Line Voltage, Room Temperature, 60 Hz.



9.6 THD and Power Factor

THD and Power factor measurements were made using a sine wave AC source.

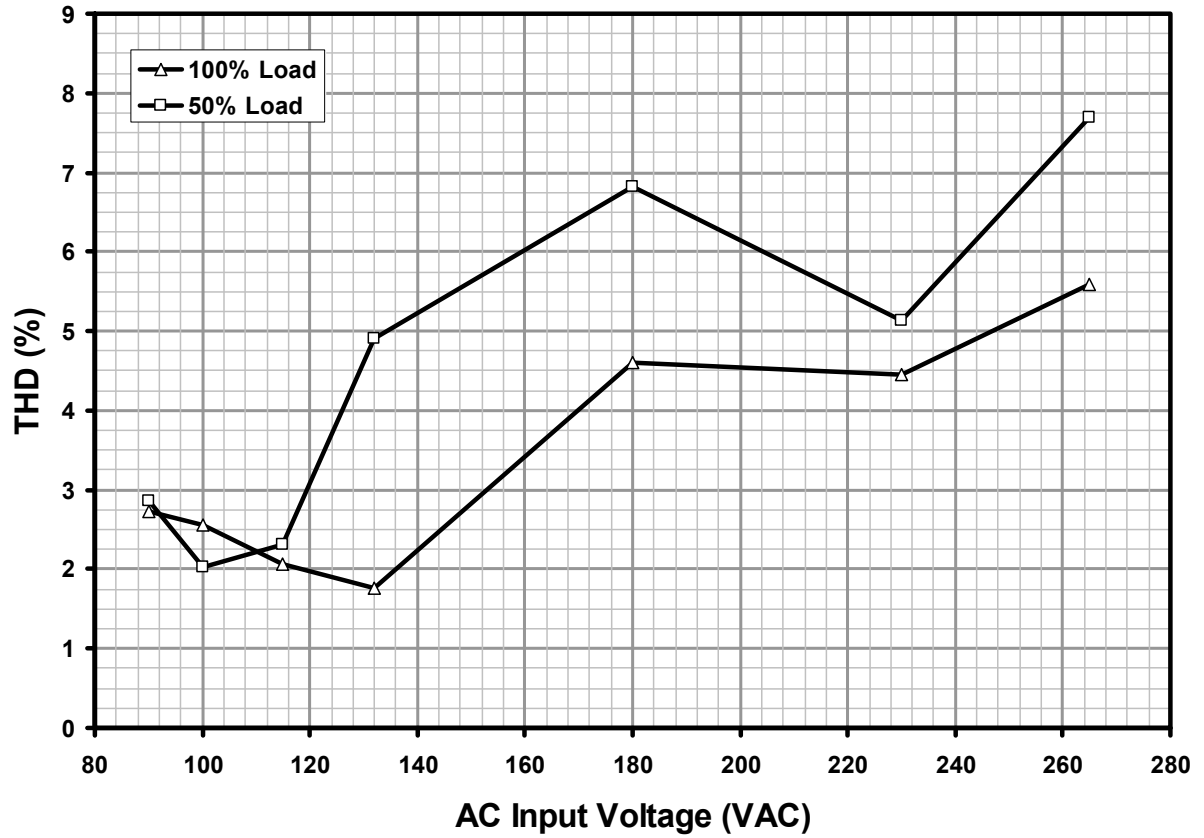

Figure 20 – Input Current THD vs. Input Voltage, 50% and 100% Load.



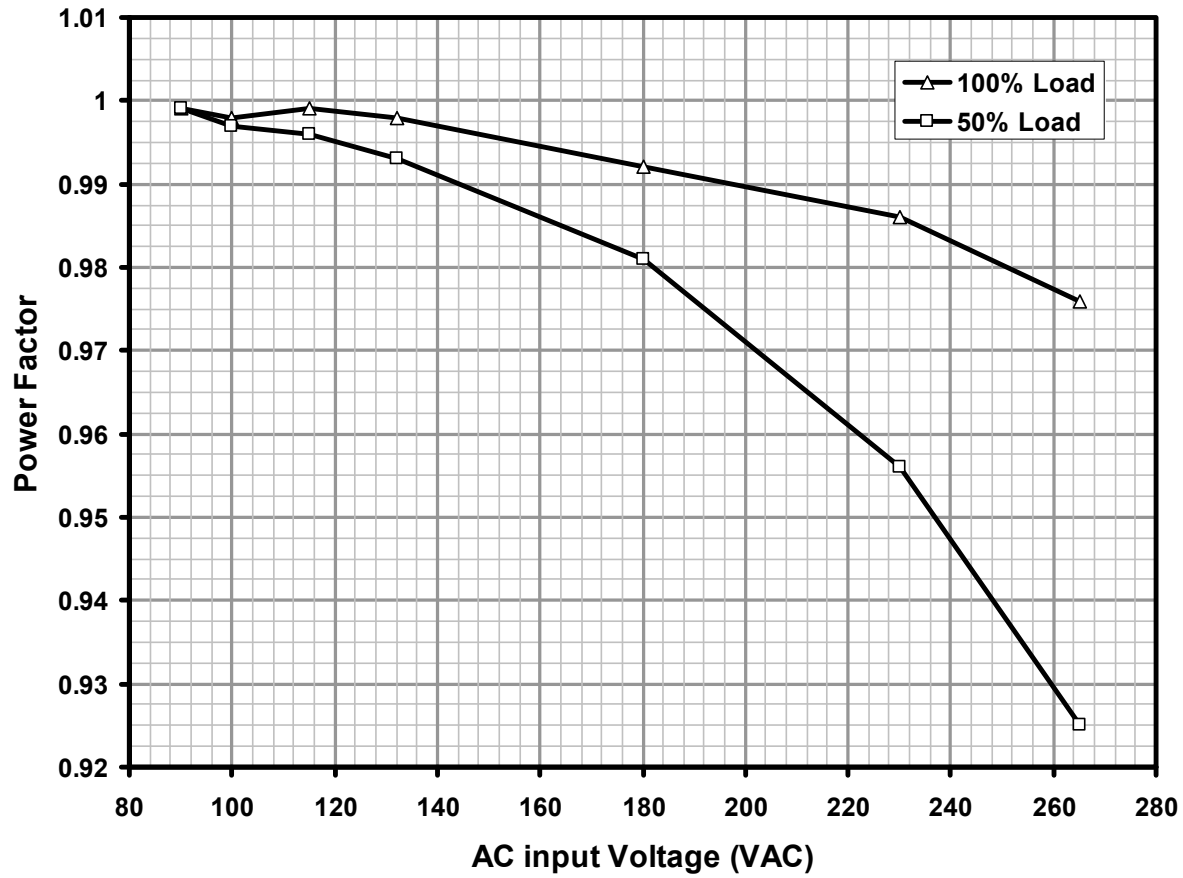

Figure 21 – Power Factor vs. Input Voltage, 50% and 100% Load.



9.7 Output Regulation

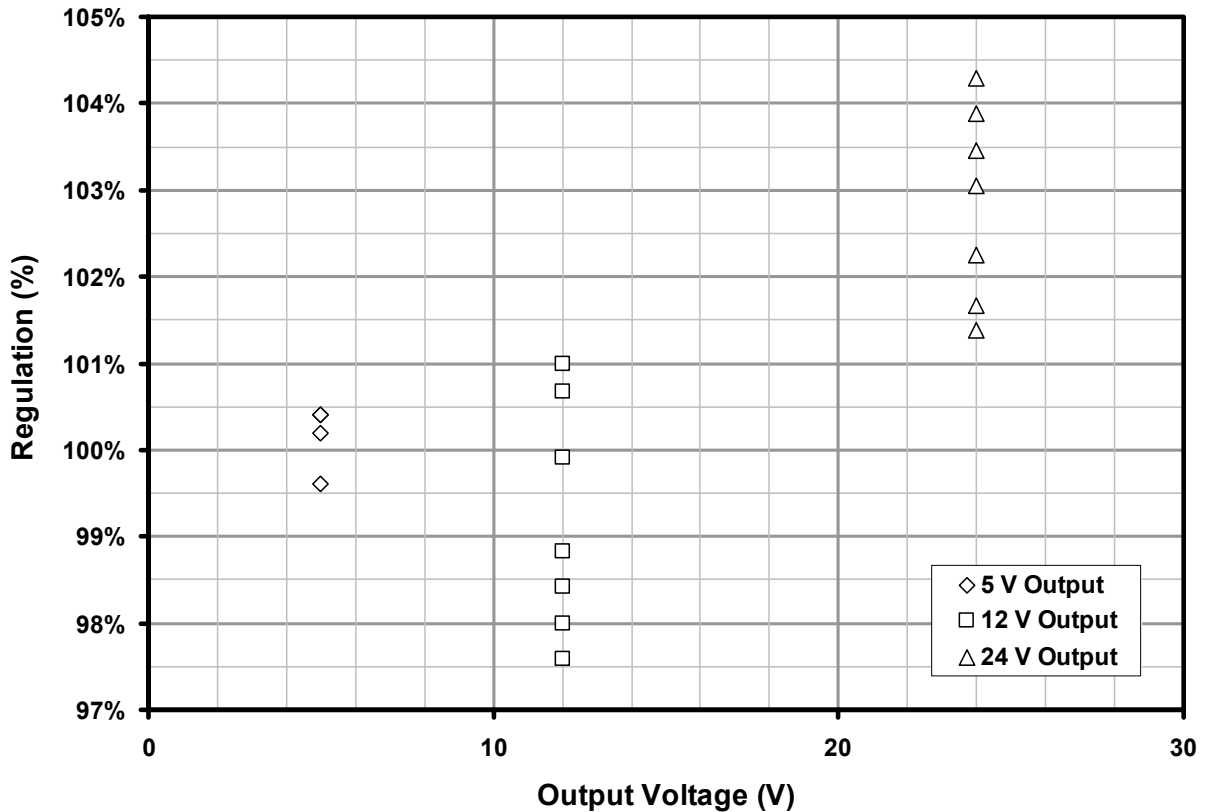

Figure 22 – Output Regulation Across Load (10% to 100% loading).

The graph shows the output voltage variation of the outputs with load. The PFC regulates the LLC and standby supply input voltage under normal conditions so the outputs will not be affected by the AC input voltage. Variations due to temperature and component tolerances are not represented.

The 12 V and 24 V outputs vary by less than 5%. The feedback circuit has equal weighting between the two outputs. If one output needs to be more tightly regulated then the other will suffer poorer regulation.



10 Waveforms

10.1 Input Voltage and Current

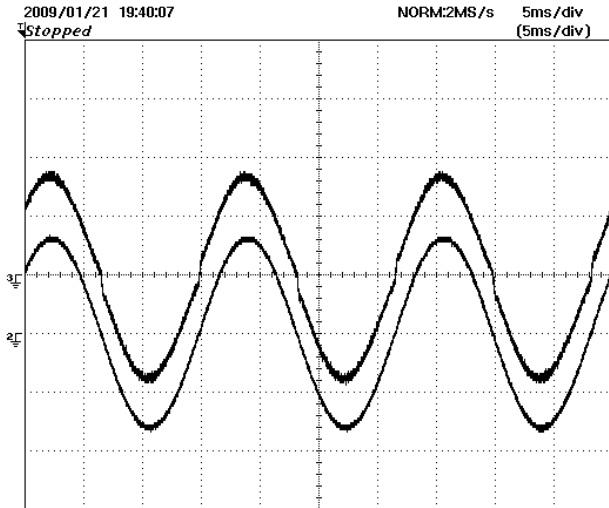

Figure 23 – 115 VAC, 225 W Load.
Top Trace: Input Current, 2 A / div.
Bottom Trace: Input Voltage, 100 V, 5 ms/div.

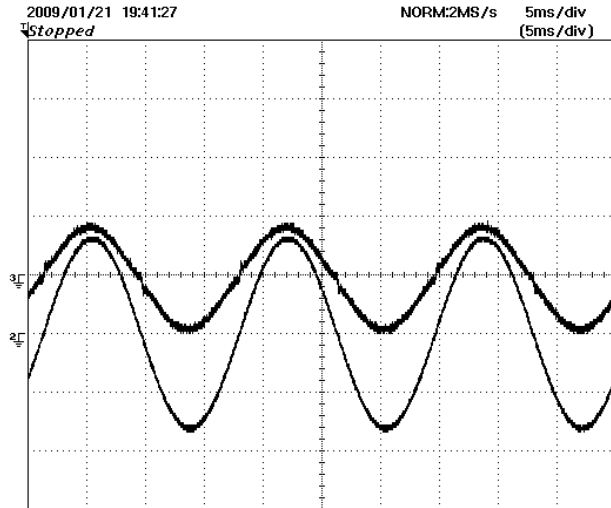

Figure 24 – 115 VAC, 118 W Load.
Top Trace: Input Current, 1 A / div.
Bottom Trace: Input Voltage, 100 V, 5 ms / div.

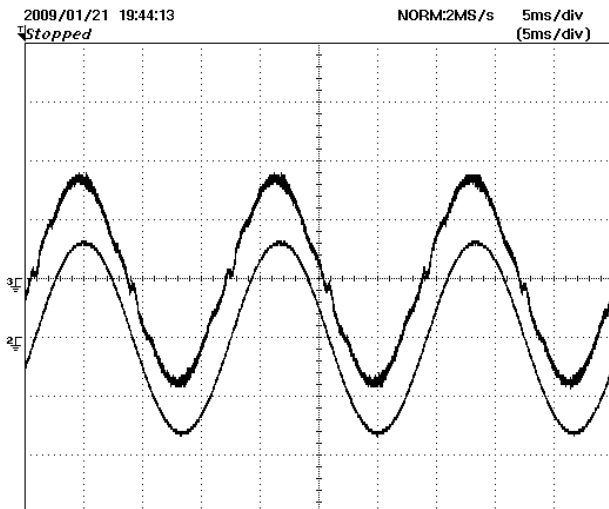

Figure 25 – 230 VAC, 225 W Load.
Top Trace: Input Current, 1 A, 5 ms / div.
Bottom Trace: Input Voltage, 200 V / div.

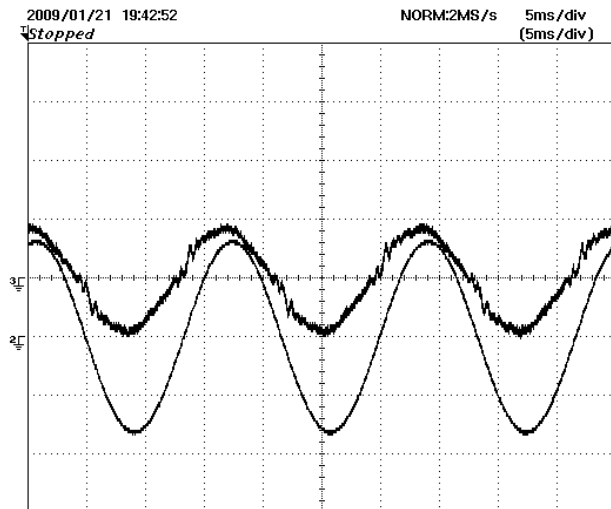

Figure 26 – 230 VAC, 118 W Load.
Top Trace: Input Current, 1 A, 5 ms / div.
Bottom Trace: Input Voltage, 200 V / div.



10.2 LLC Primary Voltage and Current

The LLC stage current was measured by replacing jumper JP26 with a current sensing loop that measures the LLC transformer (T3) primary current. The primary voltage waveform was measured at the hot side of ferrite bead inductor L6.

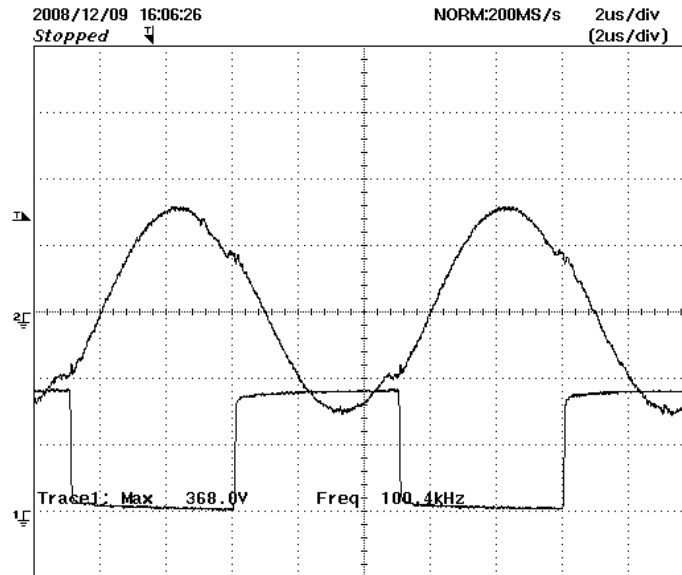

Figure 27 – LLC Stage Primary Voltage and Current.
Top Trace: Current, 2 A / div.
Bottom Trace: Voltage, 200 V, 2 μ s / div.



10.3 PFC Switch Voltage and Current - Normal Operation

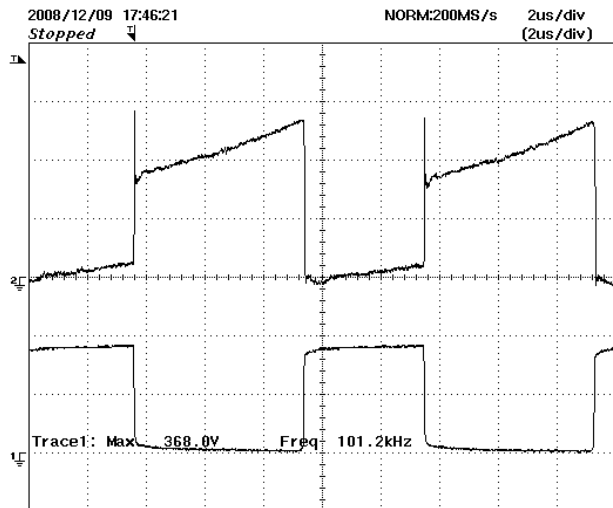

Figure 28 – 115 VAC Input, 100% Load.
 Top Trace: Q2 Drain Current, 2 A/div, 2 μ s / div.
 Bottom Trace: Drain Voltage, 200 V, 2 μ s / div.

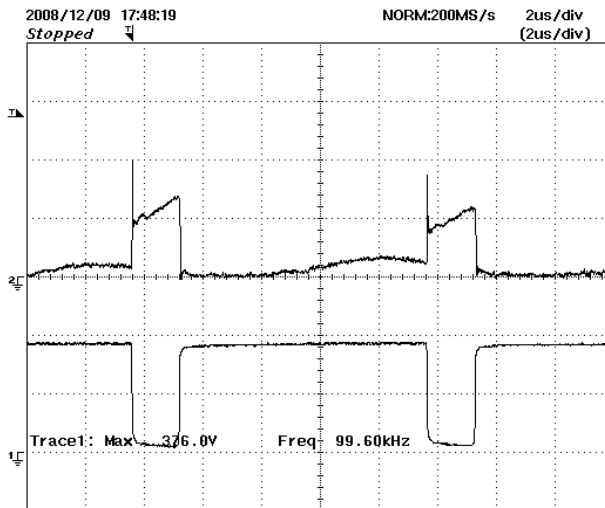

Figure 29 – 230 VAC Input, 100% Load.
 Top Trace: Q2 Drain Current, 2 A / div, 2 μ s / div.
 Bottom Trace: Drain Voltage, 200 V, 2 μ s / div.

10.4 AC Input Current and PFC Output Voltage during Startup

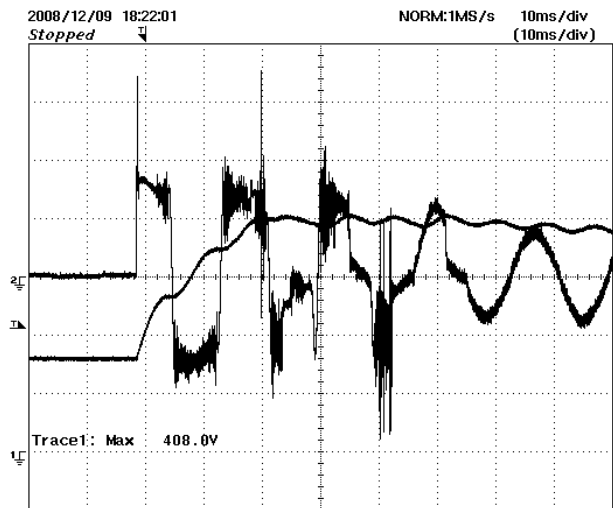

Figure 30 – Full Load, 115 VAC.
 Top Trace: AC Input Current, 5 A / div.
 Bottom Trace: PFC Voltage, 100 V, 10 ms / div.

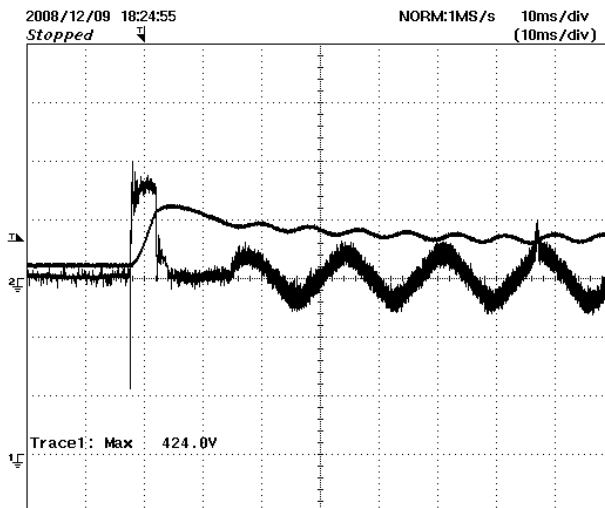

Figure 31 – Full Load, 230 VAC.
 Top Trace: AC Input Current, 5A / div.
 Bottom Trace: PFC Voltage, 100 V, 10 ms / div.



10.5 LLC Startup

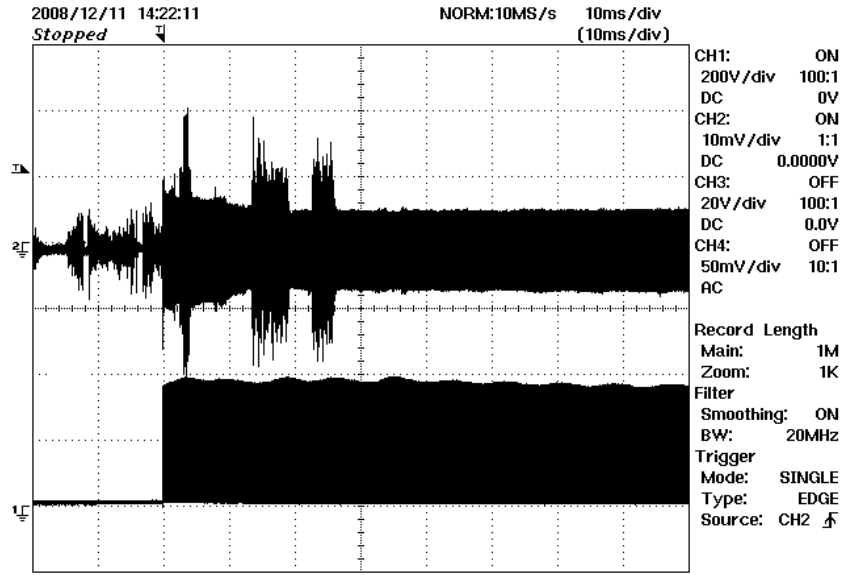

Figure 32 – LLC Startup. 115 VAC, 100% Load, Using Remote Start.
Top Trace: LLC Primary Current, 5 A / div.
Bottom Trace: Q11 Drain Voltage, 200 V, 10 ms / div.



10.6 LLC Output Short Circuit

The figure below shows the effect of a 24 V output short circuit on the LLC primary current. A mercury displacement relay was used to short the 24 V output to get a fast, bounce-free connection.

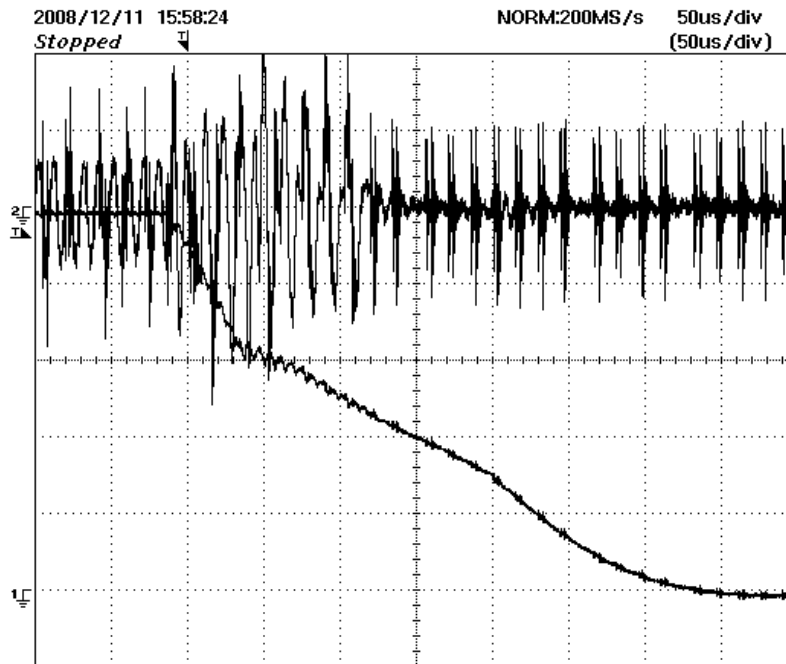

Figure 33 – Output Short Circuit Test (24 V).
Top Trace: LLC Primary Current, 5 A / div.
Bottom Trace: 24 V Output, 5 V, 50 μs / div.



10.7 Output Voltage during Startup and Shutdown

10.7.1 Standby Supply

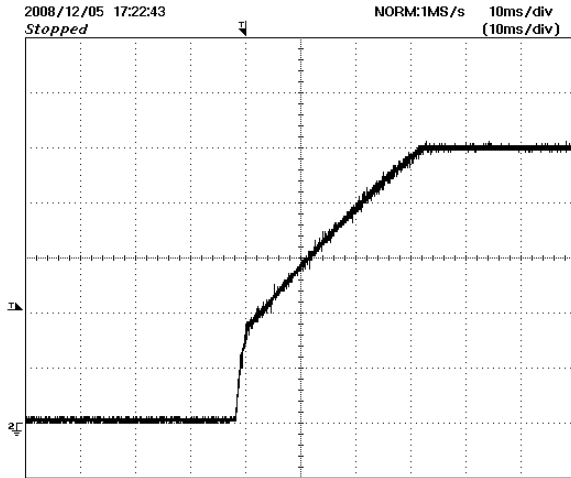

Figure 34 – 5 V Standby Output at Start-up. 115 VAC Input. No Load. 1 V, 10 ms / div.

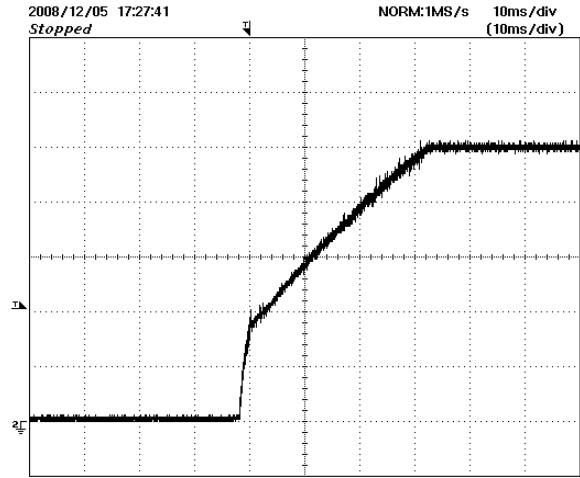

Figure 35 – 5 V Standby Output at Start-up. 115 VAC Input. 100 mA Load. 1 V, 10 ms / div.

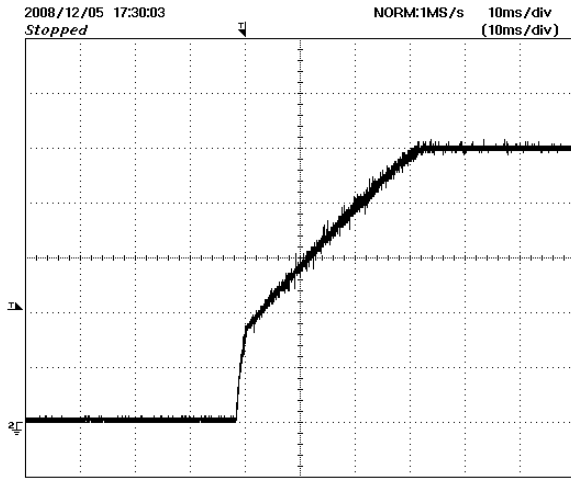

Figure 36 – 5 V Standby Output at Start-up. 230 VAC Input. No Load. 1 V, 10 ms / div .

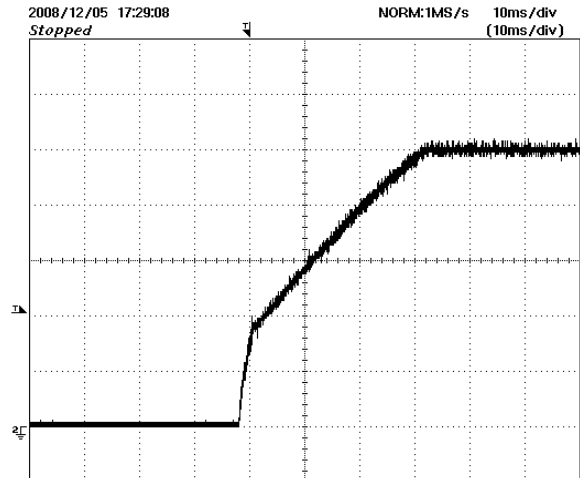

Figure 37 – 5 V Standby Output at Start-up. 230 VAC Input. 100 mA Load. 1 V, 10 ms / div.

10.7.2 LLC (Main) Supply

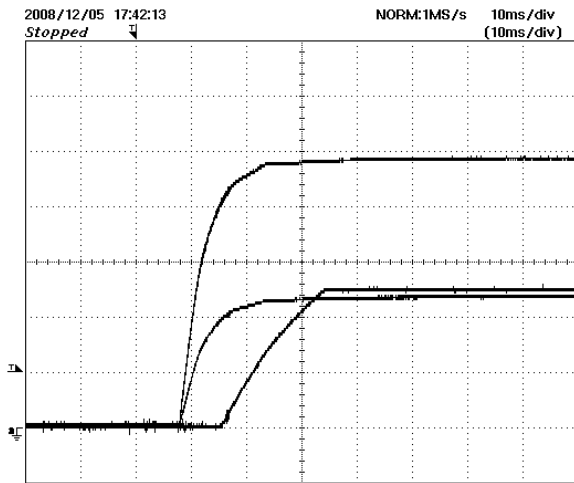

Figure 38 – Output Startup, 115 VAC, No Load.
 Top Trace: 24 V Output, 5 V / div.
 Middle Trace: 12 V Output, 5 V / div.
 Bottom Trace: 5 V Output, 2 V, 10 ms / div.

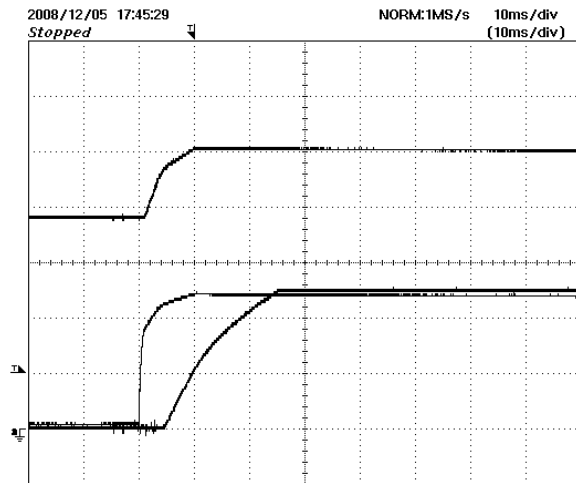

Figure 39 – Output Startup, 230 VAC, No Load.
 Top Trace: 24 V Output, 5 V / div.
 Middle Trace: 12 V Output, 5 V / div.
 Bottom Trace: 5 V Output, 2 V, 10 ms / div.

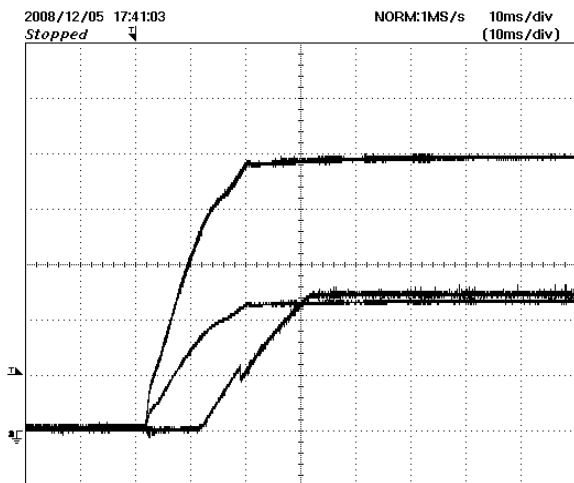

Figure 40 – Output Startup, 115 VAC, Full Load.
 Top Trace: 24 V Output, 5 V / div.
 Middle Trace: 12 V Output, 5 V / div.
 Bottom Trace: 5 V Output, 2 V, 10 ms / div.

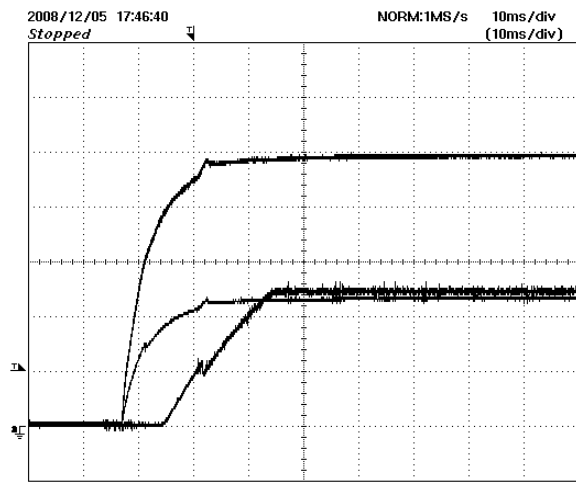

Figure 41 – Output Startup, 230 VAC, Full Load.
 Top Trace: 24 V Output, 5 V / div.
 Middle Trace: 12 V Output, 5 V / div.
 Bottom Trace: 5 V Output, 2 V, 10 ms / div.



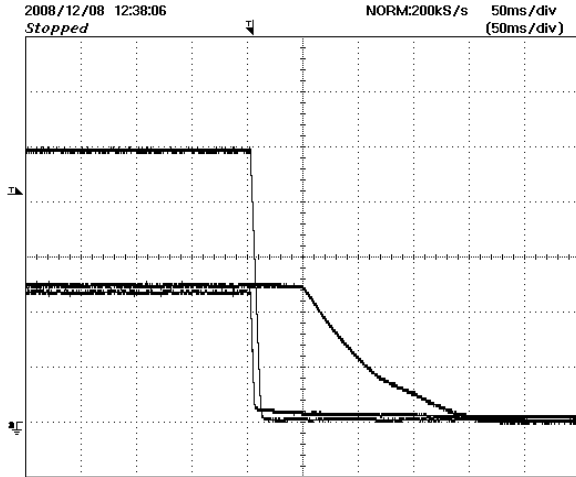

Figure 42 – Shutdown, 115 VAC, Full Load.
 Top Trace: 24 V Output, 5 V / div.
 Middle Trace: 5 V Output, 2 V / div.
 Bottom Trace: 12 V Output, 5 V, 10 ms / div.

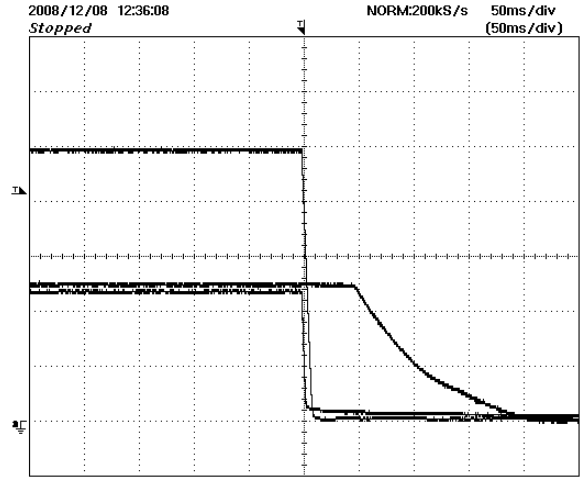

Figure 43 – Shutdown, 230 VAC, Full Load.
 Top Trace: 24 V Output, 5 V / div.
 Middle Trace: 5 V Output, 2 V / div.
 Bottom Trace: 12 V Output, 5 V, 10 ms / div.



10.8 Output Holdup Time

Full load output holdup time was measured with the AC supply removed at zero crossing. Measurements were taken at 115 VAC input, 60 Hz. A holdup time of 28 ms was measured.

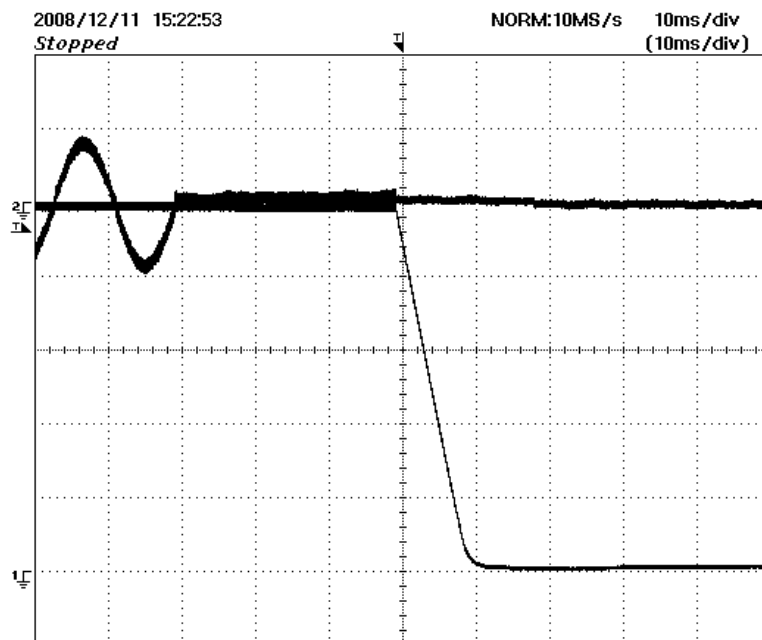

Figure 44 –24 V Output Holdup, 115 VAC, Full Load on all Outputs.
Top Trace: AC Input Current, 5 A / div.
Bottom Trace: 24 V Output, 5 V, 10 ms / div.



10.9 Output Ripple Measurements

10.9.1 Ripple Measurement Technique

For DC output ripple measurements, use a modified oscilloscope test probe to reduce spurious signals. Details of the probe modification are provided in figures below.

Tie two capacitors in parallel across the probe tip of the 4987BA probe adapter. Use a 0.1 μF / 50 V ceramic capacitor and 1.0 μF / 50 V aluminum electrolytic capacitor. The aluminum-electrolytic capacitor is polarized, so always maintain proper polarity across DC outputs.

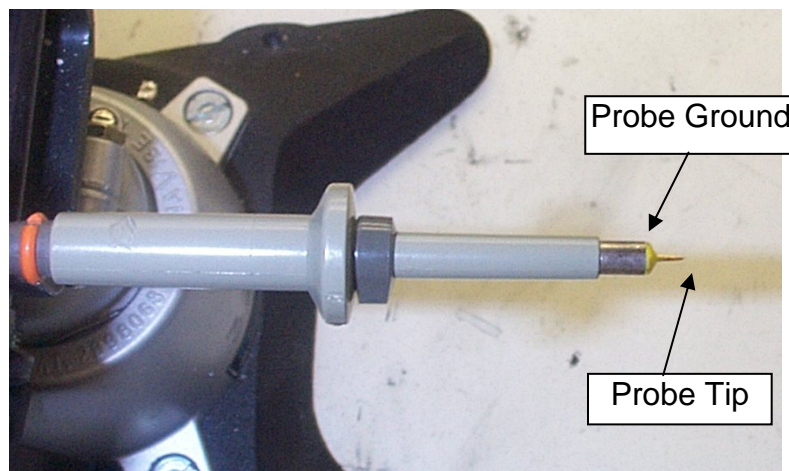

Figure 45 – Oscilloscope Probe Prepared for Ripple Measurement (End Cap and Ground Lead Removed).



Figure 46 – Oscilloscope Probe with Probe Master 4987BA BNC Adapter (Modified with Wires for Probe Ground for Ripple measurement and Two Parallel Decoupling Capacitors Added).

10.9.2 Full Load Output Ripple Results

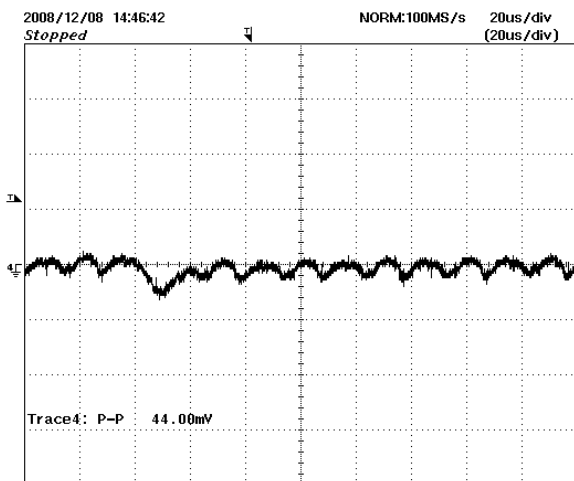

Figure 47 – 5 V Output Ripple, 50 mV, 50 μ s / div.

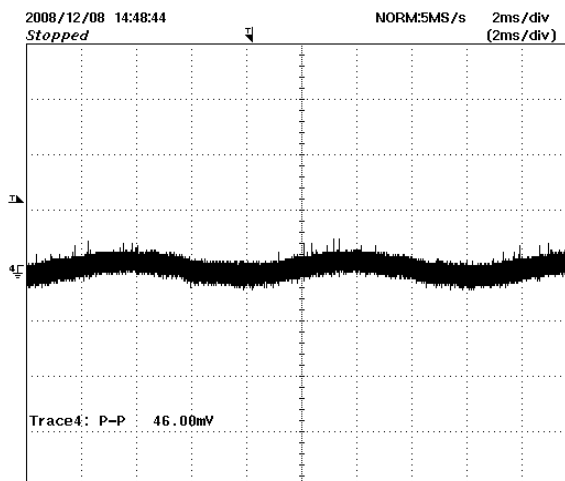

Figure 48 – 12 V Output Ripple, 50 mV, 5 ms / div.

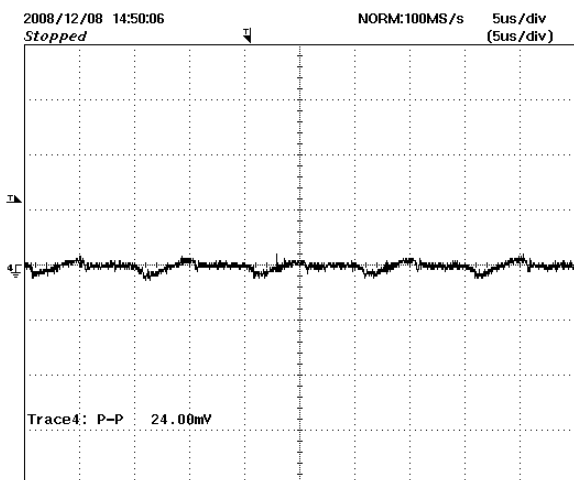

Figure 49 – 12 V Output Ripple, 50 mV, 2 μ s / div.

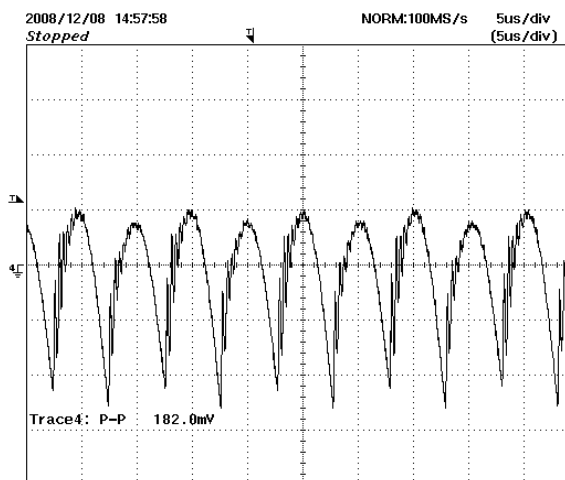

Figure 50 – 24 V Output Ripple, 50 mV, 2 μ s / div.



10.9.3 Output Load Step Response

The figures below show transient response with a 75%-100%-75% load step for both the 5 V and the 24 V output.

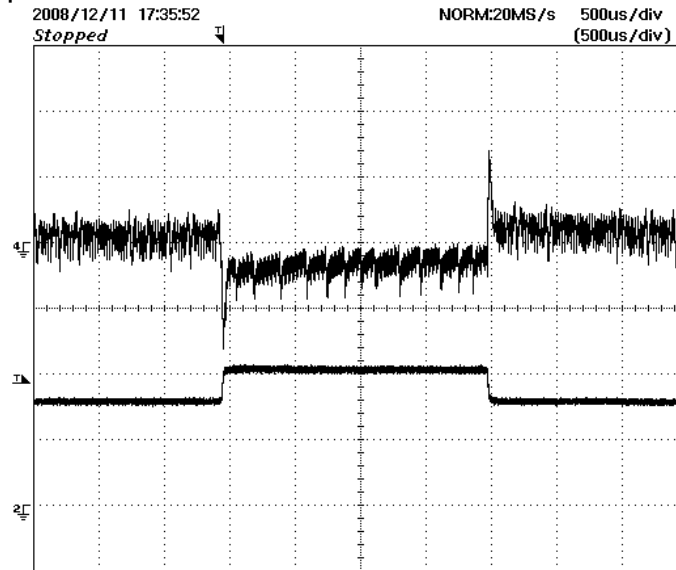

Figure 51 – 5 V Output Transient Response 1.5 A – 2 A – 1.5 A Load Step.
5 V Standby Output Unloaded, +12 V, +24 V Outputs Full Load.
Top Trace: 5 V Transient Response, 50 mV / div.
Bottom Trace: 5 V Load Step, 1 A, 500 μ s / div.

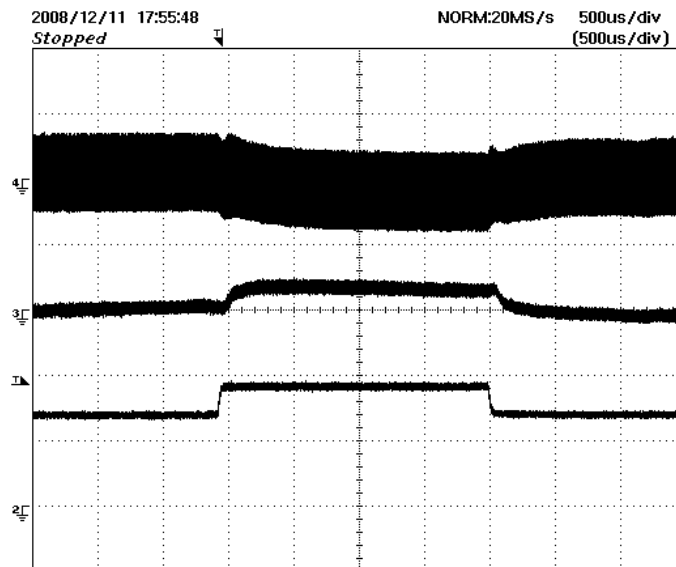

Figure 52 – 12 V / 24 V Output Transient Response
6.75 A – 9 A – 6.75 A Load Step on 24 V. 5 V, 12 V, Outputs Full Load.
Top Trace: 24 V Transient Response, 200 mV / div.
Middle Trace: +12 V Transient Response, 100 mV / div.
Bottom Trace: 24 V Load Step, 5 A, 500 μ s / div.



11 Temperature Profiles

The board was operated at room temperature in a vertical orientation as show below. Tape was placed on top of the two main heatsinks to correct emissivity and allow accurate temperature measurements when using an infra red (IR) camera. For each test condition the unit was allowed to thermally stabilize (>1 hr) before measurement were made. Infra red measurements were correlated to thermocouples attached using thermally conductive adhesive (Artic Silver).

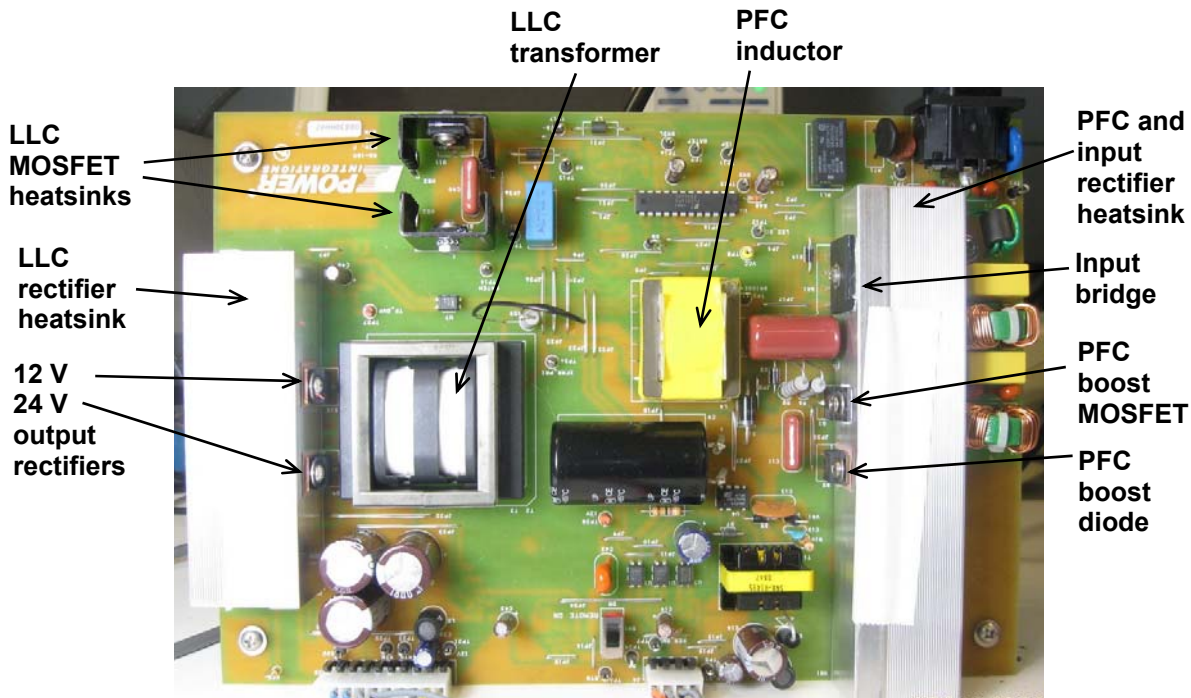

Figure 53 – Photograph of Board Orientation used for Thermal Testing.



11.1 Thermal Results Summary

11.1.1 Testing Conditions

Testing was performed under conditions commonly specified by LCD TV manufacturers. The goal of the design is to maintain the temperature of components below 100 C at rated ambient and 80% load (184 W), low line (108 VAC, 57 Hz). In addition no component shall exceed the manufacturers limit under conditions of full load (225 W) and abnormal low line condition (90 VAC, 47 Hz).

In both cases this design meets these requirements with extrapolated maximum temperatures of 99 °C for the PFC choke and 94°C for the LLC transformer secondary winding. Should a lower PFC choke temperature be desired then an alternate design is presented below.

Measurement data is presented below. The unit was allowed to thermally stabilize (> 1 hours in all cases) before gathering data. Semiconductor plastic and heatsink temperatures were correlated via thermocouples attached with adhesive.

For the LLC transformer the secondary winding was 10-15 °C hotter than the primary. For the LLC rectifiers D9 (24 V output) was 10°C hotter than D10 (12 V output). Therefore only D9 and the secondary winding temperatures are shown below.

	108 VAC, 57 Hz	108 VAC, 57 Hz	90 VAC, 47 Hz
Output Power (W)	230.1	184.1	230.1
Input Power (W)	264.7	211.1	268.3
Efficiency (%)	86.9%	87.2%	85.8%
Output Loading 12 V	4 A (11.83 V)	3.2 A (11.86 V)	4 A (11.83 V)
Output Loading 24 V	7 A (24.68V)	5.6 A (24.66 V)	7 A (24.69 V)
Output Loading 5 V	2 A (5.02 V)	1.6 A (5.03V)	2 A (5.02 V)
Temperatures (°C)			
Ambient	25	25	25
LLC rectifier heatsink	67	60	67
LLC rectifier plastic package (D9)	82	69	80
LLC MOSFET heatsink (Q10/Q11)	64	55	64
LLC MOSFET plastic package	67	57	66
PFC and rectifier Heatsink	71	63	76
PFC diode plastic package (D2)	76	68	84
PFC MOSFET plastic package (Q2)	82	72	91
Bridge rectifier plastic package (BR1)	80	70	87
LLC transformer (T2) surface (secondary)	91	79	90
PFC inductor (L4) winding surface	94	84	97



11.2 90 VAC, 47 Hz, 225 W_{OUT}

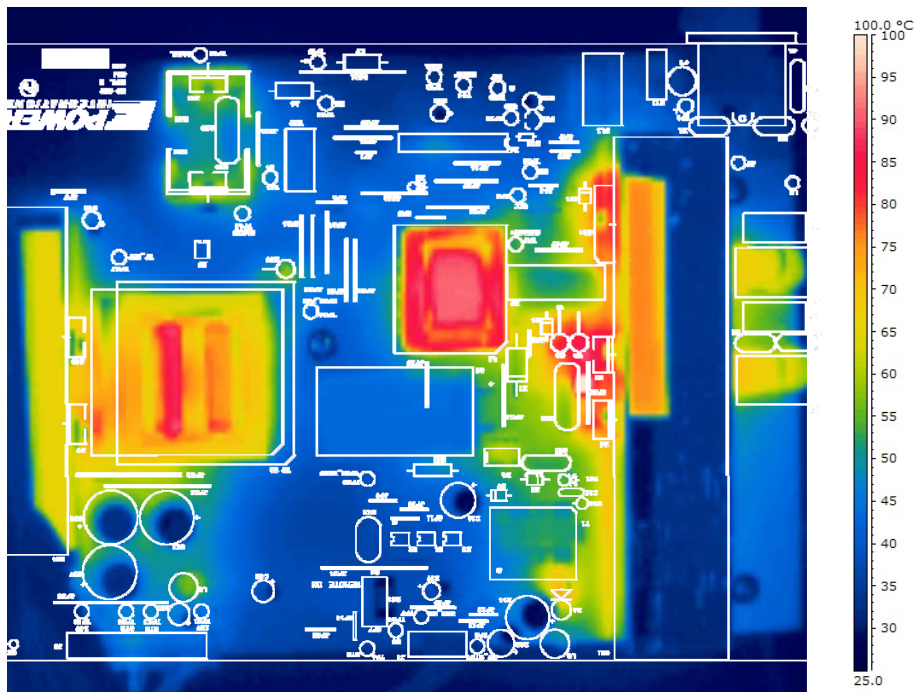

Figure 54 – Thermal Profile. Room Temperature, 90 VAC, 47 Hz, 225 W Load (1 hr).

11.3 108 VAC, 57 Hz, 225 W_{OUT}

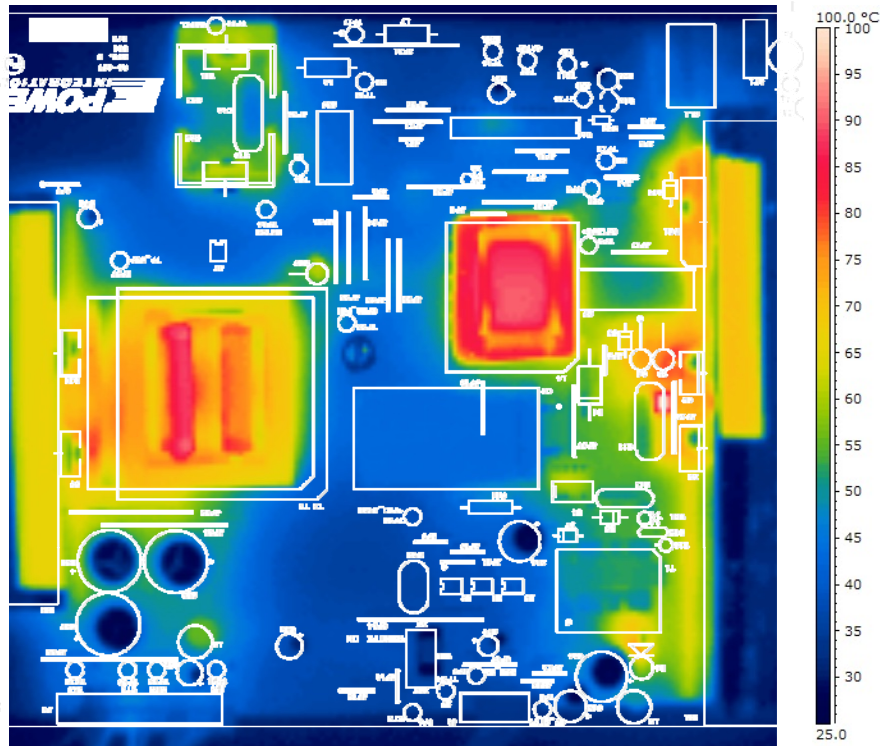

Figure 55 – Thermal Profile. Room Temperature, 108 VAC, 57 Hz, 225 W Load (1 hr).



11.4 108 VAC, 57 Hz, 185 W_{OUT}

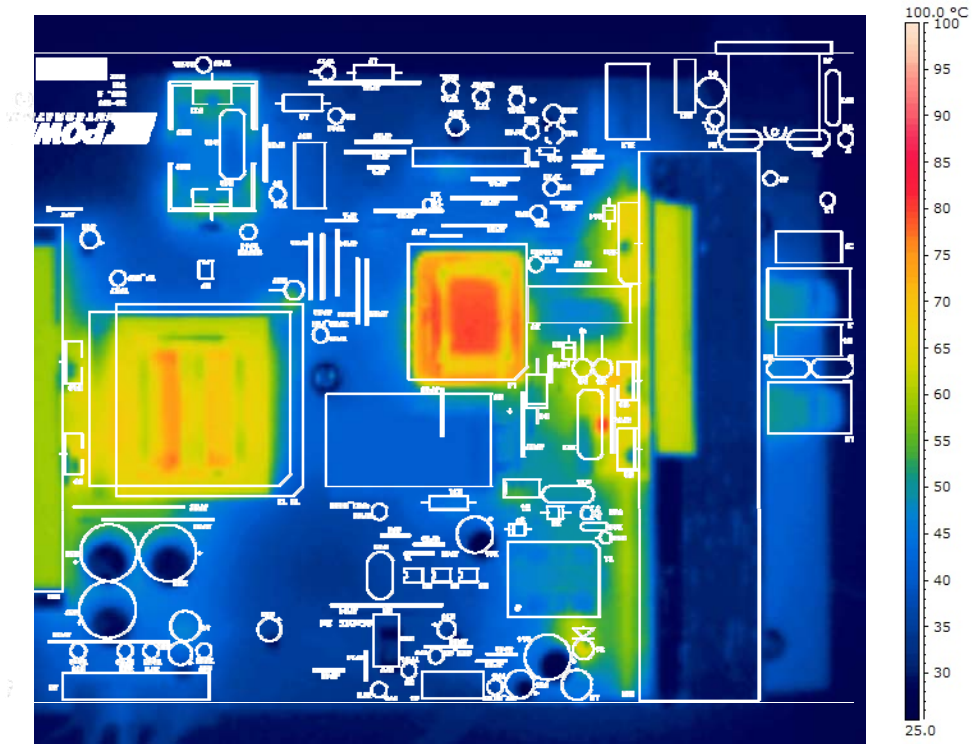

Figure 56 – Thermal Profile. Room Temperature, 108 VAC, 57 Hz, 185 W Load (1 hr).



11.5 Alternate PFC Choke Designs for Lower Operating Temperature

The two PFC choke designs provide a lower choke operating temperature.

Choke Type	Choke Temperature
	90 VAC, 286 W Output, 25°C
Original EE35	115 °C
EE41	72 °C
34 mm Toroid	81 °C

11.5.1 34 mm Toroidal Choke

11.5.1.1 Electrical Diagram

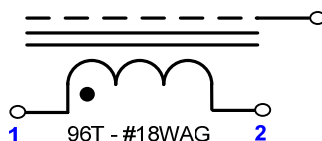

Figure 57 – Electrical Diagram, Toroidal PFC Inductor

11.5.1.2 Electrical Specification

Inductance: 576 $\mu\text{H} \pm 15\%$

11.5.1.3 Materials

Item	Description
[1]	Toroid: Sendust, 60 μ 34 mm OD x 19 mm. ID x 12 mm HT, Chang Sung CS330060 or equivalent.
[2]	Magnet Wire: #18 AWG, solderable double coated.
[3]	Tape Polyester Film, 3M 1350F-1, or equivalent, 19.5 mm wide.
[4]	Tape, Copper Foil, 3M 1125, or equivalent, 14 mm wide.
[5]	Wire, hook-up, #22 AWG UL1015, black.
[6]	Tie wrap Nylon 99 mm Panduit PLT-IM or equivalent



11.5.1.4 Build Diagram

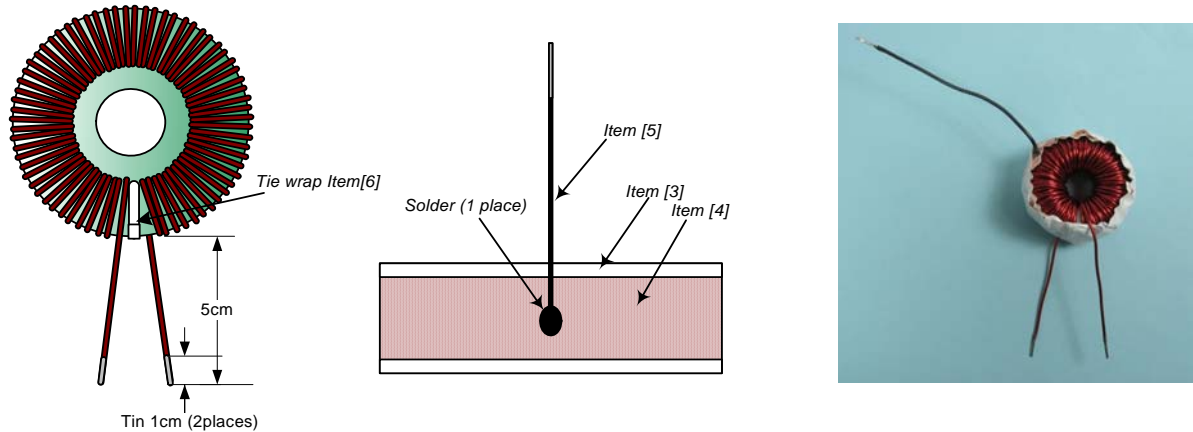

Figure 58 – Build Diagram, Toroidal PFC Inductor.

11.5.1.5 Winding Instructions

1	Apply tie wrap (item [6]) to core as shown in build diagram
2	Wind 47 turns of wire (item [2]) to form one complete layer.
3	Reverse the winding direction and apply 36 turns on top of previous layer to form complete second layer.
4	Reverse winding direction, apply 13 turns on top of second layer to form ~1/4 third layer.
5	Apply 3 turns of tape (item [3]) around core circumference.
6	Apply 1 turn of copper tape (item [4]) around circumference of core with ends overlapping 2-3 mm. Solder end of tape to form shorted turn.
7	Take 7cm of hook-up wire (item[5]) , strip ends 1 cm, solder 1 end of wire to copper foil as shown in build diagram, approximately 90 degrees clockwise around core circumference from start and finish leads.
8	Apply 2 turns of tape (item [3]) around the core circumference.
9	Trim start and finish leads to 5 cm, solder tin ends 1 cm. (Figure1). Finished inductor should appear as shown in build diagram



11.5.1.6 Temperature Measurement for Toroidal Inductor

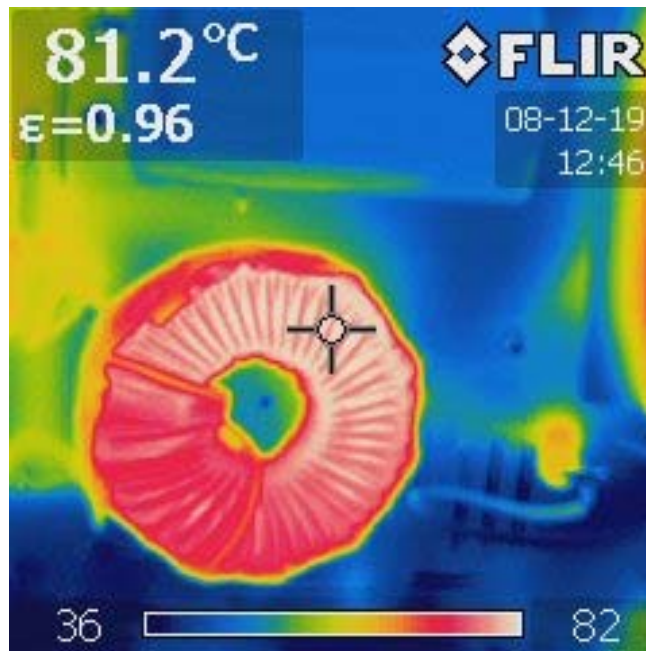

Figure 59 – Temperature Measurement for Toroidal PFC Inductor
90 VAC input, Room Temperature, 286 W Output Power.

11.5.2 PFC Choke Using EE41/33 Core

11.5.2.1 Electrical Diagram, EE 41/33 PFC Choke

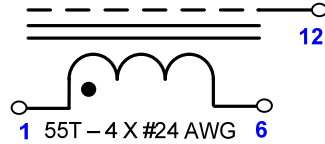

Figure 60 – Electrical Diagram, EE 41/33 PFC Choke.

11.5.2.2 Electrical Specification

Inductance: 576 $\mu\text{H} \pm 15\%$

Note – Do not measure inductance without copper strap in place

11.5.2.3 Materials

Item	Description
[1]	E Core Pair: Sendust, 60 μ , EE41/33 Chang Sung S060 EE41/33 or equivalent.
[2]	Bobbin, E21, Horizontal, 12 pin, Ferroxcube CPH-E41/12-1S-12PD-Z or equivalent
[3]	Magnet Wire: #24 AWG, solderable double coated.
[4]	Tape Polyester Film, 3M 1350F-1 or equivalent, 19 mm wide.
[5]	Tape Polyester Film, 3M 1350F-1 or equivalent, 10 mm wide.
[6]	Tape, Copper Foil, 3M 1125 or equivalent, 17 mm wide.
[7]	Wire, tinned bus, #24 AWG.
[8]	Transformer Varnish, Dolph BC-359 or equivalent (must be baking vs. air-dry varnish)

11.5.2.4 Build Diagram

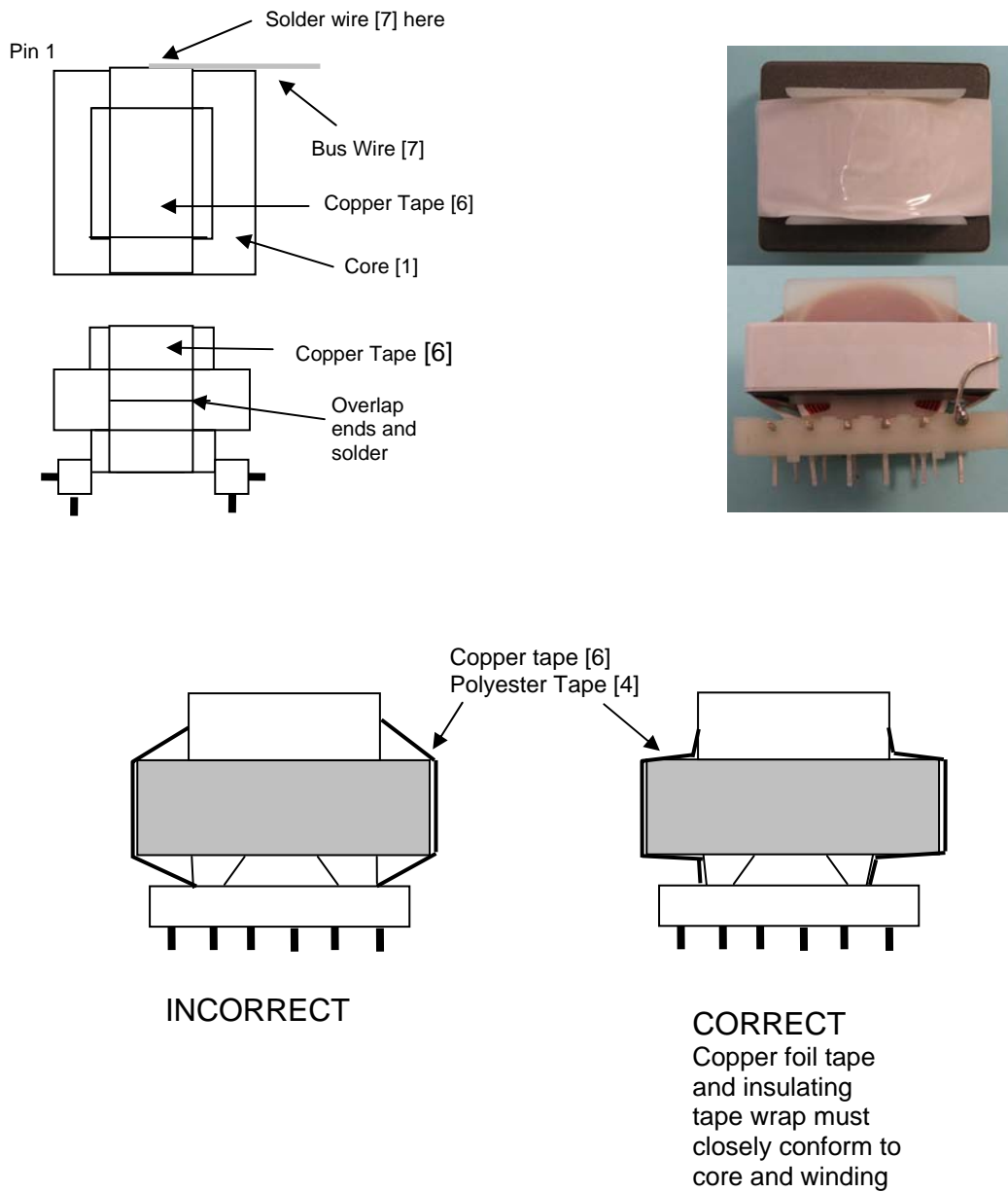

Figure 61 – EE41/33 PFC Choke Build Diagram.



11.5.2.5 Winding Instructions

1	Starting on pin 1, wind 55 quadrifilar turns of wire (item [3]) on bobbin (Item [2]). Finish on pin 6.
2	Use 3 layers of tape (Item [4]) for finish wrap.
3	Assemble bobbin and core halves. Secure core with two wraps of tape (Item 5).
4	Apply 1 turn of copper tape (Item [6]) as shown in Figure 1, centered in bobbin window. Closely conform copper tape to contours of core and winding (see Figure 3). This step is essential for reducing operating noise. Overlap start and finish ends as shown in Figure 1, and solder to form a shorted turn. Take 3cm of hook-up wire (item [7]), solder 1 end of wire to copper foil as shown in Figure 1. Terminate other end on pin 12 of bobbin .
5	Apply 3 turns of tape (item [4]) to insulate copper strap. Closely conform tape wrap to contours of core and winding (see build diagram).
6	Vacuum impregnate and bake finished assembly, cut off pins 7-8

11.5.2.6 Temperature Measurement

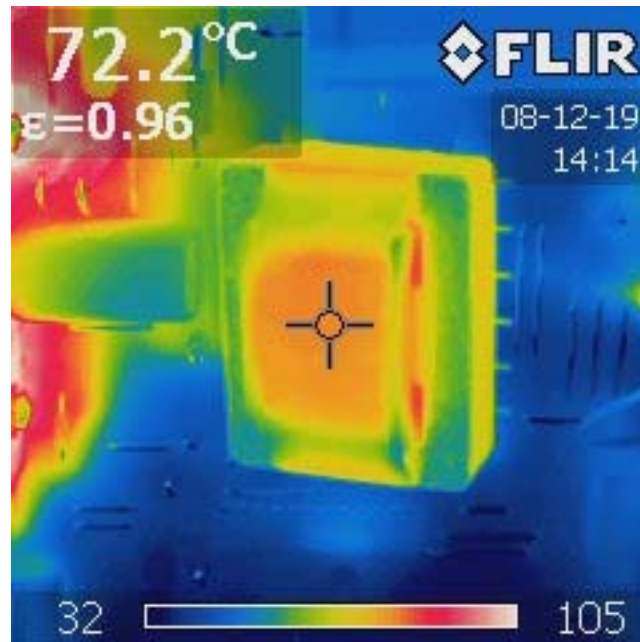

Figure 62 – Temperature Measurement for EE 41/33 PFC Choke
Room Temperature, 90 VAC, 286 W Output Load.

12 LLC Gain-Phase

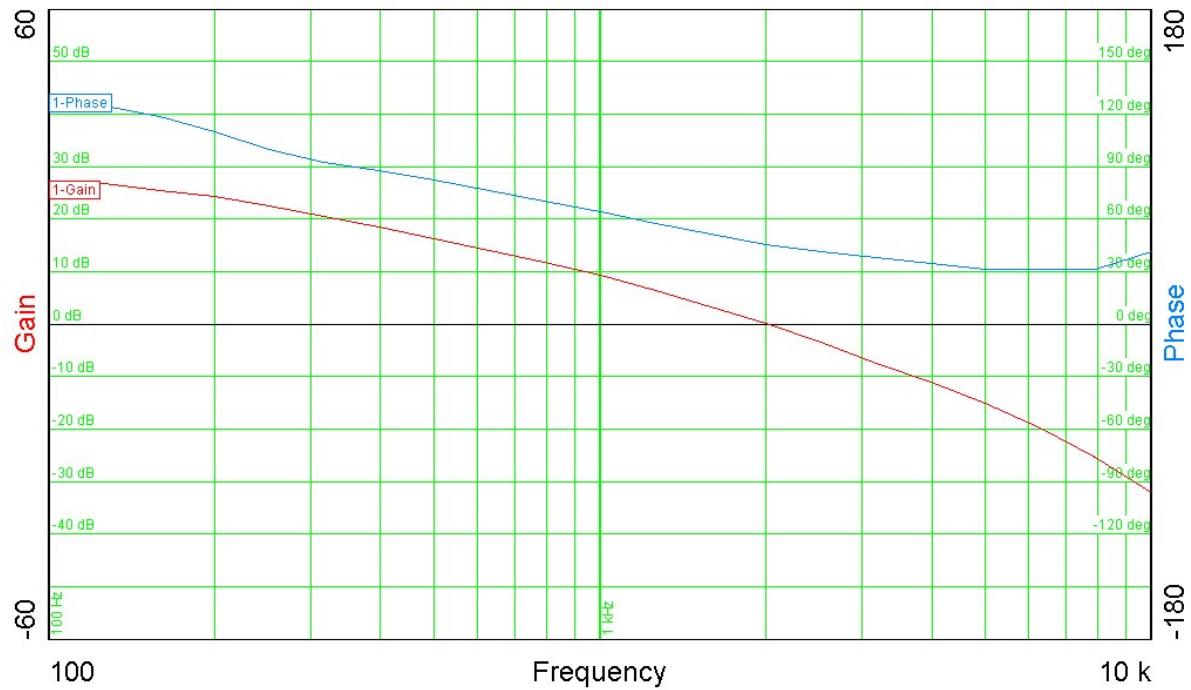

Figure 63 – LLC Converter Gain-Phase, 100% Load Crossover Frequency – 2 kHz, Phase Margin - 45°.

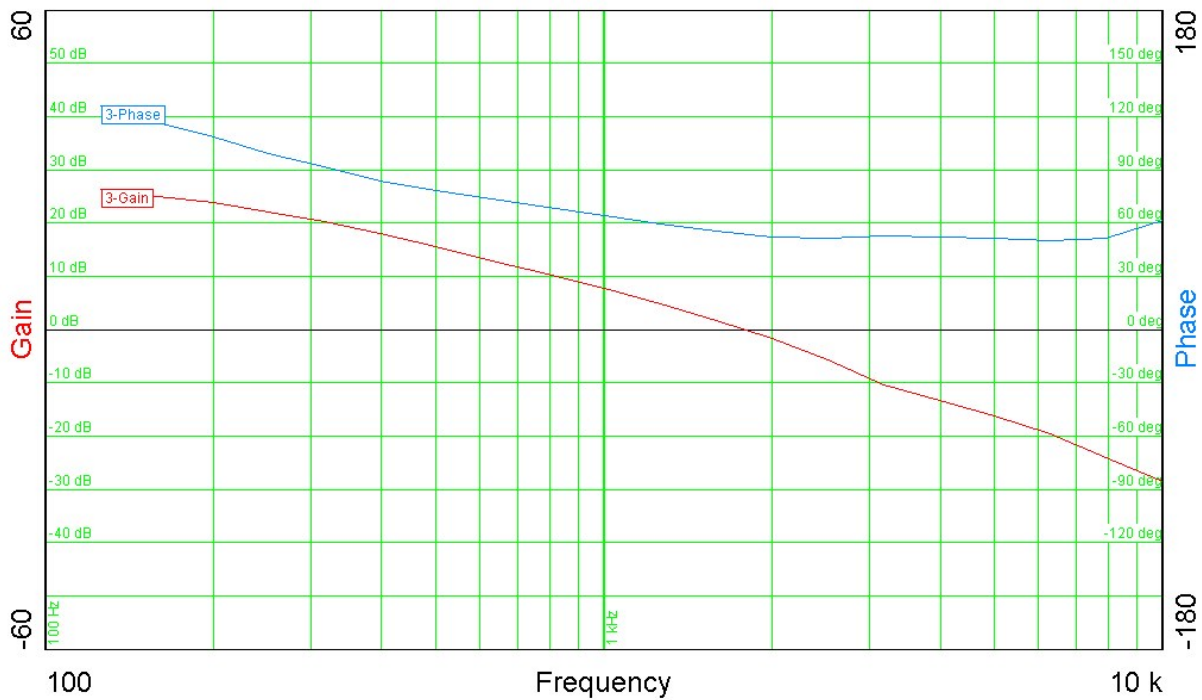

Figure 64 – LLC Converter Gain-Phase, 50% Load. Crossover Frequency ~1.8 kHz, Phase Margin - ~55°.



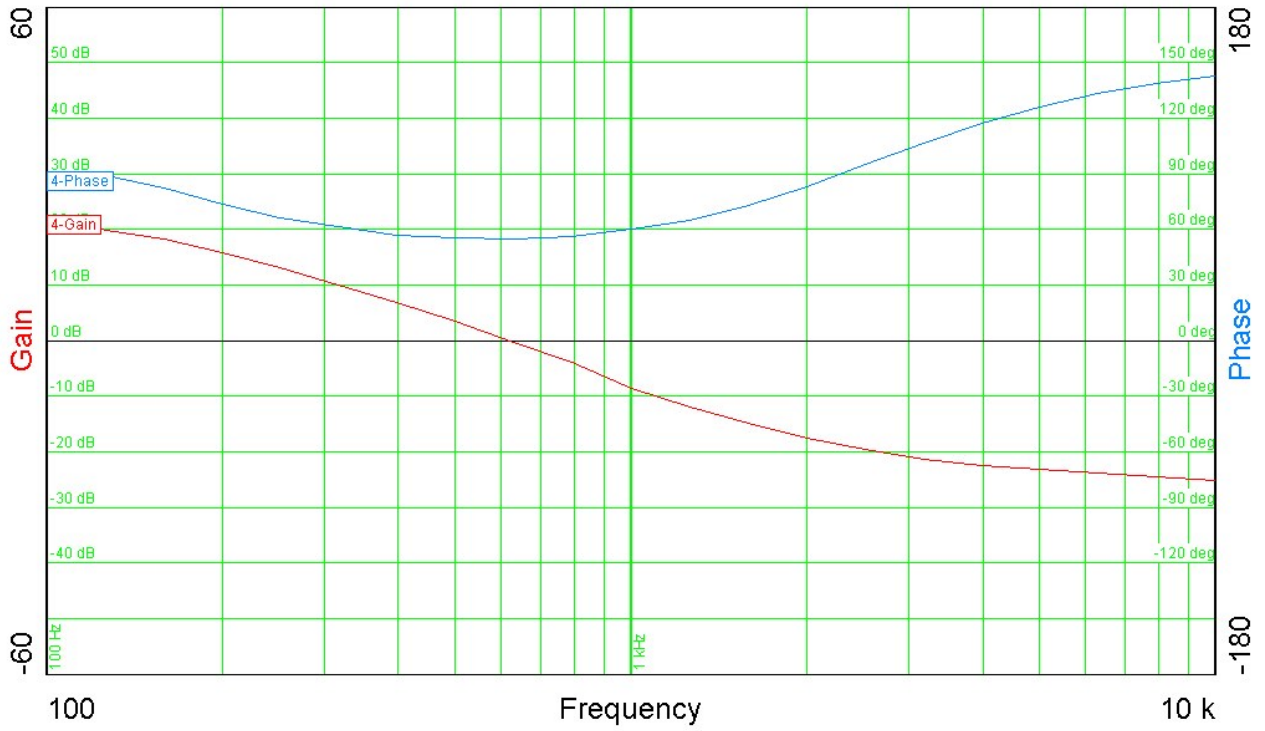

Figure 65 – LLC Converter Gain-Phase, 10% Load. Gain Crossover – 600 Hz, Phase Margin - ~55°.



13 Conducted EMI

Conducted EMI tests were performed with 3 Ω resistive loads on the 12 V and 24 V main outputs, and a 2.5 Ω resistive load on the switched +5 V output (250 W total output power). The board was bolted to a metallic ground plane, which in turn was hard wired to LISN (protective earth) ground.

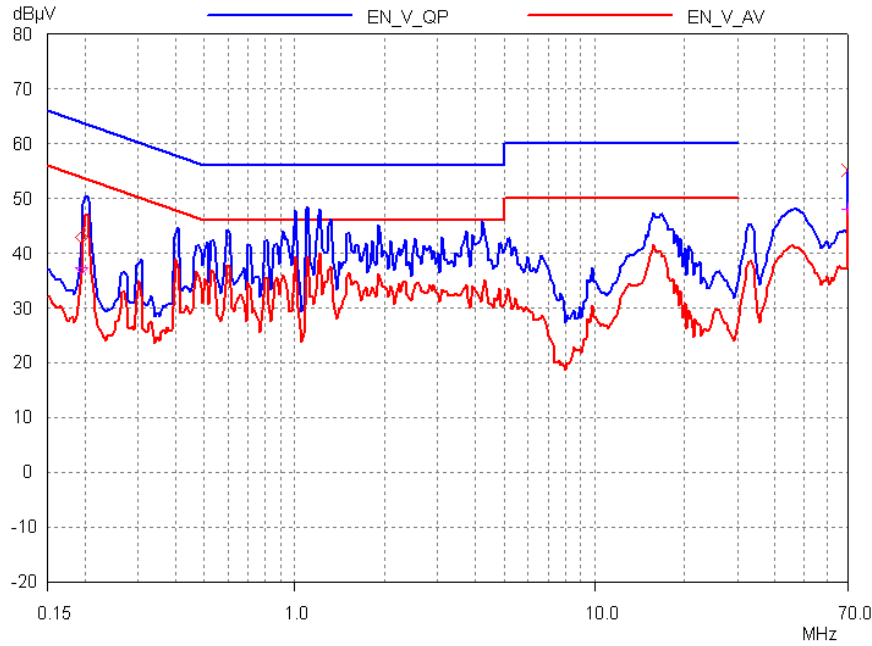

Figure 66 – Conducted EMI. 115 VAC.

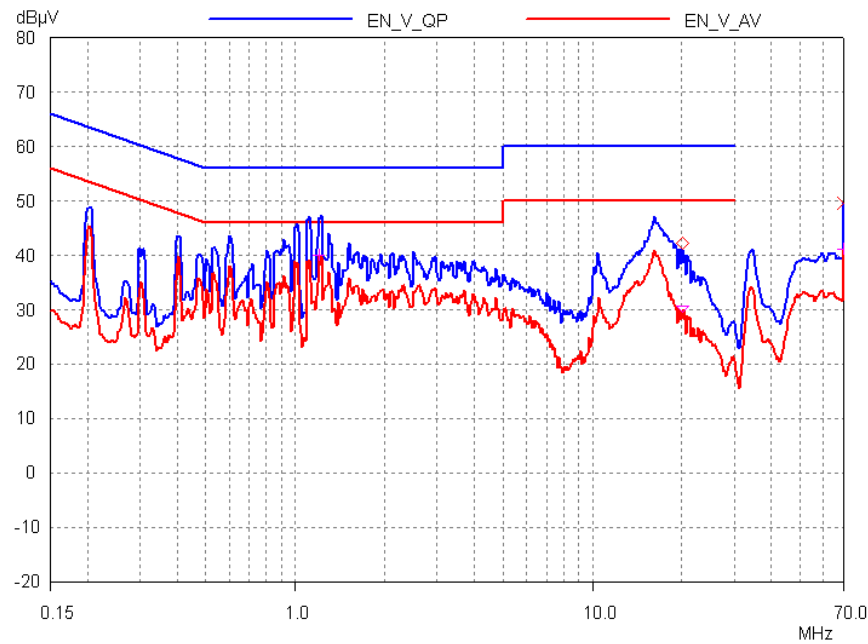

Figure 67 – Conducted EMI, 230 VAC.



14 Line Surge

Differential input line 1.2/50 μ s surge testing was completed on a single test unit to IEC61000-4-5. Input voltage was set at 230 VAC / 60 Hz. Output was loaded at full load and operation was verified following each surge event.

Surge Level (kV)	Generator impedance (Ω)	Input Voltage (VAC)	Injection Location	Injection Phase ($^{\circ}$)	Test Result (Pass/Fail)
+ 2	2	230	L to N	90	Pass
- 2	2	230	L to N	270	Pass
+4	12	230	L,N to G	90	Pass
-4	12	230	L,N to G	270	Pass
+4	12	230	L,N to output return	90	Pass
-4	12	230	L,N to output return	270	Pass

- Notes: 1) A ground plane was placed under the PSU with screws electrically connecting to the PCB standoffs / earth return.
 2) Replace R57 with a small ferrite bead to improve common-mode surge performance to 5.5 kV.



15 Revision History

Date	Author	Revision	Description and changes	Reviewed
29-Jan-09	PV	1.0.1	Initial Release	MKTG, Apps
26-Feb-09	JC	1.0.2	Updated Surge Table, Minor Format Updates	MKTG, Apps
28-Apr-09		1.0.3	Fixed schematic Figure 4 error and Transformer Figure 8 error.	MKTG, Apps
11-Jun-09		1.0.4	Updated Figures 4 and 5.	MKTG, Apps
09-Sep-09	KM	1.05	Fixed BOM errors, formatting issues and updated board pics.	MKTG, Apps



For the latest updates, visit our website: www.powerint.com

Power Integrations reserves the right to make changes to its products at any time to improve reliability or manufacturability. Power Integrations does not assume any liability arising from the use of any device or circuit described herein. POWER INTEGRATIONS MAKES NO WARRANTY HEREIN AND SPECIFICALLY DISCLAIMS ALL WARRANTIES INCLUDING, WITHOUT LIMITATION, THE IMPLIED WARRANTIES OF MERCHANTABILITY, FITNESS FOR A PARTICULAR PURPOSE, AND NON-INFRINGEMENT OF THIRD PARTY RIGHTS.

PATENT INFORMATION

The products and applications illustrated herein (including transformer construction and circuits external to the products) may be covered by one or more U.S. and foreign patents, or potentially by pending U.S. and foreign patent applications assigned to Power Integrations. A complete list of Power Integrations' patents may be found at www.powerint.com. Power Integrations grants its customers a license under certain patent rights as set forth at <http://www.powerint.com/ip.htm>.

The PI Logo, TOPSwitch, TinySwitch, LinkSwitch, DPA-Switch, PeakSwitch, EcoSmart, Clampless, E-Shield, Filterfuse, StackFET, PI Expert and PI FACTS are trademarks of Power Integrations, Inc. Other trademarks are property of their respective companies. ©Copyright 2009 Power Integrations, Inc.

Power Integrations Worldwide Sales Support Locations

WORLD HEADQUARTERS

5245 Hellyer Avenue
San Jose, CA 95138, USA.
Main: +1-408-414-9200
Customer Service:
Phone: +1-408-414-9665
Fax: +1-408-414-9765
e-mail:
usasales@powerint.com

GERMANY

Rueckertstrasse 3
D-80336, Munich
Germany
Phone: +49-89-5527-3911
Fax: +49-89-5527-3920
e-mail:
eurosales@powerint.com

JAPAN

Kosei Dai-3 Bldg.,
2-12-11, Shin-Yokohama,
Kohoku-ku, Yokohama-shi,
Kanagawa 222-0033
Phone: +81-45-471-1021
Fax: +81-45-471-3717
e-mail:
japansales@powerint.com

TAIWAN

5F, No. 318, Nei Hu Rd., Sec. 1
Nei Hu Dist.
Taipei, Taiwan 114, R.O.C.
Phone: +886-2-2659-4570
Fax: +886-2-2659-4550
e-mail:
taiwansales@powerint.com

CHINA (SHANGHAI)

Rm 1601/1610, Tower 1,
Kerry Everbright City
No. 218 Tianmu Road West,
Shanghai, P.R.C. 200070
Phone: +86-21-6354-6323
Fax: +86-21-6354-6325
e-mail:
chinasales@powerint.com

INDIA

#1, 14th Main Road
Vasanthanagar
Bangalore-560052 India
Phone: +91-80-41138020
Fax: +91-80-41138023
e-mail:
indiasales@powerint.com

KOREA

RM 602, 6FL
Korea City Air Terminal B/D,
159-6
Samsung-Dong, Kangnam-Gu,
Seoul, 135-728, Korea
Phone: +82-2-2016-6610
Fax: +82-2-2016-6630
e-mail:
koreasales@powerint.com

UNITED KINGDOM

1st Floor, St. James's House
East Street, Farnham
Surrey, GU9 7TJ
United Kingdom
Phone: +44 (0) 1252-730-141
Fax: +44 (0) 1252-727-689
e-mail:
eurosales@powerint.com

CHINA (SHENZHEN)

Rm A, B & C 4th Floor, Block
C, Electronics Science and
Technology Building, 2070
Shennan Zhong Rd,
Shenzhen, Guangdong,
China, 518031
Phone: +86-755-8379-3243
Fax: +86-755-8379-5828
e-mail:
chinasales@powerint.com

ITALY

Via De Amicis 2
20091 Bresso MI – Italy
Phone: +39-028-928-6000
Fax: +39-028-928-6009
e-mail:
eurosales@powerint.com

SINGAPORE

51 Newton Road,
#15-08/10 Goldhill Plaza,
Singapore, 308900
Phone: +65-6358-2160
Fax: +65-6358-2015
e-mail:
singaporesales@powerint.com

APPLICATIONS HOTLINE

World Wide +1-408-414-9660

APPLICATIONS FAX

World Wide +1-408-414-9760

