

[About Samsung Electronics Co., Ltd.](#)

Samsung Electronics Co. Ltd inspires the world and shapes the future with transformative ideas and technologies. The company is redefining the worlds of TVs, smartphones, wearable devices, tablets, digital appliances, network systems, and semiconductor and LED solutions. For the latest news, please visit the Samsung Newsroom at <http://news.samsung.com>.

Copyright © 2019 Samsung Electronics Co., Ltd. All rights reserved.  
Samsung Electronics reserves the right to modify, at its sole discretion, the design, packaging, specifications, and features shown herein without notice at any time.

Samsung Electronics Co., Ltd.  
Samsung-ro 1, Giheung-gu, Yongin-si,  
Gyeonggi-do, 17113 Korea

[www.samsungled.com](http://www.samsungled.com)

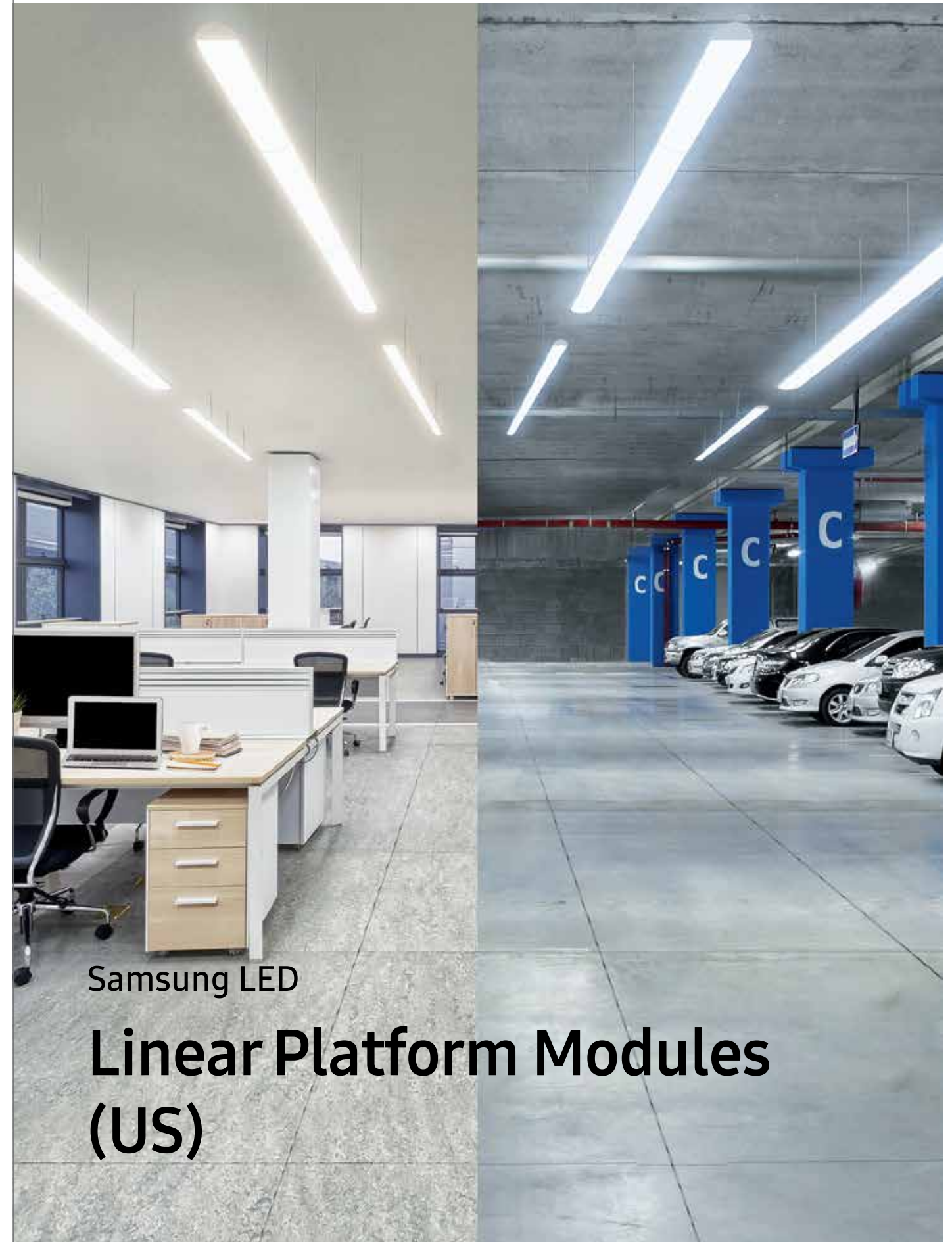

Samsung LED

# Linear Platform Modules (US)

# Indoor Linear Light

With their modular construction, easy-to-use connections and optimal color consistency, Samsung's linear module line-ups are well-suited for a wide variety of luminaires.

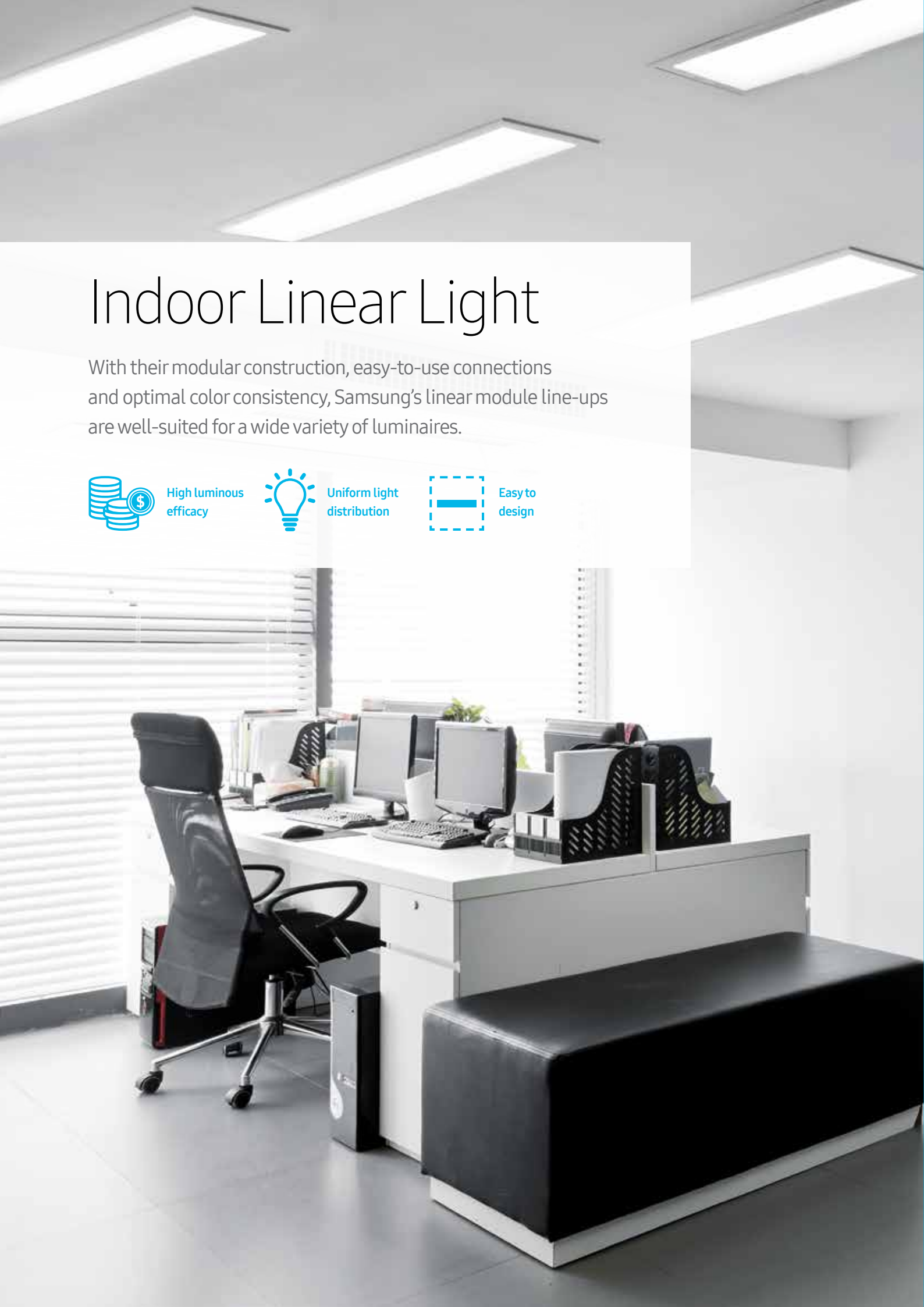

## A wide range of lighting solutions

- Much design flexibility for achieving desired lumen and efficacy levels through the use of narrow modular platforms

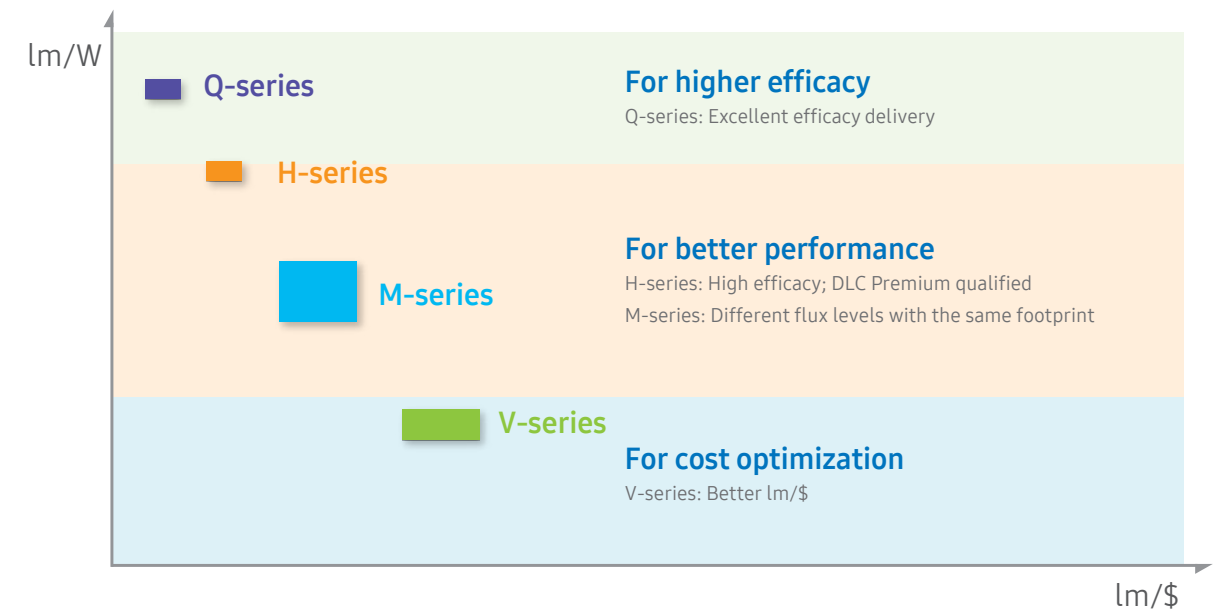

## Greater design flexibility

- Platform designed to easily switch modules between luminaires for the desired lumen output

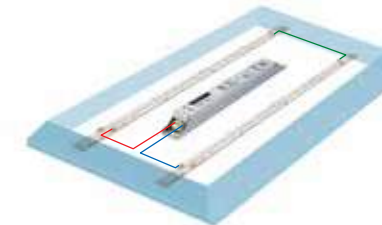

- Narrow width to fit into T5

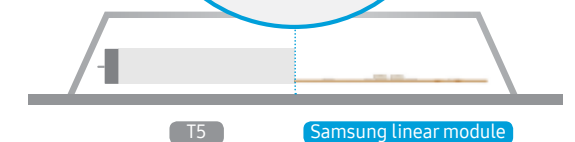
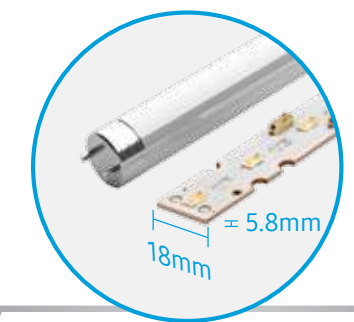

- 18mm: Same width with T5
- 5.8mm: Smaller height

	[ Module ]	[ Fixture ]
Q562A	2000 lm & 203 lm/W	1700 lm & 148 lm/W
H562D	2020 lm & 187 lm/W	1720 lm & 137 lm/W
M562C	2775 lm & 165 lm/W	2360 lm & 121 lm/W
V562C	2460 lm & 146 lm/W	2090 lm & 107 lm/W
Q562A	4000 lm & 203 lm/W	3400 lm & 148 lm/W
H562D	4040 lm & 187 lm/W	3440 lm & 137 lm/W
M562C	5550 lm & 165 lm/W	4720 lm & 121 lm/W
V562C	4920 lm & 146 lm/W	4180 lm & 107 lm/W

• Assumed as Optic 86%, Driver 88%

# Line-up

Product	Key Features	Efficacy (lm/W)	Lifespan
 Q-series	<ul style="list-style-type: none"> <li>• Highest performance</li> <li>• 203lm/W [4000K, CRI 80+, Tp 40°C]</li> </ul>	●●●●●	●●●●●
 H-series	<ul style="list-style-type: none"> <li>• High performance</li> <li>• 187lm/W [4000K, CRI 80+, Tp 40°C]</li> </ul>	●●●●○	●●●●○
 M-series	<ul style="list-style-type: none"> <li>• Flexible design choices</li> <li>• High efficacy up to 165lm/W @4000K</li> </ul>	●●●○	●●●○
 V-series	<ul style="list-style-type: none"> <li>• Value solution</li> <li>• 146lm/W [4000K, CRI80+, Tp 50°C]</li> </ul>	●●●○	●●●○
 T-series	<ul style="list-style-type: none"> <li>• White tunable solution with color temperatures from 2700K to 6500K</li> </ul>	●●○○○	●●○○○

Model	Length			CRI		CCT					
	4ft	2ft	1ft	80+	90+	2700	3000	3500	4000	5000	6500
Q-series	●	●	●	●			●	●	●	●	
H-series	●	●	●	●			●	●	●	●	
M-series	●	●	●	●	●	●	●	●	●	●	
V-series	●	●	●	●			●	●	●	●	
T-series		●	●	●		●	●	●	●	●	●

## T-series



Product	Luminous Flux (lm)	Power Consumption (W)	Input Voltage (V)	IF (mA)	Imax (mA)	Efficacy (lm/W)	CRI	CCT (K)	Beam Angle (°)	Size (mm)	Temperature Range (°C)	Life time (hrs)	Certification	Part Number
LT-T562C	1900	13.5	18.0 / 0	750 / 0	-	141	80+	2700	115	560x18x5.5	-20~+50	50000	cUL, UL	SI-B8A131560WW
	2075	12.6	16.7 / 16.7	375 / 375	-	165	80+	4000	115	560x18x5.5	-20~+50	50000	cUL, UL	SI-B8A131560WW
	2060	13.5	0 / 18.0	0 / 750	-	153	80+	6500	115	560x18x5.5	-20~+50	50000	cUL, UL	SI-B8A131560WW
LT-T282C	950	6.8	9.0 / 0	750 / 0	-	141	80+	2700	115	275x18x5.5	-20~+50	50000	cUL, UL	SI-B8A071280WW
	1040	6.3	8.4 / 8.4	375 / 375	-	165	80+	4000	115	275x18x5.5	-20~+50	50000	cUL, UL	SI-B8A071280WW
	1030	6.8	0 / 9.0	0 / 750	-	153	80+	6500	115	275x18x5.5	-20~+50	50000	cUL, UL	SI-B8A071280WW

## Q-series



Product	Luminous Flux (lm)	Power Consumption (W)	Input Voltage (V)	IF (mA)	Imax (mA)	Efficacy (lm/W)	CRI	CCT (K)	Beam Angle (°)	Size (mm)	Temperature Range (°C)	Life time (hrs)	Certification	Part Number
LT-QB22A	3680	19.7	43.8	450	900	187	80+	3000	115	1120x18x5.2	-20~+50	50000	cUL, UL	SI-B8V201B20US
	3900					3500		SI-B8U201B20US						
	4000					4000		SI-B8T201B20US						
	4100					5000		SI-B8R201B20US						
LT-Q562A	1840	9.9	21.9	450	900	187	80+	3000	115	560x18x5.8	-20~+50	50000	cUL, UL	SI-B8V101560US
	1950					3500		SI-B8U101560US						
	2000					4000		SI-B8T101560US						
	2050					5000		SI-B8R101560US						
LT-Q282A	920	4.9	10.9	450	900	187	80+	3000	115	275x18x5.8	-20~+50	50000	cUL, UL	SI-B8V051280US
	975					3500		SI-B8U051280US						
	1000					4000		SI-B8T051280US						
	1025					5000		SI-B8R051280US						

## H-series

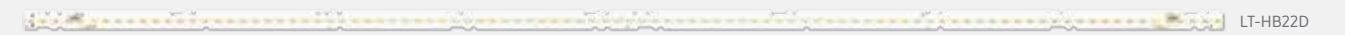

Product	Luminous Flux (lm)	Power Consumption (W)	Input Voltage (V)	IF (mA)	Imax (mA)	Efficacy (lm/W)	CRI	CCT (K)	Beam Angle (°)	Size (mm)	Temperature Range (°C)	Life time (hrs)	Certification	Part Number
LT-HB22D	3870	21.6	22.5	960	2400	179	80+	3000	115	1120x18x5.8	-20~+50	50000	cUL, UL	SI-B8V221B2HUS
	3925					3500		SI-B8U221B2HUS						
	4040					4000		SI-B8T221B2HUS						
	4040					5000		SI-B8R221B2HUS						
LT-H562D	1935	10.8	22.5	480	1200	179	80+	3000	115	560x18x5.8	-20~+50	50000	cUL, UL	SI-B8V11156HUS
	1965					3500		SI-B8U11156HUS						
	2020					4000		SI-B8T11156HUS						
	2020					5000		SI-B8R11156HUS						
LT-H282D	970	5.4	22.5	240	600	180	80+	3000	115	275x18x5.8	-20~+50	50000	cUL, UL	SI-B8V05128HUS
	980					3500		SI-B8U05128HUS						
	1010					4000		SI-B8T05128HUS						
	1010					5000		SI-B8R05128HUS						



# M-series

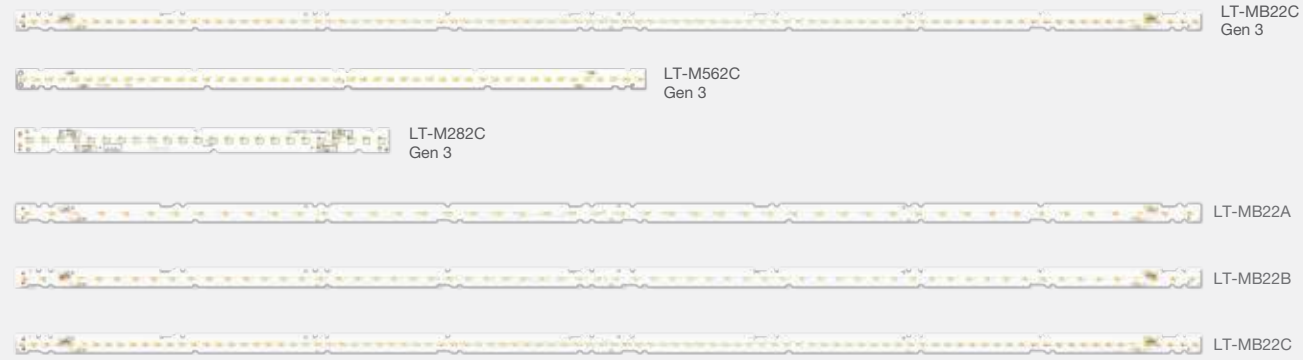

Product	Luminous Flux (lm)	Power Consumption (W)	Input Voltage (V)	IF (mA)	Imax (mA)	Efficacy (lm/W)	CRI	CCT (K)	Beam Angle (°)	Size (mm)	Temperature Range (°C)	Life time (hrs)	Certification	Part Number
LT-MB22C Gen 3	5330	33.6	24	1400	2160	159	80+	3000	115	1120x18x5.2	-20~+50	50000	cUL, UL	SI-B8V341B2001
	5400					161		3500						SI-B8U341B2001
	5550					165		4000						SI-B8T341B2001
	5550					165		5000						SI-B8R341B2001
LT-M562C Gen 3	2665	16.8	24	700	1080	159	80+	3000	115	560x18x5.8	-20~+50	50000	cUL, UL	SI-B8V17256001
	2700					161		3500						SI-B8U17256001
	2775					165		4000						SI-B8T17256001
	2775					165		5000						SI-B8R17256001
LT-M282C Gen 3	1660	11.2	24.8	450	540	149	80+	3000	115	275x18x5.8	-20~+50	50000	cUL, UL	SI-B8V11428001
	1680					151		3500						SI-B8U11428001
	1730					155		4000						SI-B8T11428001
	1730					155		5000						SI-B8R11428001
LT-MB22A	3160	22.3	24.8	900	1080	142	80+	3000	115	1120x18x5.2	-20~+50	50000	cUL, UL	SI-B8V221B20WW
	3210					144		3500						SI-B8U221B20WW
	3300					148		4000						SI-B8T221B20WW
	3300					148		5000						SI-B8R221B20WW
LT-MB22B	4210	29.8	24.8	1200	1440	141	80+	3000	115	1120x18x5.2	-20~+50	50000	cUL, UL	SI-B8V301B20WW
	4280					144		3500						SI-B8U301B20WW
	4400					148		4000						SI-B8T301B20WW
	4400					148		5000						SI-B8R301B20WW
LT-MB22C	5070	33.6	24.0	1400	2160	151	80+	3000	115	1120x18x5.2	-20~+50	50000	cUL, UL	SI-B8V341B20WW
	5150					153		3500						SI-B8U341B20WW
	5310					158		4000						SI-B8T341B20WW
	5310					158		5000						SI-B8R341B20WW



Product	Luminous Flux (lm)	Power Consumption (W)	Input Voltage (V)	IF (mA)	Imax (mA)	Efficacy (lm/W)	CRI	CCT (K)	Beam Angle (°)	Size (mm)	Temperature Range (°C)	Life time (hrs)	Certification	Part Number
LT-M562A Gen 2	1580	11.2	24.8	450	540	141	80+	3000	115	560x18x5.8	-20~+50	50000	CE cUL, UL	SI-B8V113560WW
	1605					144		3500						SI-B8U113560WW
	1650					148		4000						SI-B8T113560WW
	1650					148		5000						SI-B8R113560WW
LT-M562B Gen 2	2105	14.9	24.8	600	720	141	80+	3000	115	560x18x5.8	-20~+50	50000	CE cUL, UL	SI-B8V152560WW
	2140					144		3500						SI-B8U152560WW
	2200					148		4000						SI-B8T152560WW
	2200					148		5000						SI-B8R152560WW
LT-M562C Gen 2	2535	16.8	24.0	700	1080	151	80+	3000	115	560x18x5.8	-20~+50	50000	CE cUL, UL	SI-B8V172560WW
	2575					153		3500						SI-B8U172560WW
	2655					158		4000						SI-B8T172560WW
	2655					158		5000						SI-B8R172560WW
LT-M282A Gen 2	790	5.6	12.4	450	540	142	80+	3000	115	275x18x5.8	-20~+50	50000	CE cUL, UL	SI-B8V052280WW
	800					143		3500						SI-B8U052280WW
	825					148		4000						SI-B8T052280WW
	825					148		5000						SI-B8R052280WW
LT-M282B Gen 2	1050	7.4	24.8	300	360	142	80+	3000	115	275x18x5.8	-20~+50	50000	CE cUL, UL	SI-B8V072280WW
	1070					144		3500						SI-B8U072280WW
	1100					148		4000						SI-B8T072280WW
	1100					148		5000						SI-B8R072280WW
LT-M282C Gen 2	1580	11.2	24.8	450	540	142	80+	3000	115	275x18x5.8	-20~+50	50000	CE cUL, UL	SI-B8V114280WW
	1605					144		3500						SI-B8U114280WW
	1650					148		4000						SI-B8T114280WW
	1650					148		5000						SI-B8R114280WW
LT-M562F	1205	11.2	24.8	450	540	108	90+	2700	115	560x18x5.8	-20~+50	50000	cUL, UL	SI-B9W111560WW
	1225					110		3000						SI-B9V111560WW
	1250					112		3500						SI-B9U111560WW
	1300					116		4000						SI-B9T111560WW
LT-M562G	1605	14.9	24.8	600	720	108	90+	2700	115	560x18x5.8	-20~+50	50000	cUL, UL	SI-B9W151560WW
	1635					110		3000						SI-B9V151560WW
	1670					112		3500						SI-B9U151560WW
	1730					116		4000						SI-B9T151560WW
LT-M562H	1935	16.8	24.0	700	1080	115	90+	2700	115	560x18x5.8	-20~+50	50000	cUL, UL	SI-B9W171560WW
	1970					117		3000						SI-B9V171560WW
	2010					120		3500						SI-B9U171560WW
	2085					124		4000						SI-B9T171560WW
LT-M272F	600	5.6	12.4	450	540	108	90+	2700	115	275x18x5.8	-20~+50	50000	cUL, UL	SI-B9W051280WW
	615					110		3000						SI-B9V051280WW
	625					112		3500						SI-B9U051280WW
	650					116		4000						SI-B9T051280WW
LT-M272G	800	7.4	24.8	300	360	108	90+	2700	115	275x18x5.8	-20~+50	50000	cUL, UL	SI-B9W071280WW
	820					110		3000						SI-B9V071280WW
	835					112		3500						SI-B9U071280WW
	865					116		4000						SI-B9T071280WW
LT-M272H	1205	11.2	24.8	450	540	108	90+	2700	115	275x18x5.8	-20~+50	50000	cUL, UL	SI-B9W113280WW
	1225					110		3000						SI-B9V113280WW
	1250					112		3500						SI-B9U113280WW
	1300					116		4000						SI-B9T113280WW

# V-series



Product	Luminous Flux (lm)	Power Consumption (W)	Input Voltage (V)	IF (mA)	Imax (mA)	Efficacy (lm/W)	CRI	CCT (K)	Beam Angle (°)	Size (mm)	Temperature Range (°C)	Life time (hrs)	Certification	Part Number
LT-VB22F	8300	52.1	46.5	1120	1350	159	80+	3000	115	1120x18x5.5	-30~+50	50000	cUL, UL	SI-B8V522B2CUS
	8410					161		3500						SI-B8U522B2CUS
	8690					167		4000						SI-B8T522B2CUS
	8800					169		5000						SI-B8R522B2CUS
LT-V562F	4150	26.1	23.3	1120	1350	159	80+	3000	115	560x18x5.5	-30~+50	50000	cUL, UL	SI-B8V26256CUS
	4205					161		3500						SI-B8U26256CUS
	4345					167		4000						SI-B8T26256CUS
	4400					169		5000						SI-B8R26256CUS
LT-V564F	8300	52.1	46.5	1120	1350	159	80+	3000	115	560x39.8x5.5	-30~+50	50000	cUL, UL	SI-B8V52256CUS
	8410					161		3500						SI-B8U52256CUS
	8690					167		4000						SI-B8T52256CUS
	8800					169		5000						SI-B8R52256CUS
LT-VB22C	5360	32.5	46.4	700	900	165	80+	3000	115	1120x18x5.5	-30~+50	50000	cUL, UL	SI-B8V342B2CUS
	5440					167		3500						SI-B8U342B2CUS
	5620					173		4000						SI-B8T342B2CUS
	5690					175		5000						SI-B8R342B2CUS
LT-V562C	2680	16.2	23.2	700	900	165	80+	3000	115	560x18x5.5	-30~+50	50000	cUL, UL	SI-B8V17256CWW
	2720					167		3500						SI-B8U17256CWW
	2810					173		4000						SI-B8T17256CWW
	2845					175		5000						SI-B8R17256CWW

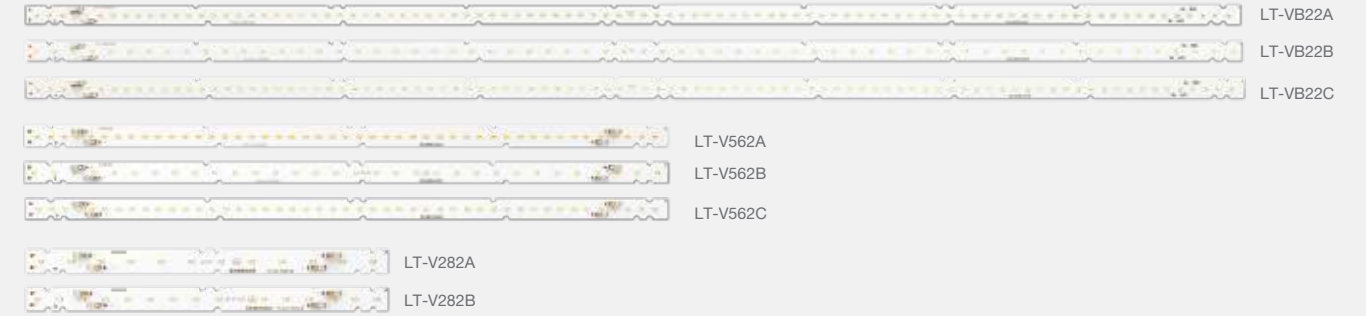

Product	Luminous Flux (lm)	Power Consumption (W)	Input Voltage (V)	IF (mA)	Imax (mA)	Efficacy (lm/W)	CRI	CCT (K)	Beam Angle (°)	Size (mm)	Temperature Range (°C)	Life time (hrs)	Certification	Part Number
LT-VB22A	2696	21.2	25.2	840	1080	127	80+	3000	115	1120x18x5.5	-20~+50	50000	cUL, UL	SI-B8V221B2CUS
	2800					132		3500						SI-B8U221B2CUS
	2904					137		4000						SI-B8T221B2CUS
	2904					137		5000						SI-B8R221B2CUS
LT-VB22B	4090	32.0	25.4	1260	1440	128	80+	3000	115	1120x18x5.5	-20~+50	50000	cUL, UL	SI-B8V301B2CUS
	4218					132		3500						SI-B8U301B2CUS
	4314					135		4000						SI-B8T301B2CUS
	4314					135		5000						SI-B8R301B2CUS
LT-VB22C	4540	33.6	48.0	700	1080	135	80+	3000	115	1120x18x5.5	-20~+50	50000	cUL, UL	SI-B8V341B2CUS
	4738					141		3500						SI-B8U341B2CUS
	4920					146		4000						SI-B8T341B2CUS
	4920					146		5000						SI-B8R341B2CUS
LT-V562A	1348	10.6	25.2	420	540	127	80+	3000	115	560x18x5.5	-20~+50	50000	cUL, UL	SI-B8V11156CWW
	1400					132		3500						SI-B8U11156CWW
	1452					137		4000						SI-B8T11156CWW
	1452					137		5000						SI-B8R11156CWW
LT-V562B	2045	16.0	25.4	630	720	128	80+	3000	115	560x18x5.5	-20~+50	50000	cUL, UL	SI-B8V15156CWW
	2109					132		3500						SI-B8U15156CWW
	2157					135		4000						SI-B8T15156CWW
	2157					135		5000						SI-B8R15156CWW
LT-V562C	2270	16.8	24.0	700	1080	135	80+	3000	115	560x18x5.5	-20~+50	50000	cUL, UL	SI-B8V17156CWW
	2369					141		3500						SI-B8U17156CWW
	2460					146		4000						SI-B8T17156CWW
	2460					146		5000						SI-B8R17156CWW
LT-V282A	724	5.7	12.6	450	540	128	80+	3000	115	275x18x5.5	-20~+50	50000	cUL, UL	SI-B8V06128CWW
	746					132		3500						SI-B8U06128CWW
	769					136		4000						SI-B8T06128CWW
	769					136		5000						SI-B8R06128CWW
LT-V282B	965	7.6	25.2	300	360	128	80+	3000	115	275x18x5.5	-20~+50	50000	cUL, UL	SI-B8V08128CWW
	995					132		3500						SI-B8U08128CWW
	1026					136		4000						SI-B8T08128CWW
	1026					136		5000						SI-B8R08128CWW



# Driver



SI-CU1023001WW / SI-CU1023002WW



SI-CU1625001US / SI-CU1625002US



SI-EPF006660WW



SI-EPF007040WW

Part Number	Power Consumption (W)	Size (mm)	Input Voltage (V)	Output Voltage (V)	Output Current/ch (mA)	Efficiency (%)	THD (%)	Dimming	Certification	Power Factor	Remark
SI-CU1023001WW	30	300 x 30 x 21	120-277	14-54	350-800	87	<20	0-10V	Class P, cUL, UL, Type TL	>0.9	Output current adjustable by Rset, 1% - 100% Dimming
SI-CU1023002WW											
SI-CU1625001US	50	300 x 30 x 21	120-277	15-54	700-1600	87	<20	0-10V	Class P, cUL, UL, Type TL	>0.9	Output current adjustable by Programming, 1% - 100% Dimming
SI-CU1625002US											
SI-EPF006660WW	50	300 x 30 x 21	120-277	20-50	500-1400	88	<20	0-10V	cUL, UL	>0.9	Output current adjustable by Rset
SI-EPF007040WW	75	359 x 30 x 26.5		22-52	1000-2100						



SLP-DUA43501US



SLP-DUA45501US



SLP-DUA47501US



SLP-DUA435D1US



SLP-DUA455D1US



SLP-DUA475D1US

Part Number	Power Consumption (W)	Size (mm)	Input Voltage (V)	Output Voltage (V)	Output Current/ch (mA)	Efficiency (%)	THD (%)	Dimming	Certification	Power Factor	Remark
SLP-DUA43501US	35	270 x 33 x 25	120-277	10-50	350-1400	88	<20	0-10V	cUL, UL	>0.90	Programmable Native White Tuning Dim to warm Auxiliary Power (24V)
SLP-DUA45501US	55	300 x 33 x 25									
SLP-DUA47501US	75	330 x 33 x 30									
SLP-DUA435D1US	35	270 x 33 x 25	120-277	10-50	350-1400	88	<20	DALI	cUL, UL	>0.90	Programmable Device Type 8 Auxiliary Power (24V)
SLP-DUA455D1US	55	300 x 33 x 25									
SLP-DUA475D1US	75	330 x 33 x 30									



SLP-DUA47531WW

Part Number	Power Consumption (W)	Size (mm)	Input Voltage (V)	Output Voltage (V)	Output Current/ch (mA)	Efficiency (%)	THD (%)	Dimming	Certification	Power Factor	Remark
SLP-DUA47531WW	75	330 x 30 x 30	120-277	10-50	350-1400	88	<20	0-10V, DALI	CE, cUL, UL	>0.90	Programmable Native White Tuning Device Type 8 Auxiliary Power (24V)

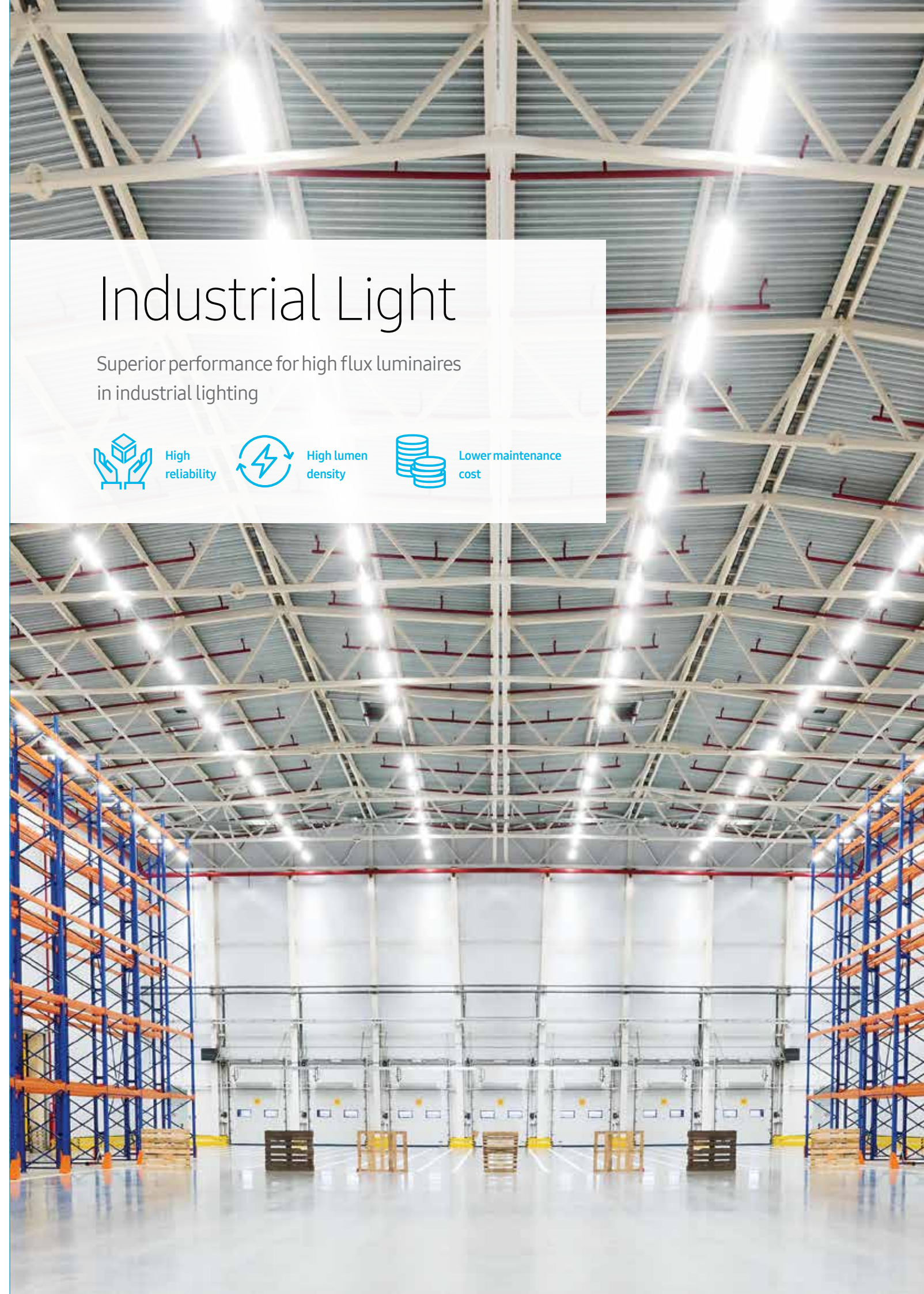

# Industrial Light

Superior performance for high flux luminaires in industrial lighting



High reliability



High lumen density



Lower maintenance cost



## Diverse module designs offering great freedom of design

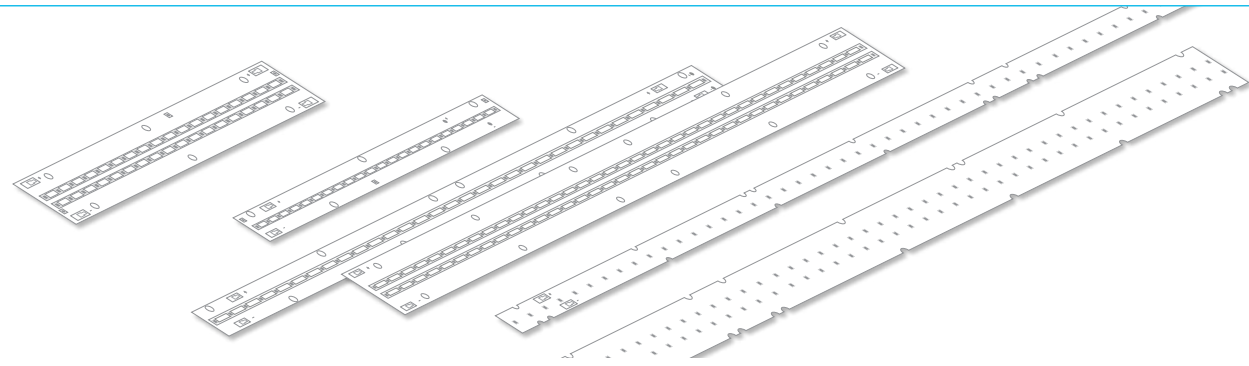

## Wide lumen flux coverage (up to 40,000lm) H inFlux

Optimized for industrial lighting applications to replace T8/T5HO

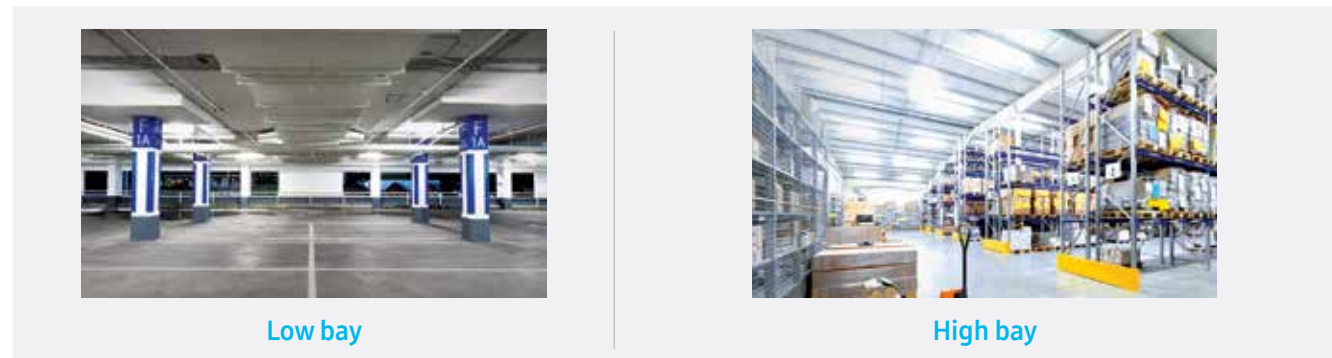

Lamp	2 lamps T8 32W	3 lamps T8 32W	4 lamps T8 32W	1 lamps T5 54W	2 lamps T5 54W	3 lamps T5 54W	4 lamps T5 54W	8 lamps T5 54W
Lamp Flux	5,400-5,600	7,800-8,400	10,400-11,200	4,450-5,000	8,900-10,000	13,350-15,000	17,800-20,000	35,600-40,000
<b>H inFlux</b>	L06 (1ea)	L04 (2ea) L09 (1ea)	L06 (2ea)	L04 (1ea)	L04 (2ea) L09 (1ea)	L06 (2ea)	L09 (2ea)	L09 (4ea)

## Line-up

Product	Key Features	Efficacy (lm/W)	Lifespan
H inFlux	<ul style="list-style-type: none"> <li>Wide lumen flux coverage - up to 40,000lm by combining modules</li> <li>Highest performance</li> <li>192lm/W [4000K, CRI 80+, Tp 55°C]</li> </ul>	●●●●●	●●●●●
F-series	<ul style="list-style-type: none"> <li>High lumen density of 18,600lm to replace tubes in high/low bay lighting</li> <li>Flexible design choices</li> <li>High efficacy - up to 175lm/W @4000K</li> </ul>	●●●●○	●●●●○
V-series F-type	<ul style="list-style-type: none"> <li>Value solution</li> <li>146lm/W [4000K, CRI80+, Tp 50°C]</li> </ul>	●●○○○	●●○○○

Model	Length			CRI		CCT					
	4ft	2ft	1ft	80+	90+	2700	3000	3500	4000	5000	6500
H inFlux	●	●	●	●			●	●	●	●	
F-series	●	●	●	●			●	●	●	●	
V-series F-type	●	●	●	●			●	●	●	●	

## H inFlux



Product	Luminous Flux (lm)	Power Consumption (W)	Input Voltage (V)	IF (mA)	I <sub>max</sub> (mA)	Efficacy (lm/W)	CRI	CCT (K)	Beam Angle (°)	Size (mm)	Temperature Range (°C)	Life time (hrs)	Certification	Part Number
H inFlux_L04	3960	22.3	22.3	1000	1380	178	80+	3000	120	560x24x5.9	-40~+50	50000	CE, cUL, UL	SL-B8V2N80LAWW
	4060					182		3500						SL-B8U2N80LAWW
	4280					192		4000						SL-B8T2N80LAWW
	4280					192		5000						SL-B8R2N80LAWW
H inFlux_L06	5630	32.0	22.4	1430	950	176	80+	3000	120	560x24x5.9	-40~+50	50000	CE, cUL, UL	SL-B8V3N80LAWW
	5800					181		3500						SL-B8U3N80LAWW
	6110					191		4000						SL-B8T3N80LAWW
	6110					191		5000						SL-B8R3N80LAWW
H inFlux_L09	7910	44.6	44.6	1000	1380	177	80+	3000	120	561x41x5.9	-40~+50	50000	CE, cUL, UL	SL-B8V4N90LAWW
	8130					182		3500						SL-B8U4N90LAWW
	8570					192		4000						SL-B8T4N90LAWW
	8570					192		5000						SL-B8R4N90LAWW
H inFlux_S02	1980	11.1	11.1	1000	1380	178	80+	3000	120	280x24x5.9	-40~+50	50000	CE, cUL, UL	SL-B8V1N30LAWW
	2030					183		3500						SL-B8U1N30LAWW
	2140					193		4000						SL-B8T1N30LAWW
	2140					193		5000						SL-B8R1N30LAWW
H inFlux_S03	2820	16.0	11.2	1430	950	176	80+	3000	120	280x24x5.9	-40~+50	50000	CE, cUL, UL	SL-B8V1N60LAWW
	2890					180		3500						SL-B8U1N60LAWW
	3060					191		4000						SL-B8T1N60LAWW
	3060					191		5000						SL-B8R1N60LAWW
H inFlux_S04	3960	22.3	22.3	1000	1380	178	80+	3000	120	281x41x5.9	-40~+50	50000	CE, cUL, UL	SL-B8V2N70LAWW
	4060					182		3500						SL-B8U2N70LAWW
	4280					192		4000						SL-B8T2N70LAWW
	4280					192		5000						SL-B8R2N70LAWW

# F-series

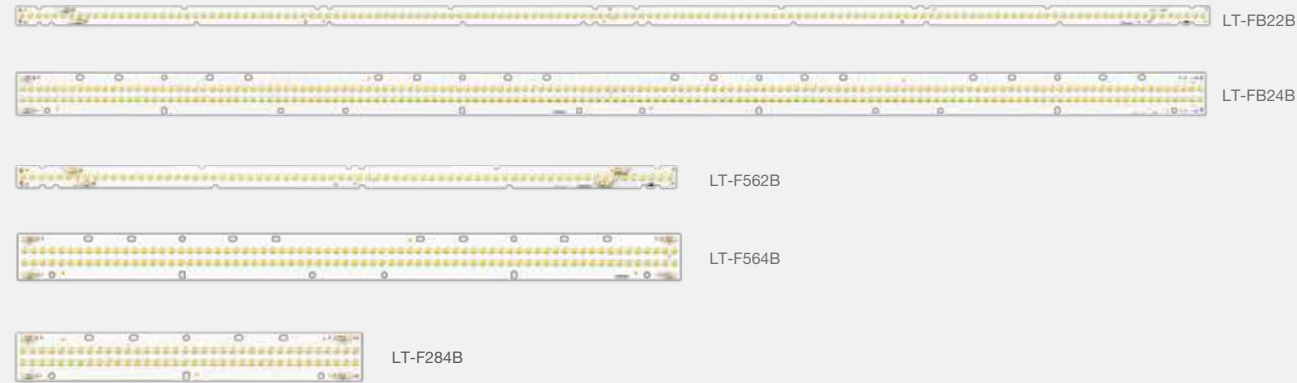

Product	Luminous Flux (lm)	Power Consumption (W)	Input Voltage (V)	IF (mA)	I <sub>max</sub> (mA)	Efficacy (lm/W)	CRI	CCT (K)	Beam Angle (°)	Size (mm)	Temperature Range (°C)	Life time (hrs)	Certification	Part Number
LT-FB22B	8670	51.5	46.0	1120	1800	168	80+	3000	115	1120x18x5.2	-30~+55	50000	cUL, UL	SI-B8V521B20WW
	8800					171		3500						SI-B8U521B20WW
	9000					175		4000						SI-B8T521B20WW
	9300					181		5000						SI-B8R521B20WW
LT-FB24B	17340	103.0	46.0	2240	3600	168	80+	3000	115	1120x39.8x5.2	-30~+55	50000	cUL, UL	SI-B8VZ91B20WW
	17600					171		3500						SI-B8UZ91B20WW
	18000					175		4000						SI-B8TZ91B20WW
	18600					181		5000						SI-B8RZ91B20WW
LT-F562B	4335	25.8	23.0	1120	1800	168	80+	3000	115	560x18x5.2	-30~+55	50000	cUL, UL	SI-B8V261560WW
	4400					171		3500						SI-B8U261560WW
	4500					175		4000						SI-B8T261560WW
	4650					181		5000						SI-B8R261560WW
LT-F564B	8670	51.5	46.0	1120	1800	168	80+	3000	115	559.7x39.8x5.2	-30~+55	50000	cUL, UL	SI-B8V521560WW
	8800					171		3500						SI-B8U521560WW
	9000					175		4000						SI-B8T521560WW
	9300					181		5000						SI-B8R521560WW
LT-F284B	4335	25.8	23.0	1120	1800	168	80+	3000	115	280x40x5.2	-30~+55	50000	cUL, UL	SI-B8V261280WW
	4400					171		3500						SI-B8U261280WW
	4500					175		4000						SI-B8T261280WW
	4650					181		5000						SI-B8R261280WW

# V-series F-type

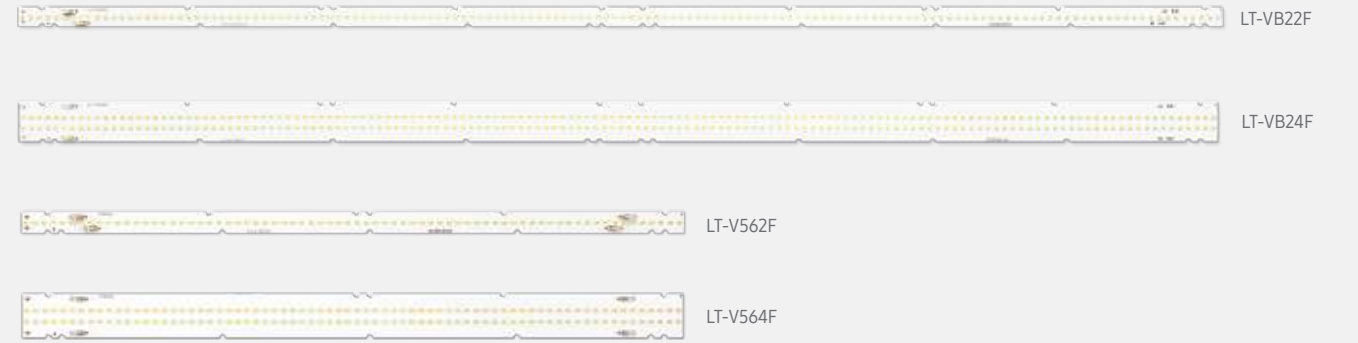

Product	Luminous Flux (lm)	Power Consumption (W)	Input Voltage (V)	IF (mA)	I <sub>max</sub> (mA)	Efficacy (lm/W)	CRI	CCT (K)	Beam Angle (°)	Size (mm)	Temperature Range (°C)	Life time (hrs)	Certification	Part Number
LT-VB22F	7214	54.7	48.8	1120	1620	132	80+	3000	115	1120x18x5.5	-30~+50	50000	cUL, UL	SI-B8V521B2CUS
	7488					137		3500						SI-B8U521B2CUS
	7816					143		4000						SI-B8T521B2CUS
	816					143		5000						SI-B8R521B2CUS
LT-VB24F	14428	109.3	48.8	2240	3240	132	80+	3000	115	1120x39.8x5.5	-30~+50	50000	cUL, UL	SI-B8VZ91B2CUS
	14976					137		3500						SI-B8UZ91B2CUS
	15632					143		4000						SI-B8TZ91B2CUS
	15632					143		5000						SI-B8RZ91B2CUS
LT-V562F	3607	27.3	24.4	1120	1620	132	80+	3000	115	560x18x5.5	-30~+50	50000	cUL, UL	SI-B8V26156CUS
	3744					137		3500						SI-B8U26156CUS
	3908					143		4000						SI-B8T26156CUS
	3908					143		5000						SI-B8R26156CUS
LT-V564F	7214	54.7	48.8	1120	1620	132	80+	3000	115	560x39.8x5.5	-30~+50	50000	cUL, UL	SI-B8V52156CUS
	7488					137		3500						SI-B8U52156CUS
	7816					143		4000						SI-B8T52156CUS
	816					143		5000						SI-B8R52156CUS

# Driver



SI-CA1427501US



SI-CA2029601US

Part Number	Power Consumption (W)	Size (mm)	Input Voltage (V)	Output Voltage (V)	Output Current/ch (mA)	Efficiency (%)	THD (%)	Dimming	Certification	Power Factor	Remark
SI-CA1427501US	75	360 x 31 x 26	100-277	27-54	975-1400	88	<20	0-10V	cUL, UL	>0.9	Programmable Output Current, 5% - 100% Dimming
SI-CA2029601US	100	420 x 31 x 26		24-48	1400-2000						