

CMX901 Broadband Efficient RF Power Amplifier

Features

- **Wide operating frequency range**
130MHz to 950MHz
- **Typical output power:**
 - 2.5W operating at 160MHz
 - 1.8W operating at 435MHz
 - 1.5W operating at 915MHz
- **High power gain 40dB**
- **High power added efficiency**
up to 60% at VHF
- **Single polarity supply voltage**
2.5V to 6V
- **Small 28 pin WQFN package**

Applications

- **Wireless data communications**
FSK, FFSK/MSK, GFSK/GMSK, Multi-level FSK
- **Analogue FM handheld radio terminals**
- **Marine AIS Class-B and Marine AIS-SART**
- **RFID readers/writers**
- **Automatic meter reading (AMR)**
- **Wireless sensor networks**
Mesh/Ad hoc systems
- **Remote control and sensing systems**
- **Commercial and consumer communications**

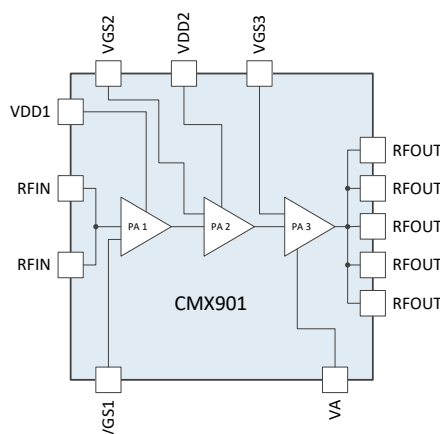

1 Brief Description

The CMX901 is a three stage high-gain and high efficiency RF power amplifier. The device is ideally suited for use in VHF and UHF frequency bands up to 950MHz.

The first and second stages of the amplifier operate in a class-A and class-AB mode respectively, and the third stage operates in a class-C mode for maximum efficiency.

External components are required to match the device input and output ports to 50 Ohms. The CMX901 is available in a small footprint 5mm x 5mm, low thermal resistance 28-pin WQFN package making it ideal for small form factor applications such as data modules as well as handheld radio terminals.

CONTENTS

<u>Section</u>	<u>Page</u>
1	Brief Description..... 1
1.1	History 3
2	Block Diagram 3
3	Performance Specification 4
3.1	Electrical Performance 4
3.1.1	Absolute Maximum Ratings 4
3.1.2	Operating Limits 4
3.1.3	Operating Characteristics 5
3.2	Typical Performance..... 6
3.2.1	Operation at 160MHz 6
3.2.2	Operation at 435MHz 7
3.2.3	Operation at 915MHz 8
4	Pin and Signal Definitions 9
4.1	Pin List 9
4.2	Signal Definitions 10
5	Application Information 11
5.1	General Description 11
5.2	Main Characteristics 11
5.2.1	Input Impedance 11
5.2.2	Thermal Design 12
6	General Application Schematic 13
7	PCB Layout 14
8	Application Notes 14
8.1	Output Power Control 14
8.1.1	TDMA Operation 14
9	Packaging 15
9.1	Ordering 15
<u>Table</u>	<u>Page</u>
Table 1	S-parameter data (S_{11}), $V_{DD} = 4V$, $V_{gs1} = 1.65V$, $V_{gs2} = 1.35V$ and $V_{gs3} = 0.93V$, $I_{ds} = 18mA$ 12
Table 2a	Recommended External Components (variations with frequency) 14
<u>Figure</u>	<u>Page</u>
Figure 1	CMX901 Block Diagram 3
Figure 2	Input power to output power characteristic, $V_{DD} = 4V$ 6
Figure 3	Variation of output power with temperature, $V_{DD} = 4V$, $V_{PARAMP} = 3.3V$, input level = -5dBm 6
Figure 4	Output power vs. control voltage characteristics and variation with temperature, $V_{DD} = 4V$, input level = -5dBm 6
Figure 5	Output power and efficiency variation with temperature, $V_{DD} = 4V$, input level = -5dBm, $V_{PARAMP} = 3.3V$ 6
Figure 6	Input power to output power characteristic, $V_{DD} = 4V$ at 435MHz 7
Figure 7	Variation in output power with temperature, $V_{DD} = 4V$, $V_{PARAMP} = 3.3V$, input level = -10dBm 7
Figure 8	Output power vs. control voltage characteristics variation with temperature, $V_{DD} = 4V$, input level = -10dBm 7
Figure 9	Output power and efficiency variation with temperature, $V_{DD} = 4V$, input level = -10dBm, $V_{PARAMP} = 3.3V$ 7
Figure 10	Input power to output power characteristic, $V_{DD} = 4V$ at 915MHz 8
Figure 11	Variation in output power with temperature, $V_{DD} = 4V$, $V_{PARAMP} = 3.3V$, input level = 0dBm 8
Figure 12	Output power vs. control voltage characteristics variation with temperature, $V_{DD} = 4V$, input level = 0dBm 8
Figure 13	Output power and efficiency variation with temperature, $V_{DD} = 4V$, input level = 0dBm, $V_{PARAMP} = 3.3V$ 8
Figure 14	Pin Configuration 9
Figure 15	S_{11} response, $V_{DD} = 4V$, $V_{gs1} = 1.65V$, $V_{gs2} = 1.35V$ and $V_{gs3} = 0.93V$, $I_{ds} = 18mA$ 11
Figure 16	CMX901 Recommended External Components 13
Figure 17	QT8 Mechanical Outline 15

1.1 History

Version	Changes	Date
7	Document front page rebranded as part of the CML SμRF product launch	22 nd March 2021
6	Section 3.1.3.1: addition to table describing enhanced input power range condition for stability performance at 160 MHz.	22 nd April 2020
5	R2 = 200 Ohms for VHF applications	9 th August 2019
4	Section 3: Thermal data added Section 5.2.2: Thermal Design added Datasheet changed to Provisional status	19 th July 2017
3	Section 5.2.1: Updated s-parameter data in Table 1	9 th February 2017
2	First public release	7 th February 2017
1	Internal release	January 2017

This is Provisional Information; changes and additions may be made to this specification. Parameters marked TBD or left blank will be included in later issues.

2 Block Diagram

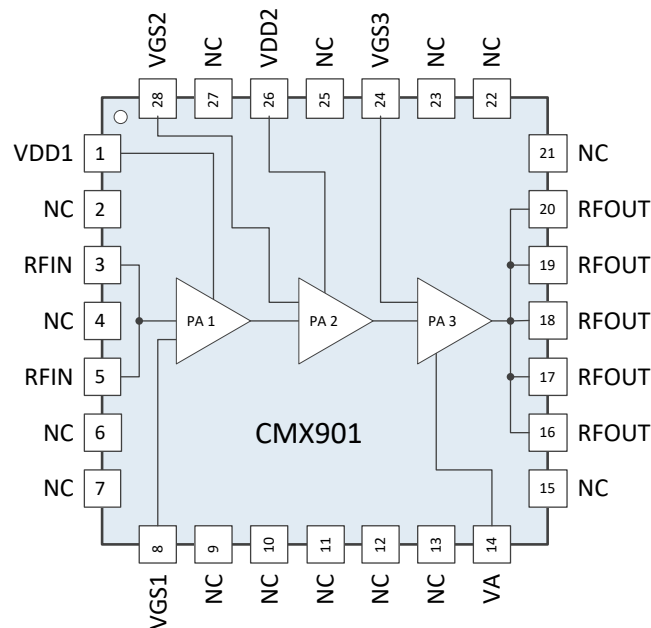

Figure 1 CMX901 Block Diagram

3 Performance Specification

3.1 Electrical Performance

3.1.1 Absolute Maximum Ratings

Exceeding these maximum ratings can result in damage to the device.

	Notes	Min.	Max.	Unit
Supply: $V_{DD} - V_{SS}$	1	-0.5	12.0	V
$I_{DD} - I_{SS}$	2		2.2	A
RF power at input pin	1		15	dBm
Output load VSWR			10:1	
RF Power per pin			30	dBm

Notes

1. Transient and not operational i.e. Vgs1, Vgs2 and Vgs3 set to 0V
2. Rating for peak or continuous operation

QT8 Package (28-pin WQFN)	Notes	Min.	Max.	Unit
Storage Temperature		-50	+125	°C

3.1.2 Operating Limits

Correct operation of the device outside these limits is not implied.

	Notes	Min.	Max.	Unit
Supply Voltage:				
$V_{DD} - V_{SS}$		2.5	6	V
$V_{GS} - V_{SS}$ (per stage)			2.5	V
Operating Air Temperature (T_{AMB})		-40	+85	°C
Maximum Allowable Junction Temperature			+125	°C
Maximum Continuous Power Dissipation (P_{DISS})	3, 4		1.8	W

Notes

3. Dependent on PCB layout arrangements and heatsinking, see section 5.2.2.
4. $P_{DISS} = P_{DC} - P_{OUT}$, where: $P_{DC} = V_{DD} \times I_{DD}$ and P_{OUT} = measured RF output power.

3.1.3 Operating Characteristics

For the following conditions unless otherwise specified: External components as recommended in Figure 16, $V_{DD} = 4.0V$

$T_{AMB} = 25^{\circ}C$, $V_{BIAS} = 3.3V$

Specification	Min.	Typ.	Max.	Unit	Condition
RF Frequency Range	130	-	950	MHz	
Quiescent Current (from V_{DD})	-	-	1	μA	$V_{BIAS} = V_{PARAMP} = 0V$
Thermal Resistance R_{JC} (junction to central heatsink ground pad)	-	2.5	3	$^{\circ}C/W$	

3.1.3.1 Operating Characteristics 160MHz

RF frequency = 160MHz, RF power input = -5dBm, $V_{PARAMP} = 3.3V$

Specification	Min.	Typ.	Max.	Unit	Condition
Maximum output power (Pmax160)	-	2.5	-	W	Pin = -5dBm
Power added efficiency	-	61	-	%	Pout = 2.5W, $V_{DD} = 4V$
Input power for Pmax160	-	-5	-	dBm	$V_{DD} = 4V$
Gain	-	39	-	dB	Pin = -5dBm
	-	45	-	dB	Pin = -15dBm
Second harmonic	-	-23	-	dBc	Pmax 160
Third harmonic	-	-37	-	dBc	Pmax 160
Fourth harmonic	-	-54	-	dBc	Pmax 160
Other non-harmonic spurious	-	-	-75	dBc	Pmax 160
Input VSWR	-	See s_{11} data	-		See section 5.2.1
Stability, VSWR 5:1		Stable all phases, continuous or pulsed operation, power output variation with load phase +1,-4 dB (typ.)			Variation from normal output power with 50 Ω load and with input power (Pin) between -15 dBm and 0 dBm.
Open circuit, Short circuit		No damage			Continuous operation for 30 seconds

3.1.3.2 Operating Characteristics 435MHz

RF frequency = 435MHz, RF power input = -10dBm, $V_{PARAMP} = 3.3V$

Specification	Min.	Typ.	Max.	Unit	Condition
Maximum output power (Pmax435)	-	1.8	-	W	Pin = -5dBm
Power added efficiency	-	52	-	%	Pout = 1.8W, $V_{DD} = 4V$
Input power for Pmax435	-	-10	-	dBm	$V_{DD} = 4V$
Gain	-	42.5	-	dB	
ACPR	-	-	-70	dBc	EN 300 086, 25kHz channel
Reverse Isolation	-	-60	-	dB	Pmax 435
Second harmonic	-	-30	-	dBc	Pmax 435
Third harmonic	-	-52	-	dBc	Pmax 435
Fourth harmonic	-	-46	-	dBc	Pmax 435
Other non-harmonic spurious	-	-	-75	dBc	Pmax 435
Input VSWR	-	See s_{11} data	-		See section 5.2.1
Stability, VSWR 5:1		Stable all phases, continuous operation, power output variation with load phase $\pm 2dB$ (typ.)			

Open circuit, Short circuit	No damage	Continuous operation for 30 seconds
-----------------------------	-----------	-------------------------------------

3.1.3.3 Operating Characteristics 915MHz

RF frequency = 915MHz, RF power input = 0dBm, $V_{PARAMP} = 3.3V$

Specification	Min.	Typ.	Max.	Unit	Condition
Maximum output power (Pmax915)	-	1.5	-	W	$V_{DD} = 4V$
Power added efficiency	-	42	-	%	$P_{out} = 1.5W, V_{DD} = 4V$
Input power for Pmax915	-	0	-	dBm	
Gain	-	32	-	dB	$P_{in} = 0 \text{ dBm}$
	-	31	-	dB	$P_{in} = -10 \text{ dBm}$
Second harmonic	-	-45	-	dBc	Pmax915
Third harmonic	-	-54	-	dBc	Pmax915
Fourth harmonic	-	-52	-	dBc	Pmax915
Other non-harmonic spurious	-	-	-75	dBc	Pmax915
Input VSWR	-	See s_{11} data	-		
Stability, VSWR 3:1	Stable all phases, continuous operation, power output variation with load phase $\pm 2 \text{ dB}$ (typ.)				
Stability, VSWR 10:1	Stable all phases				
Open circuit, Short circuit	No damage				Continuous operation for 30s

3.2 Typical Performance

3.2.1 Operation at 160MHz

Performance data measured using EV9011 PCB, circuit values as Table 2 / Figure 16.

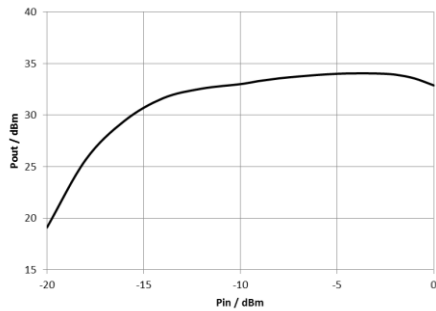

Figure 2 Input power to output power characteristic, $V_{DD} = 4V$

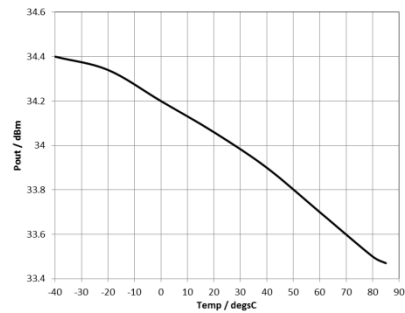

Figure 3 Variation of output power with temperature, $V_{DD} = 4V, V_{PARAMP} = 3.3V$, input level = -5dBm

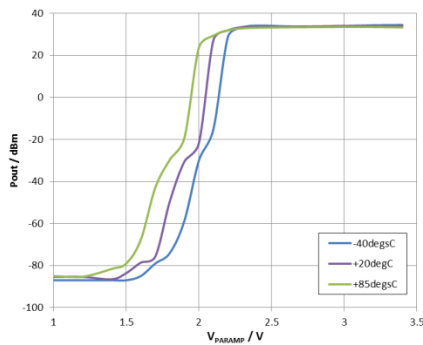

Figure 4 Output power vs. control voltage characteristics and variation with temperature, $V_{DD} = 4V$, input level = -5dBm

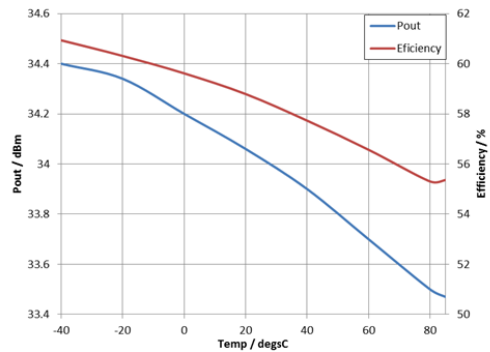

Figure 5 Output power and efficiency variation with temperature, $V_{DD} = 4V$, input level = -5dBm, $V_{PARAMP} = 3.3V$

3.2.2 Operation at 435MHz

Performance data measured using EV9011 PCB, circuit values as Table 2 / Figure 16.

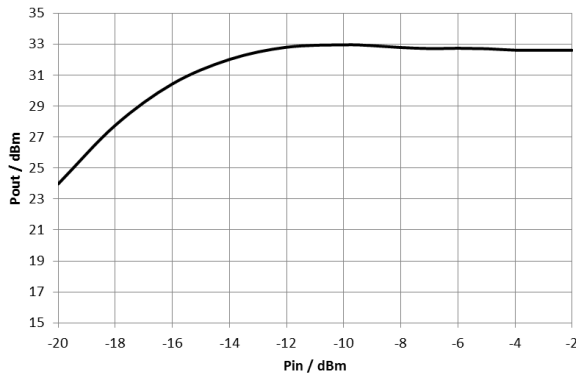

Figure 6 Input power to output power characteristic, $V_{DD} = 4V$ at 435MHz

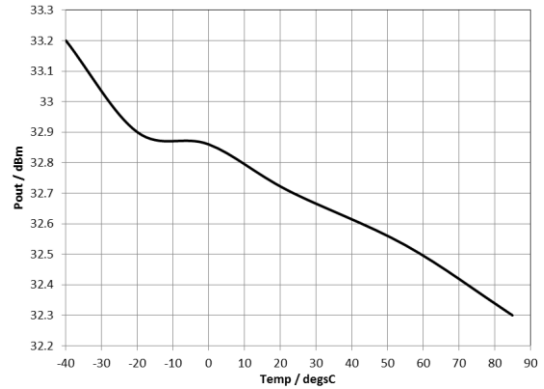

Figure 7 Variation in output power with temperature, $V_{DD} = 4V$, $V_{PARAMP} = 3.3V$, input level = -10dBm

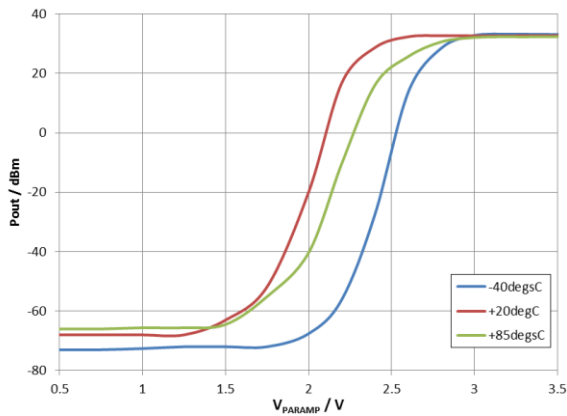

Figure 8 Output power vs. control voltage characteristics variation with temperature, $V_{DD} = 4V$, input level = -10dBm

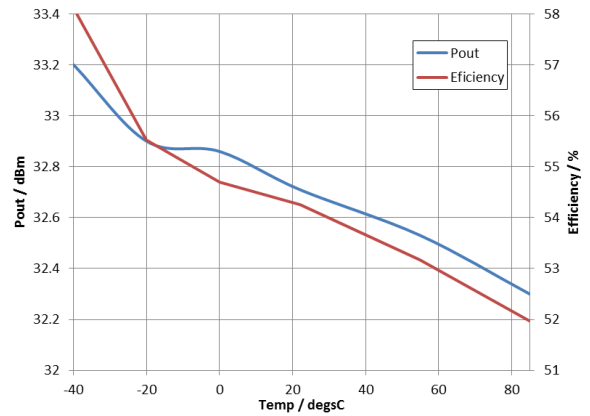

Figure 9 Output power and efficiency variation with temperature, $V_{DD} = 4V$, input level = -10dBm, $V_{PARAMP} = 3.3V$

3.2.3 Operation at 915MHz

Performance data measured using EV9011 PCB, circuit values as Table 2 / Figure 16.

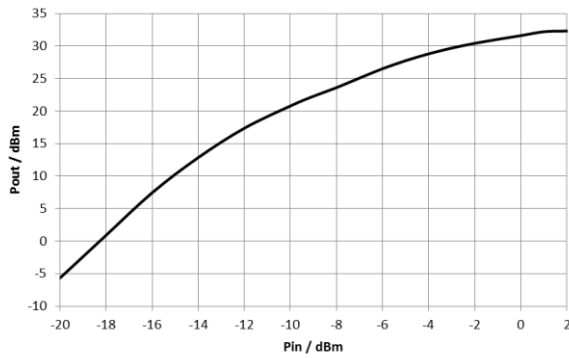

Figure 10 Input power to output power characteristic, $V_{DD} = 4V$ at 915MHz

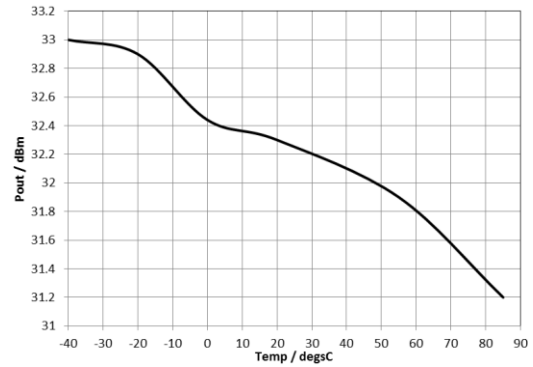

Figure 11 Variation in output power with temperature, $V_{DD} = 4V$, $V_{PARAMP} = 3.3V$, input level = 0dBm

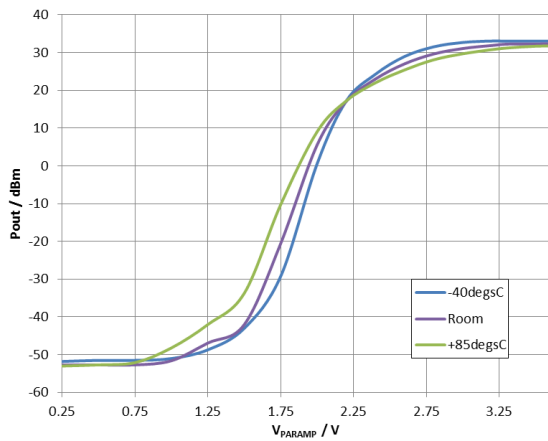

Figure 12 Output power vs. control voltage characteristics variation with temperature, $V_{DD} = 4V$, input level = 0dBm

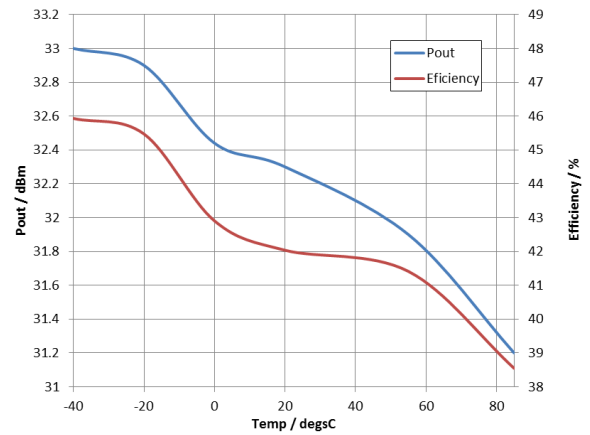

Figure 13 Output power and efficiency variation with temperature, $V_{DD} = 4V$, input level = 0dBm, $V_{PARAMP} = 3.3V$

4 Pin and Signal Definitions

Top View

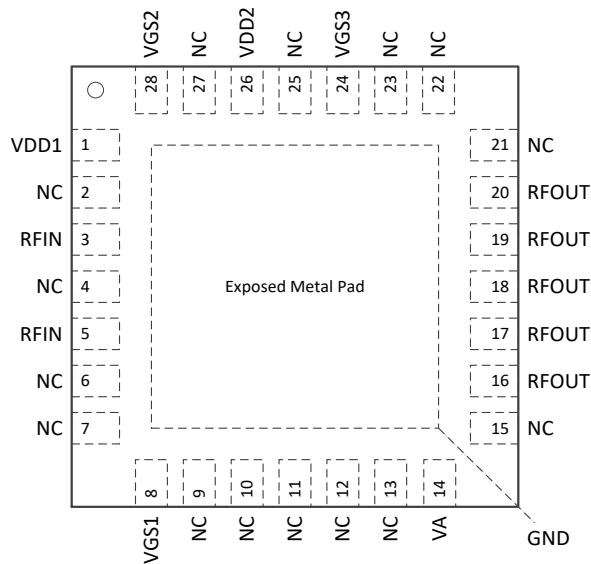

Figure 14 Pin Configuration

4.1 Pin List

Pin No.	Pin Name	Type	Description
1	VDD1	PWR	Power supply for the first stage
2	NC	NC	Connect to GND
3	RFIN	IP	RF signal input (off-chip DC blocking capacitor required)
4	NC	NC	Connect to ground
5	RFIN	IP	As pin 3
6	NC	NC	Connect to GND
7	NC	NC	Connect to GND
8	VGS1	IP	Bias input for first stage
9	NC	NC	Connect to GND
10	NC	NC	Connect to GND
11	NC	NC	Connect to GND
12	NC	NC	Connect to GND
13	NC	NC	Connect to GND
14	VA	PWR	Connect to 3.3V
15	NC	NC	Connect to GND
16	RFOUT	OP	Power supply and RF output
17	RFOUT		
18	RFOUT		
19	RFOUT		
20	RFOUT		
21	NC	NC	Connect to GND
22	NC	NC	Connect to GND
23	NC	NC	Connect to GND
24	VGS3	IP	Bias input for output stage

Pin No.	Pin Name	Type	Description
25	NC	NC	Connect to GND
26	VDD2	PWR	Power supply for second stage
27	NC	NC	Connect to GND
28	VGS2	IP	Bias input for second stage
Exposed Metal Pad	GND	PWR	The central metal pad must be connected to ground.

Notes:

OP = Output PWR = Power Connection
 IP = Input NC = No internal connection

4.2 Signal Definitions

Signal Name	Pins	Usage
V _{DD}	VDD	Power supply
V _{GS1}	VGS1	Bias input for the first amplifier stage
V _{GS2}	VGS2	Bias input for the second amplifier stage
V _{GS3}	VGS3	Bias input for the third amplifier stage
V _{PARAMP}	N/A	Combined control voltage with V _{GS1} V _{GS2} configured as Figure 16 (NB: see also section 8.1).
V _{BIAS}	N/A	Combined control voltage V _{GS3} and pin VA, configured as Figure 16.
V _{SS}	GND	Ground

5 Application Information

5.1 General Description

The CMX901 is a three-stage RF power amplifier producing high gain at full output power. An input power of up to 0dBm is required to achieve fully-saturated output power (0dBm at maximum operating frequency). The device requires only a single positive power supply. The primary ground connection is via a large central pad on the bottom of the package.

The first and second stages of the amplifier operate in class-A and class-AB mode, respectively. The final stage operates in Class-C mode. DC current will increase with RF input signal. The optimum load for maximum output power and efficiency is approximately 5Ω. An external matching network is required to match this impedance to a 50Ω load (see Figure 16). The RFIN pins are DC biased, thus a blocking capacitor is recommended between signal source and the input pins.

Vdd1 and Vdd2 provide DC power supply to the first and second stages, respectively. An RF tuning inductor is needed for each pin. Vgs1, Vgs2 and Vgs3 should be set to different bias voltages for maximum output power and efficiency; see Figure 16 and section 8.1 for further details.

5.2 Main Characteristics

5.2.1 Input Impedance

Typical CMX901 input impedance (S_{11}) is shown in Figure 15 as measured with EV9011 configured for 435MHz operation with a RC network of 470R and 1nF (but no other matching) at the input. The measured S_{11} response varies with inter-stage and output matching configuration. The configuration used for this measurement was the 435MHz circuit values from Figure 16 / Table 2.

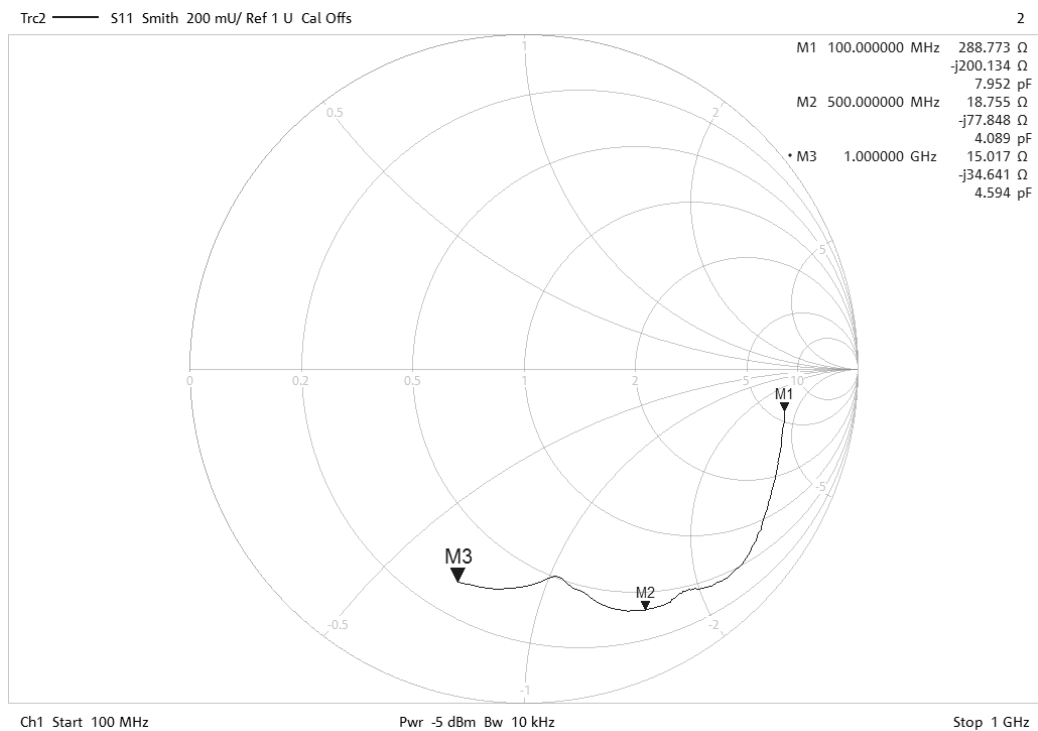

Figure 15 S_{11} response, $V_{DD} = 4V$, $V_{gs1} = 1.65V$, $V_{gs2} = 1.35V$ and $V_{gs3} = 0.93V$, $I_{ds} = 18mA$

Frequency (MHz)	S(1,1) Mag \angle Ang
100	0.796 \angle - 9.537°
150	0.805 \angle - 13.911°
200	0.811 \angle - 18.941°
250	0.825 \angle - 24.26°
300	0.843 \angle - 30.397°
350	0.872 \angle - 38.211°
400	0.859 \angle - 50.154°
450	0.822 \angle - 55.754°
500	0.809 \angle - 63.538°
550	0.747 \angle - 72.205°
600	0.683 \angle - 76.943°
650	0.641 \angle - 80.317°
700	0.628 \angle - 82.409°
750	0.633 \angle - 85.03°
800	0.647 \angle - 89.029°
850	0.657 \angle - 93.691°
900	0.665 \angle - 98.609°
950	0.668 \angle - 103.614°
1000	0.671 \angle - 107.921°

Table 1 S-parameter data (S_{11}), $V_{DD} = 4V$, $V_{gs1} = 1.65V$, $V_{gs2} = 1.35V$ and $V_{gs3} = 0.93V$, $I_{ds} = 18mA$

5.2.2 Thermal Design

The large central pad on the bottom of the package should be electrically and thermally connected to the PCB ground plane, typically with 20-25 vias, a 0.2mm hole size is recommended and the vias must be from top layer to bottom layer. A typical solution is a via pattern based on an inner via diameter of 0.200mm (0.025mm plating of via walls), with 25 vias on a 0.670mm grid pattern; the vias do not need to be filled. The PCB layout should provide a thermal radiator appropriate for the intended operation/duty cycle in order to avoid an excessive junction temperature.

It should be noted that the peak power dissipation may exceed the maximum rated continuous power dissipation (P_{DISS}) when the transmitter is used for discontinuous transmission for example in TDMA transmission systems. In this case average power dissipation should not exceed P_{DISS} .

Frequency (MHz)	L1 (0603CS) (nH)	L2 (0603CS) (nH)	L3 (nH)	L4 (0630CS) (nH)	L5 (nH)	C21 (pF)	C22 (pF)	C10 (pF)	C11 (pF)	C12 (pF)
160	56	56	19	150	12	-	3.3	12	56	5.6
435	27	27	16	43	3.6	5.6	-	4.7	-	18
915	5.6	8.7	6	10	1.8	4.7	-	10	4.7	-

Table 2a Recommended External Components (variations with frequency)

R1	N/F	C1	4.7 μ F	C19	100pF
R2	N/F (Note 4)	C2	Note 1	C20	N/F
R3	680 Ω (Note 2)	C3	1 μ F	C21	Table 2a
R5	68k Ω	C4	Note 1	C22	Table 2a
R6	100k Ω	C5	1 μ F	C23	1nF
R7	68k Ω	C6	Note 1	C24	Note 1
R8	51R	C7	1 μ F	C25	10nF
R9	47k Ω	C8	Note 1	C26	10nF
R10	68k Ω	C9	Note 1		
R11	39k Ω	C10	Table 2a		
		C11	Table 2a		
		C12	Table 2a		

Notes:

1. 470pF but use 47pF at 915MHz
2. 470 Ω recommended at 450MHz
3. All inductors are Coilcraft (www.coilcraft.com)
4. 200 Ω recommended at 160MHz

Table 2b Recommended External Components (common values)

7 PCB Layout

Careful layout of the PCB is essential for best performance. Recommended layout may be taken from evaluation kit EV9011.

8 Application Notes

8.1 Output Power Control

The output power of the CMX901 can be controlled by varying V_{PARAMP} from 0V to 3.3V. This in turn adjusts V_{GS1} and V_{GS2} . It is recommended to connect V_{GS3} , along with VA (pin 14), to 3.3V dc. This gives a satisfactory power control characteristic for TDMA systems like DMR (ETSI standards EN 300 113 and TS 102 361).

8.1.1 TDMA Operation

Careful assessment of device stability is advised during power ramping when operating into non-50 Ω loads, especially at operating frequencies of 400MHz and above.

9 Packaging

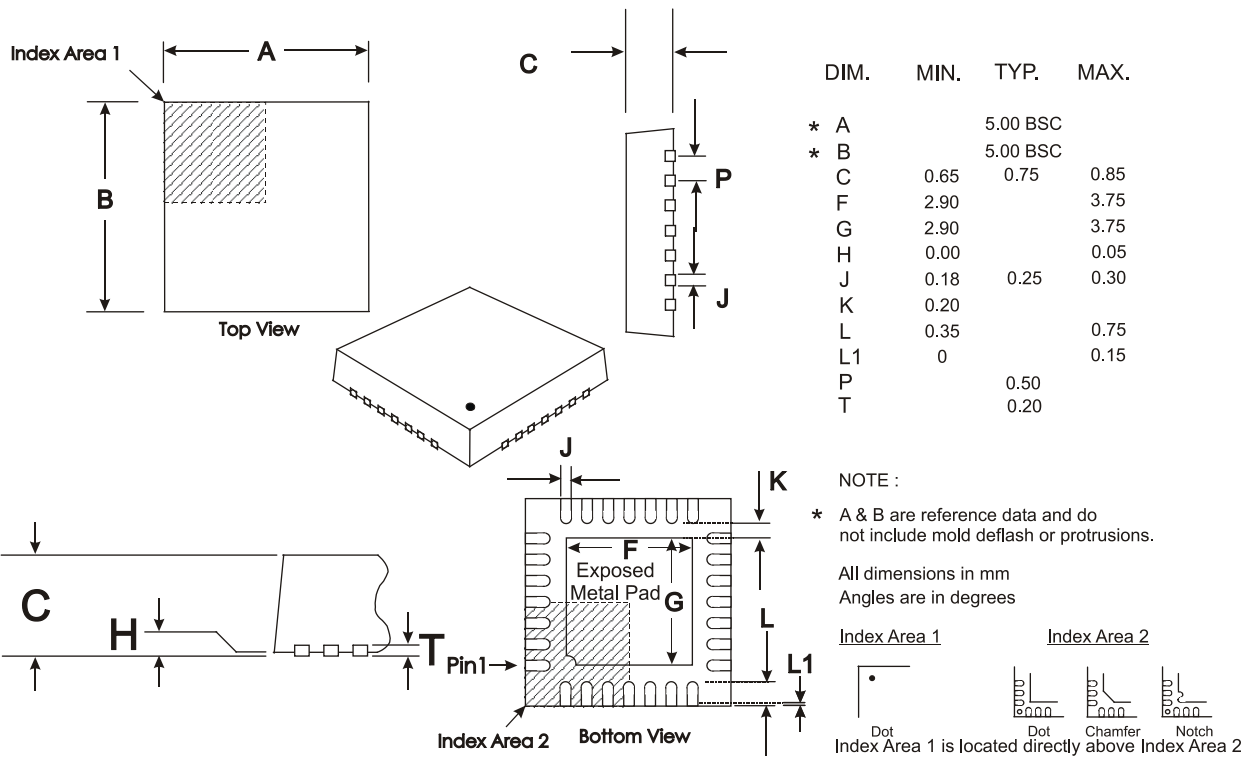

Depending on the method of lead termination at the edge of the package, pull back (L1) may be present. L minus L1 to be equal to, or greater than 0.3mm

The underside of the package has an exposed metal pad which should ideally be soldered to the pcb to enhance the thermal conductivity and mechanical strength of the package fixing. Where advised, an electrical connection to this metal pad may also be required

Figure 17 QT8 Mechanical Outline of 28-pin WQFN (QT8)

9.1 Ordering

Order as Part No. CMX901 QT8

Handling precautions: This product includes input protection, however, precautions should be taken to prevent device damage from electro-static discharge. CML does not assume any responsibility for the use of any circuitry described. No IPR or circuit patent licences are implied. CML reserves the right at any time without notice to change the said circuitry and this product specification. CML has a policy of testing every product shipped using calibrated test equipment to ensure compliance with this product specification. Specific testing of all circuit parameters is not necessarily performed.

	United Kingdom	p: +44 (0) 1621 875500	e: sales@cmlmicro.com techsupport@cmlmicro.com
	Singapore	p: +65 62888129	e: sg.sales@cmlmicro.com sg.techsupport@cmlmicro.com
	United States	p: +1 336 744 5050 800 638 5577	e: us.sales@cmlmicro.com us.techsupport@cmlmicro.com

www.cmlmicro.com