

Product Specification

NHD-2.8-25664UCB2

Graphic OLED Display Module

NHD-	Newhaven Display
2.8-	2.8" Diagonal Size
25664-	256 x 64 Pixel Resolution
UC-	Model
B-	Emitting Color: Blue
2-	3V Power Supply

Table of Contents

Document Revision History.....	2
Mechanical Drawing	3
Pin Description	4
Wiring Diagrams	5
On-Board Jumper Options	6
Electrical Characteristics	7
Optical Characteristics	7
Controller Information.....	8
MPU Interface	8
Example Initialization Sequence.....	9
Quality Information	10

Additional Resources

- **Support Forum:** <https://support.newhavendisplay.com/hc/en-us/community/topics>
- **GitHub:** <https://github.com/newhavendisplay>
- **Example Code:** <https://support.newhavendisplay.com/hc/en-us/categories/4409527834135-Example-Code/>
- **Knowledge Center:** https://www.newhavendisplay.com/knowledge_center.html
- **Quality Center:** https://www.newhavendisplay.com/quality_center.html
- **Precautions for using LCDs/LCMs:** <https://www.newhavendisplay.com/specs/precautions.pdf>
- **Warranty / Terms & Conditions:** <https://www.newhavendisplay.com/terms.html>



Document Revision History

Revision	Date	Description	Changed By
0	05/01/2011	Initial Product Release	-
1	02/21/2013	Electrical characteristics and mechanical drawing updated	JN
2	03/16/2020	Electrical Characteristics & Segment Layout Updated	SB
3	10/23/2020	Updated Supply Voltage Range: (3V/3.3V/3.5V) to (2.8V/3V/3.3V)	AS
4	07/21/2022	PCB redesign offering multiple driving methods. Electrical characteristics updated. Mechanical drawing updated.	CJ

Mechanical Drawing

SYMBOL	REVISION	DATE

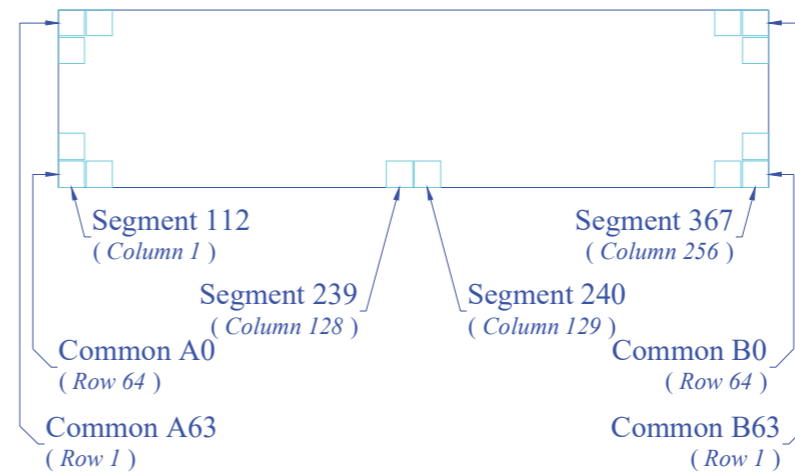
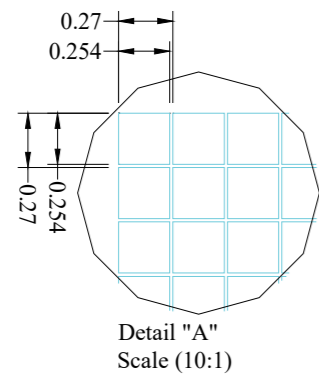
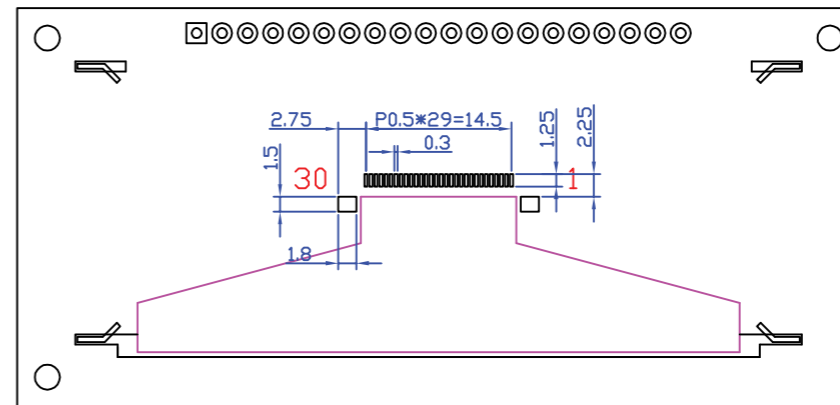
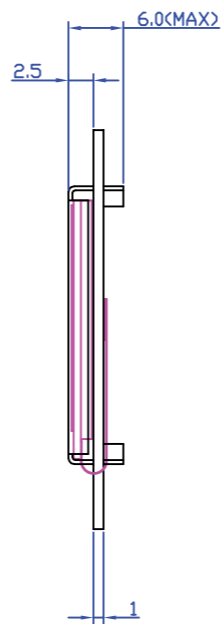
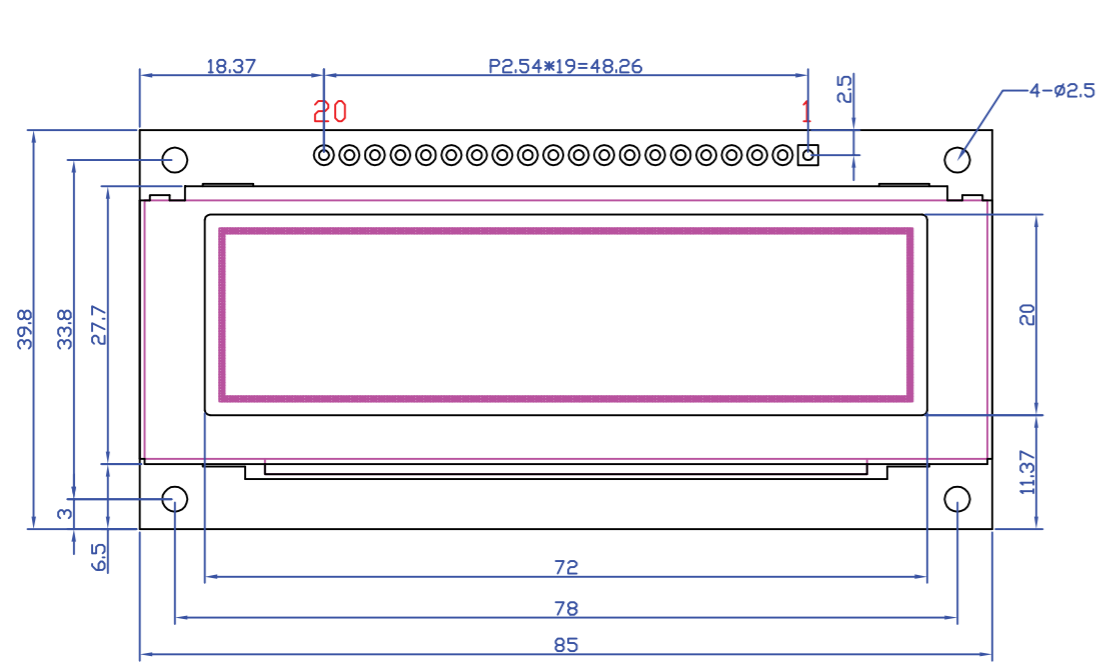

Pin No.	Symbol
1	VSS
2	VDD
3	NC or BC_VDD
4	D/C
5	R/W or /WR
6	E or /RD
7-14	DB0 – DB7
15	NC or VCC
16	/RES
17	/CS
18	NC or G_VDD
19	BS1
20	BS0

- Product Description: 2.8" Blue Graphic OLED
- OLED Driver IC: SSD1322
 - OLED Interface: 3-/4-wire Serial, 8-bit 6800/8080 Parallel
 - OLED Power Requirement: 3.3V/310mA
 - Mating Connector: 20 pin, 2.54mm pitch pins

Standard Tolerance: (Unless otherwise specified) Linear: ±0.3mm		
	Drawing/Part Number: NHD-2.8-25664UCB2	Revision: -
Unless otherwise specified: • Dimensions are in Millimeters • Third Angle Projection	Drawn By: C. Johnson	Approved By: C. Johnson
	Drawn Date: 07/21/2022	Approved Date: 07/21/2022
Do Not Scale Drawing		Size: A3 Scale: NS
Sheet 1 of 1		
This drawing is solely the property of Newhaven Display International, Inc. The information it contains is not to be disclosed, reproduced or copied in whole or part without written approval from Newhaven Display.		

Pin Description

Parallel Interface:

Pin No.	Symbol	External Connection	Function Description
1	V _{SS}	Power Supply	Ground
2	V _{DD}	Power Supply	Supply Voltage for OLED and logic.
3	NC or BC_VDD	-	Default: No Connect Supply Voltage for Boost Converter: See Jumper Option #1
4	D/C	MPU	Register select signal. D/C=0: Command, D/C=1: Data
5	R/W or /WR	MPU	6800-interface: Read/Write select signal, R/W=1: Read, R/W=0: Write 8080-interface: Active LOW Write signal.
6	E or /RD	MPU	6800-interface: Operation enable signal. Falling edge triggered. 8080-interface: Active LOW Read signal.
7-14	DB0 – DB7	MPU	8-bit Bi-directional data bus lines.
15	NC or VCC	-	Default: No Connect Supply Voltage for OLED Panel: See Jumper Option #2
16	/RES	MPU	Active LOW Reset signal.
17	/CS	MPU	Active LOW Chip Select signal.
18	NC or G_VDD	-	Default: No Connect Supply Voltage for Internal Regulator: See Jumper Option #3
19	BS1	MPU	MPU Interface Select signal.
20	BS0	MPU	MPU Interface Select signal.

Serial Interface:

Pin No.	Symbol	External Connection	Function Description
1	V _{SS}	Power Supply	Ground
2	V _{DD}	Power Supply	Supply Voltage for OLED and logic.
3	NC or BC_VDD	-	Default: No Connect Supply Voltage for Boost Converter: See Jumper Option #1
4	D/C	MPU	Register select signal. D/C=0: Command, D/C=1: Data Tie LOW for 3-wire Serial Interface.
5-6	VSS	Power Supply	Ground
7	SCLK	MPU	Serial Clock signal.
8	SDIN	MPU	Serial Data Input signal.
9	NC	-	No Connect
10-14	VSS	Power Supply	Ground
15	NC or VCC	-	Default: No Connect Supply Voltage for OLED Panel: See Jumper Option #2
16	/RES	MPU	Active LOW Reset signal.
17	/CS	MPU	Active LOW Chip Select signal.
18	NC or G_VDD	-	Default: No Connect Supply Voltage for Internal Regulator: See Jumper Option #3
19	BS1	MPU	MPU Interface Select signal.
20	BS0	MPU	MPU Interface Select signal.

MPU Interface Pin Selections

Pin Name	6800 Parallel 8-bit interface	8080 Parallel 8-bit interface	3-wire Serial Interface	4-wire Serial Interface
BS1	1	1	0	0
BS0	1	0	1	0

MPU Interface Pin Assignment Summary

Bus Interface	Data/Command Interface								Control Signals				
	D7	D6	D5	D4	D3	D2	D1	D0	E	R/W	/CS	D/C	/RES
8-bit 6800	D[7:0]								E	R/W	/CS	D/C	/RES
8-bit 8080	D[7:0]								/RD	/WR	/CS	D/C	/RES
3-wire SPI	Tie LOW			NC		SDIN	SCLK	Tie LOW		/CS	Tie LOW	/RES	
4-wire SPI	Tie LOW			NC		SDIN	SCLK	Tie LOW		/CS	D/C	/RES	

Wiring Diagrams

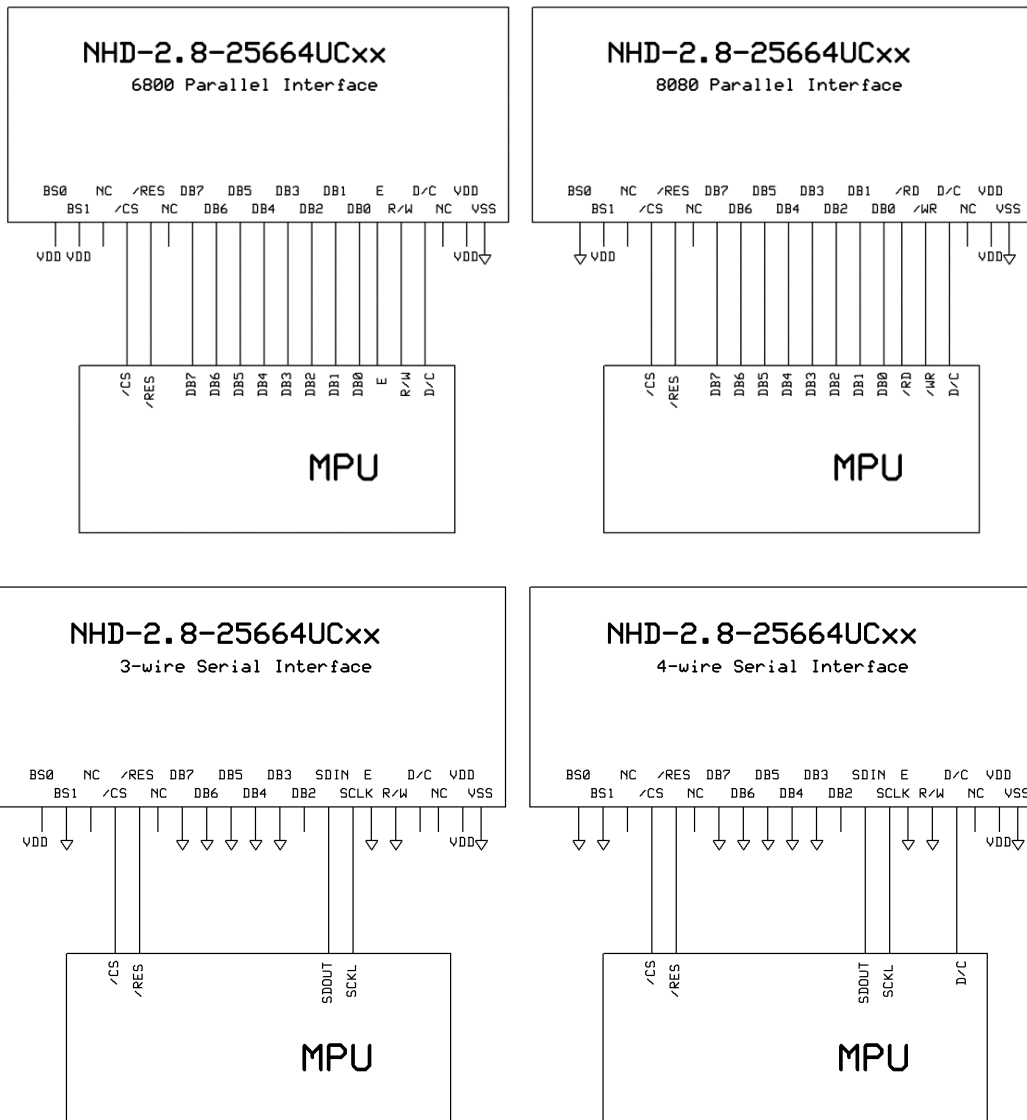

On-Board Jumper Options

Default Jumper Setting

R14	R15	R18	R1	Description
Close	Open	Open	Open	(default) OLED Logic Circuit + Boost converter + OLED panel are powered from VDD (pin #2). This allows the full module to be powered by a single low-voltage supply.

Jumper Option #1 - Independent Supply Voltage for Boost Converter (BC_VDD)

R14	R15	R18	R1	Description
Open	Close	Open	Open	Boost converter + OLED panel are powered from BC_VDD (pin #3). OLED Logic Circuit is powered from VDD (pin #2). This allows for increased efficiency through the boost converter, by allowing a supply voltage up to +12V at its input, BC_VDD (pin #3).

Jumper Option #2 – External Supply Voltage for OLED Panel (VCC)

R14	R15	R18	R1	Description
Open	Open	Close	Open	OLED panel is powered from VCC (pin #15) – boost converter is not used. OLED Logic Circuit is powered from VDD (pin #2). This allows for maximum module efficiency, and drastically reduced total current consumption.

Jumper Option #3 – External Supply Voltage for Internal Regulator (G_VDD)

R14	R15	R18	R1	Description
See Description			Close	OLED Internal Regulator + Logic Circuit are powered from G_VDD (pin #18) – boost converter is powered from VDD (pin #2). Disabling the internal regulator reduces power consumption. Booster circuit must be driven by alternative method.

Default Jumper Setting

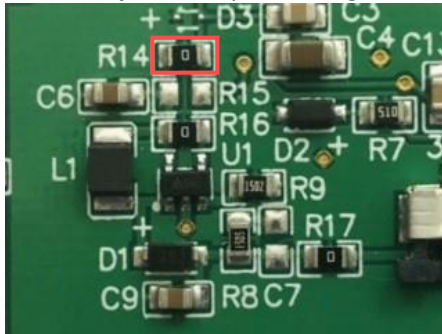

Jumper Option #1 (BC_VDD)

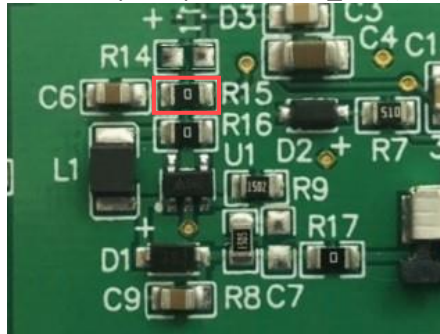

Jumper Option #2 (VCC)



Jumper Option #3 (G_VDD)



For detailed electrical information on each jumper option, please see the Electrical Characteristics table below.

Electrical Characteristics

Item	Symbol	Condition	Min.	Typ.	Max.	Unit
Operating Temperature Range	T _{op}	Absolute Max	-40	-	+85	°C
Storage Temperature Range	T _{st}	Absolute Max	-40	-	+90	°C
Default Jumper Setting						
Supply Voltage for Module	VDD	-	2.8	3.3	3.5	V
Supply Current for Module	IDD	VDD=3.3V, 100% ON	-	310	340	mA
Jumper Option #1						
Supply Voltage for Module	VDD	-	2.8	3.3	3.5	V
Supply Current for Module	IDD	V _{DD} =3.3V	-	170	200	μA
Supply Voltage for Boost Converter	BC_VDD	-	2.8	-	12	V
Supply Current for Boost Converter	BC_IDD	BC_VDD=5.0V, 100% ON	-	170	200	mA
		BC_VDD=12.0V, 100% ON	-	70	80	mA
Jumper Option #2						
Supply Voltage for Module	VDD	-	2.8	3.3	3.5	V
Supply Current for Module	IDD	V _{DD} =3.3V	-	170	200	μA
Supply Voltage for OLED Panel	VCC	-	11.5	12	12.5	V
Supply Current for OLED Panel	ICC	VCC=12V, 100% ON	-	45	55	mA
Jumper Option #3						
Supply Voltage for Logic	G_VDD	-	2.4	2.5	2.6	V
Supply Current for Module	G_IDD	VDD=3.3V	-	100	120	μA
Sleep Mode Current	IDD _{SLEEP}	-	-	25	120	μA
"H" Level input	V _{ih}	-	0.8*VDD	-	VDD	V
"L" Level input	V _{il}	-	VSS	-	0.2*VDD	V
"H" Level output	V _{oh}	-	0.9*VDD	-	VDD	V
"L" Level output	V _{ol}	-	VSS	-	0.1*VDD	V

Note: The electrical characteristics shown above for Jumper Option #1 and Jumper Option #2 apply only when the on-board jumpers are configured accordingly. By default, only Default Jumper Setting supply voltage and current (in bold) need to be considered. For details, see On-Board Jumper Options section on previous page.

Optical Characteristics

Item	Symbol	Condition	Min.	Typ.	Max.	Unit
Optimal Viewing Angles	Top	φY+	-	80	-	°
	Bottom	φY-	-	80	-	°
	Left	θX-	-	80	-	°
	Right	θX+	-	80	-	°
Contrast Ratio	CR	-	2000:1	-	-	-
Response Time	Rise	T _R	-	10	-	us
	Fall	T _F	-	10	-	us
Brightness	L _V	T _{OP} = 25°C	60	80	-	cd/m ²
Lifetime	-	50% Checkerboard	10,000	20,000	-	Hrs.

Note: Lifetime at typical temperature is based on accelerated high-temperature operation. Lifetime is tested at average 50% pixels on and is rated as Hours until **Half-Brightness**. The Display OFF command can be used to extend the lifetime of the display. Luminance of active pixels will degrade faster than inactive pixels. Residual (burn-in) images may occur. To avoid this, every pixel should be illuminated uniformly.

Controller Information

Built in SSD1322 Controller

For detailed information please download datasheet: <https://support.newhavendisplay.com/hc/en-us/articles/4414477846679-SSD1322>

MPU Interface

6800-MPU Parallel Interface

The parallel interface consists of 8 bi-directional data pins, R/W, D/C, E, and /CS.

A LOW on R/W indicates write operation, and HIGH on R/W indicates read operation.

A LOW on D/C indicates “Command” read or write, and HIGH on D/C indicates “Data” read or write.

The E input serves as data latch signal, while /CS is LOW. Data is latched at the falling edge of E signal.

Function	E	R/W	/CS	D/C
Write Command	↓	0	0	0
Read Status	↓	1	0	0
Write Data	↓	0	0	1
Read Data	↓	1	0	1

8080-MPU Parallel Interface

The parallel interface consists of 8 bi-directional data pins, /RD, /WR, D/C, and /CS.

A LOW on D/C indicates “Command” read or write, and HIGH on D/C indicates “Data” read or write.

A rising edge of /RS input serves as a data read latch signal while /CS is LOW.

A rising edge of /WR input serves as a data/command write latch signal while /CS is LOW.

Function	/RD	/WR	/CS	D/C
Write Command	1	↑	0	0
Read Status	↑	1	0	0
Write Data	1	↑	0	1
Read Data	↑	1	0	1

Alternatively, /RD and /WR can be kept stable while /CS serves as the data/command latch signal.

Function	/RD	/WR	/CS	D/C
Write Command	1	0	↑	0
Read Status	0	1	↑	0
Write Data	1	0	↑	1
Read Data	0	1	↑	1

Serial Interface (4-wire)

The 4-wire serial interface consists of serial clock SCLK, serial data SDIN, D/C, and /CS.

D0 acts as SCLK and D1 acts as SDIN. D2 should be left open. D3~D7, E, and R/W should be connected to GND.

Function	/RD	/WR	/CS	D/C	D0
Write Command	Tie LOW	Tie LOW	0	0	↑
Write Data	Tie LOW	Tie LOW	0	1	↑

SDIN is shifted into an 8-bit shift register on every rising edge of SCLK in the order of D7, D6,...D0.

D/C is sampled on every eighth clock and the data byte in the shift register is written to the GDRAM or command register in the same clock. *Note: Read is not available in serial mode*

Serial Interface (3-wire)

The 3-wire serial interface consists of serial clock SCLK, serial data SDIN, and /CS.

D0 acts as SCLK and D1 acts as SDIN. D2 should be left open. D3~D7, E, R/W, and D/C should be connected to GND.

Function	/RD	/WR	/CS	D/C	D0
Write Command	Tie LOW	Tie LOW	0	Tie LOW	↑
Write Data	Tie LOW	Tie LOW	0	Tie LOW	↑

SDIN is shifted into an 9-bit shift register on every rising edge of SCLK in the order of D/C, D7, D6,...D0.

D/C (first bit of the sequential data) will determine if the following data byte is written to the Display Data RAM (D/C = 1) or the command register (D/C = 0). *Note: Read is not available in serial mode*

Example Initialization Sequence

```

Set_Command_Lock(0x12);           // Unlock Basic Commands (0x12/0x16)
Set_Display_On_Off(0x00);        // Display Off (0x00/0x01)
Set_Column_Address(0x1C,0x5B);
Set_Row_Address(0x00,0x3F);
Set_Display_Clock(0x91);         // Set Clock as 80 Frames/Sec
Set_Multiplex_Ratio(0x3F);       // 1/64 Duty (0x0F~0x3F)
Set_Display_Offset(0x00);        // Shift Mapping RAM Counter (0x00~0x3F)
Set_Start_Line(0x00);           // Set Mapping RAM Display Start Line (0x00~0x7F)
Set_Remap_Format(0x14);         // Set Horizontal Address Increment
                                // Column Address 0 Mapped to SEG0
                                // Disable Nibble Remap
                                // Scan from COM[N-1] to COM0
                                // Disable COM Split Odd Even
                                // Enable Dual COM Line Mode
Set_GPIO(0x00);                 // Disable GPIO Pins Input
Set_Function_Selection(0x01);    // Enable Internal VDD Regulator
Set_Display_Enhancement_A(0xA0,0xFD); // Enable External VSL
Set_Contrast_Current(0x9F);      // Set Segment Output Current
Set_Master_Current(0x0F);        // Set Scale Factor of Segment Output Current Control
//Set_Gray_Scale_Table();        // Set Pulse Width for Gray Scale Table
Set_Linear_Gray_Scale_Table();   //set default linear gray scale table
Set_Phase_Length(0xE2);          // Set Phase 1 as 5 Clocks & Phase 2 as 14 Clocks
Set_Display_Enhancement_B(0x20); // Enhance Driving Scheme Capability (0x00/0x20)
Set_Precharge_Voltage(0x1F);     // Set Pre-Charge Voltage Level as 0.60*VCC
Set_Precharge_Period(0x08);      // Set Second Pre-Charge Period as 8 Clocks
Set_VCOMH(0x07);                // Set Common Pins Deselect Voltage Level as 0.86*VCC
Set_Display_Mode(0x02);          // Normal Display Mode (0x00/0x01/0x02/0x03)
Set_Partial_Display(0x01,0x00,0x00); // Disable Partial Display
Set_Display_On_Off(0x01);

```

Quality Information

Test Item	Content of Test	Test Condition	Note
High Temperature storage	Test the endurance of the display at high storage temperature.	+90°C, 240hrs	2
Low Temperature storage	Test the endurance of the display at low storage temperature.	-40°C, 240hrs	1,2
High Temperature Operation	Test the endurance of the display by applying electric stress (voltage & current) at high temperature.	+85°C, 240hrs	2
Low Temperature Operation	Test the endurance of the display by applying electric stress (voltage & current) at low temperature.	-40°C, 240hrs	1,2
High Temperature / Humidity Operation	Test the endurance of the display by applying electric stress (voltage & current) at high temperature with high humidity.	+60°C, 90% RH, 240hrs	1,2
Thermal Shock resistance	Test the endurance of the display by applying electric stress (voltage & current) during a cycle of low and high temperatures.	-40°C,30min -> 25°C,5min -> 85°C,30min = 1 cycle 100 cycles	
Vibration test	Test the endurance of the display by applying vibration to simulate transportation and use.	10-22Hz, 1.5mm amplitude. 22-500Hz, 1.5G 30min in each of 3 directions X, Y, Z	3
Atmospheric Pressure test	Test the endurance of the display by applying atmospheric pressure to simulate transportation by air.	115mbar, 40hrs	3
Static electricity test	Test the endurance of the display by applying electric static discharge.	VS=800V, RS=1.5kΩ, CS=100pF One time	

Note 1: No condensation to be observed.

Note 2: Conducted after 2 hours of storage at 25°C, 0%RH.

Note 3: Test performed on product itself, not inside a container.

Evaluation Criteria:

- 1: Display is fully functional during operational tests and after all tests, at room temperature.
- 2: No observable defects.
- 3: Luminance >50% of initial value.
- 4: Current consumption within 50% of initial value