

Introduction

The increased bandwidth and faster operation of the newest microprocessor cores brought along the need for higher current capability converters. Targeting Pentium® 4 type processors (and others in the same range), the HIP6301-based 3-phase buck converter presented in this application note exemplifies a typical practical implementation of a core regulator for output currents up to 55A. [1,2]

Quick Start Evaluation

Important

The four-pin connector (J7; see schematic on page 5) on the evaluation board is meant to couple only with the matching 12V connector from an **ATX12V supply** only. Some newer models of ATX supplies have a similar connector which carries GND, 3.3V, 5V, and 12V. An attempt to mate such a connector to the on-board receptacle can result in a potentially dangerous situation, and it will certainly prevent the power supply from operating. If an **ATX12V** power supply is unavailable, use only the 20-pin connector from the available ATX supply to power up the board.

Circuit Setup

The HIP6301EVAL2 is built for evaluation using ordinary laboratory equipment, specialized tools, or a combination of the two. Best (and possibly easiest if the tools are available) way to evaluate the circuit is by using an ATX supply and an Intel PGA423 EMT Tool.

%% Set Up JP1, JP2, and JP3

Consult the circuit schematic and data sheet and set the JP1 VID jumper combination on the HIP6503EVAL1 according to the output voltage you wish to evaluate the board at. If using an EMT Tool, it is advised you set the similar jumpers present on the test tool to the same code, or de-populate them altogether.

JP2 and JP3 allow remote sensing of the output voltage at TP8 and, alternately, at TP10, TP11. By placing the shunts in the 'PLANE' position (see top silk screen on page 8), the voltage present at the test points will reflect the output voltage on the board, physically close to the center of the processor socket's cavity. The 'PIN' position reflects the processor-die (load) voltage fed back through the voltage sensing pins present on the test tool (if equipped) and the processor package.

%% Connect the Input Power Supply

Connect the main ATX output connector to J6. If an ATX12V supply is used, connect the dedicated 12V 4-pin connector to J7. Regulation of the ATX supplies is generally dependent on the presence of a load on the main 5V output - for best results, have a 5Ω/25W-50W power resistor connected to

the 5V output of the ATX supply (take necessary precautions, as the resistor may get very hot).

If regular bench supplies are used, connect a 12V/10A and a 5V/1A supply to J1, J2, respectively; connect both grounds to J3.

%% Connect the Output Load

Connect an electronic or resistive load to the evaluation board's output (J4 and J5), or use an Intel PGA423 EMT Tool (J8).

Operation

%% Apply Power to the Board

Plug the ATX supply into the mains. If the supply has an AC switch, turn it on. If using standard bench supplies, turn them on, preferably the 12V supply first, followed by the 5V supply. If the 5V is applied first, the soft-start will likely end before application of the 12V, resulting in an initial over-current event, followed by a normal output voltage ramp-up. Occasionally, application of voltages in the improper sequence may result in an initial over-voltage event, latching the evaluation board off. In such instance, cycle the bias power to the controller IC (5V) to reset the latch.

%% Examine Start-Up Waveforms

Start-up is immediate following application of power. After a quick red flash, the CR1 LED indicator should turn green, indicating a PGOOD high (good output voltage). Using an oscilloscope or other laboratory equipment, you may study the ramp-up and/or regulation of the controlled output voltage under various loading/transient conditions.

HIP6301EVAL2 Reference Design

General

The evaluation design is implemented on 2-ounce, 4-layer, printed circuit board (see last pages of this application note for layout plots). Wherever needed to reduce layout parasitics, via-in-pad (VIP) layout techniques were employed. The entire circuit fits inside a 6in² rectangle on the top side of the board. For better space utilization and enhanced thermal performance, the upper switch MOSFETs on each channel are vertically mounted.

For ease of evaluation, the circuit can be powered up from either bench supplies, regular ATX supplies, or special ATX12V computer supplies. Similarly, the output can be exercised using either an Intel EMT tool, resistive loads, or electronically controlled active loads. For best performance during evaluation, when applicable, insure the ATX 5V output is loaded with a minimum of 1A current draw - this will keep the 12V output regulation within specified limits.

Design Envelope

The HIP6301EVAL2 was designed to meet the performance envelope outlined in Table 1. As such, the design covers the full range of foreseeable upcoming Pentium 4 processors.

TABLE 1. HIP6301EVAL2 OUTPUT PARAMETERS

NO-LOAD OUTPUT VOLTAGE	FULL-LOAD OUTPUT VOLTAGE	MAX. OUTPUT CURRENT	MAX. OUTPUT CURRENT di/dt
1.685V	1.600V	54A	400A/ μ s

HIP6301EVAL2 Performance

Output Soft-Start

The HIP6301 controller undergoes a soft-start cycle each time power-on reset (POR) transitions from high to low (input bias application), or when the chip is enabled for operation (FS/DIS pin released from a pull-down). Figure 1 details an output soft-start cycle. Power is applied to the circuit prior to time T0, then the circuit is disabled by shorting the FS/DIS pin to ground. At time T0, the FS/DIS pin is released from the short-circuit to ground, and shortly thereafter, the output voltage starts to ramp up. The low-frequency ripple visible in the current drawn from the input supply is a result of the digital soft-start building the output voltage in small increments. Similarly, this stepping method is reflected into the output voltage and the COMP pin waveforms.

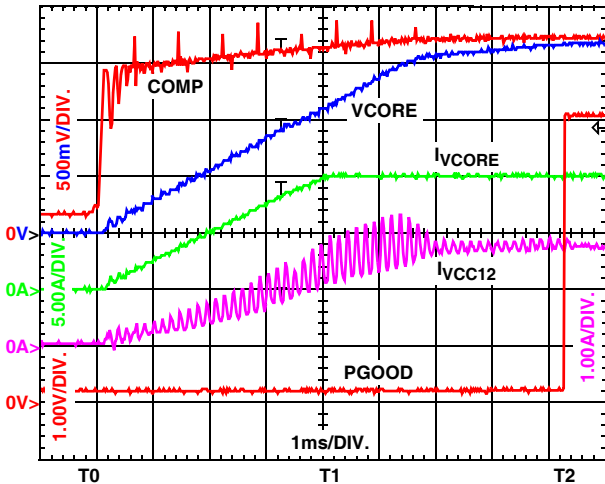

FIGURE 1. HIP6301EVAL2 START-UP SEQUENCE UNDER APPLIED CONSTANT-CURRENT OUTPUT LOAD

At time T1, the output voltage is sufficiently high to allow the electronic load to draw the full 10A. At time T2 the soft-start cycle ends and the PGOOD pin is enabled to report the result of the output monitoring function.

Transient Response

Paramount to the performance of a switching regulator dedicated to supplying power to a microprocessor core, the transient performance of the evaluation board has been thoroughly documented in the following figures.

Figure 2 details the converter's response to a low-frequency 55A transient. As it is evident from the scope capture, the design implements output voltage droop as a means to meet the dynamic transient requirements while employing a minimum amount of output capacitance. The nominal no-load output voltage is also offset low by design. Strict power requirements limit the maximum output voltage to the VID-set voltage level (1.70V in this case).

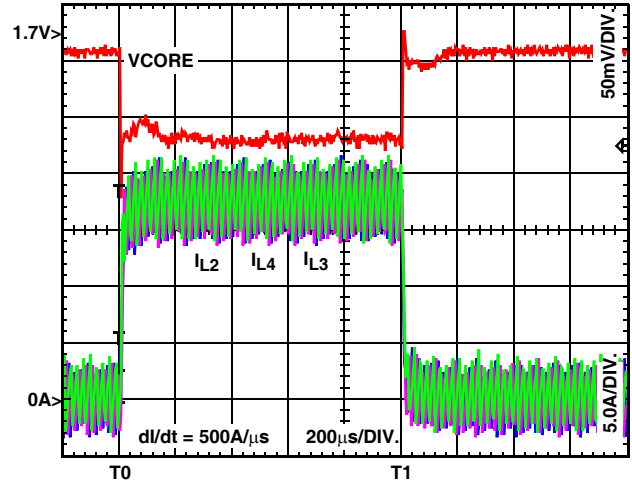

FIGURE 2. HIP6301EVAL2 OUTPUT VOLTAGE AND PHASE CURRENTS TRANSIENT RESPONSE - LOW FREQUENCY TRANSIENT (500Hz)

Figure 3 depicts a similar scenario, with the difference residing in the frequency of the transient applied (33kHz). The exercise is performed to detail the swift response of the converter and the tight output voltage regulation across a typical range of output loading. The short-duration spikes exceeding the 1.70V maximum level would be further reduced in a practical implementation: the processor current transient has a softer turn on/off characteristic than the EMT test tool.

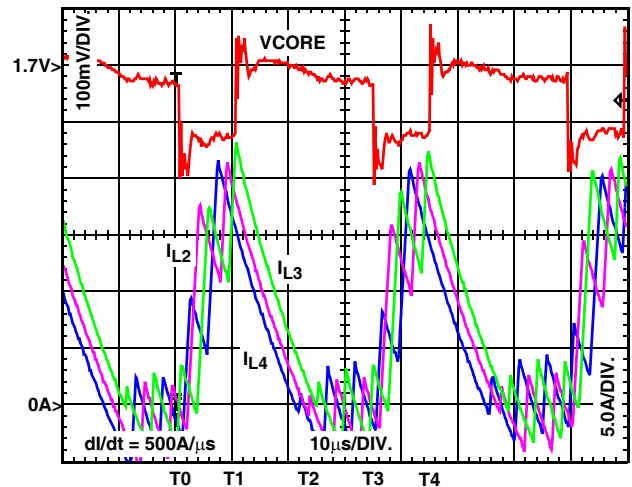

FIGURE 3. HIP6301EVAL2 OUTPUT VOLTAGE AND PHASE CURRENTS TRANSIENT RESPONSE - HIGH FREQUENCY TRANSIENT (33kHz)

Phase-to-Phase Current Sharing

Figures 4 and 5 take the transient response to yet another level of detail, in order to showcase the phase-to-phase current matching. As it can be easily observed in either figure, the phase-to-phase steady-state current matching of the evaluation board is typically 1A or less. During transient edge dynamic response, the phase-to-phase current mismatch is evident, result of the specific timing relationships that govern the HIP6301's operation. The matching appearance of the current waveforms flowing through each of the converter's phases suggests equally matched channel-to-channel power dissipation and thermal performance.

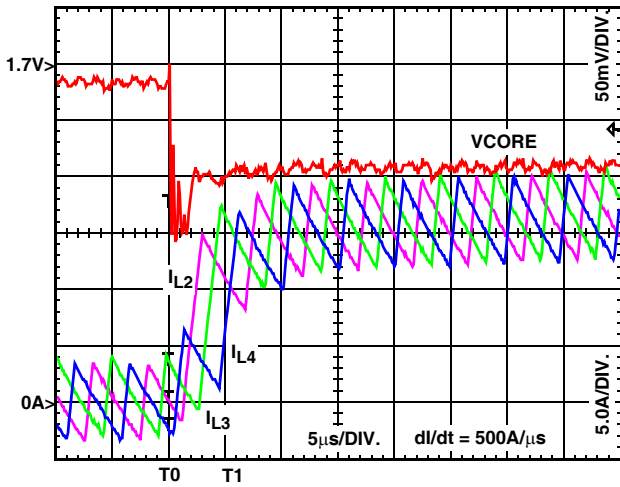

FIGURE 4. HIP6301EVAL2 OUTPUT VOLTAGE AND PHASE CURRENTS TRANSIENT RESPONSE - LEADING EDGE (0A - 54A)

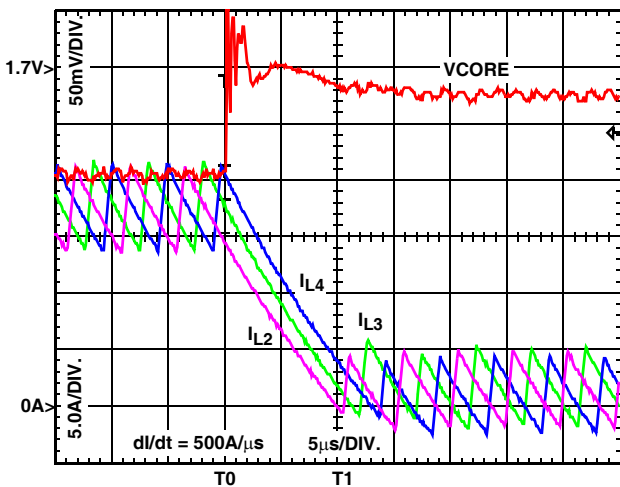

FIGURE 5. HIP6301EVAL2 OUTPUT VOLTAGE AND PHASE CURRENTS TRANSIENT RESPONSE - FALLING EDGE (54A - 0A)

An additional important aspect of the transient response operation is the response speed of the converter. As it can be seen, it takes around a microsecond for the duty cycle of one phase to exhibit a visible response to the transient

excitation. In both figures (4 and 5), the dynamic transient excitation occurs at time T0. As it may be noticed in Figure 4, the first-order response of the converter (representing the bulk of the current step) takes place in a time interval of only 5µs to 6µs. The converter's response to the tail end of the transient (Figure 5) is equally fast; however, in this case, the current ramp-down of the output inductors is, mainly, only a function of the inductor value and the output voltage.

One important parameter contributing to an exemplary phase-to-phase current matching is layout. As it may be observed in the layout plots included at the end of the application note, all channels have an identical, tight layout, with a ground plane exhibiting minimal voids between the controller and the individual channel blocks.

Circuit Efficiency

Figure 6 shows the laboratory-measured evaluation board efficiency. Measurements were performed at room temperature, with approximately 100 linear feet per minute (100 lfm) air flow.

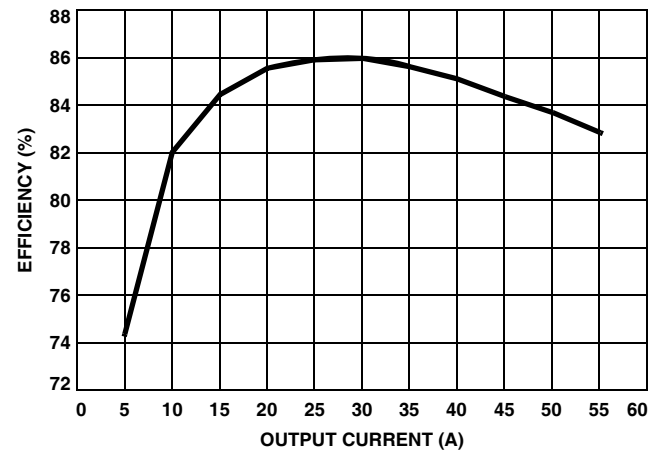

FIGURE 6. HIP6301EVAL2 EFFICIENCY (ROOM TEMPERATURE, 100LFM AIR FLOW)

Output Short-Circuit Protection

Figure 7 captures the circuit's response to an output overloading caused by a short-circuit. At time T0, a short-circuit is applied to the output of the converter. Responding to the output overload, the circuit ramps up the output current. At time T1, the current has reached a level high enough to trip the over-current protection. The converter shuts down and the output voltage collapses under the current draw of the output short-circuit.

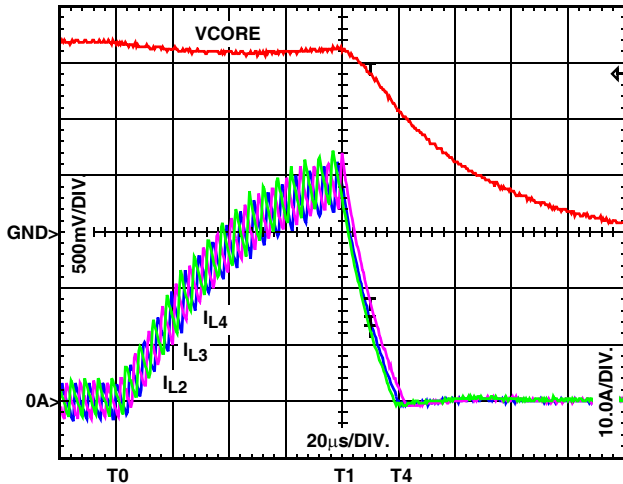

FIGURE 7. HIP6301EVAL2 SHORT-CIRCUIT PROTECTION SHUTDOWN

Figure 8 details the hiccup mode the converter resorts to in case of a persisting output short-circuit condition. At time T0 the first short-circuit condition is encountered and the converter shuts down. After a wait period of about 2200 switching cycles (about 11ms), the converter attempts to re-start, soft-starting the output at time T1. As a result, the output voltage increases to the point where the current drawn by the short-circuit trips, again, the over-current protection. The cycle repeats ad libitum for as long as the short-circuit is applied to the converter's output.

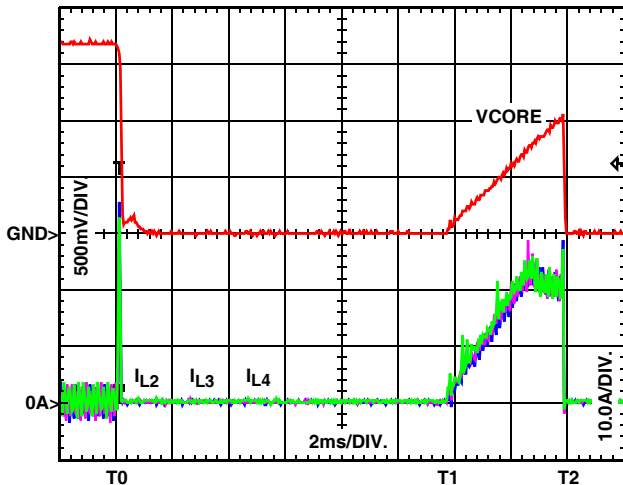

FIGURE 8. HIP6301EVAL2 SHORT-CIRCUIT PROTECTION HICCUP MODE

HIP6301EVAL2 Modifications

Output Voltage Transient Response

The evaluation board has some additional capacitor footprints (C81-90) made available for various experiments. These footprints can be used to add output capacitance,

make substitutions, or even replace the provided on-board capacitors altogether. Similarly, many of the ceramic capacitors can be replaced, varying the quantity and the mix, thus shaping the high-frequency dynamic response to fit certain required envelope.

Tailoring Circuit Performance

As delivered, the evaluation board is optimized for the maximum current of 55A. In this configuration, the circuit represents a finite design point, exhibiting a characteristic blend of functionality, performance, and cost. Various trade-offs can be made to enhance the circuit with emphasis on one parameter, most times with negative results on others.

For output currents below 55A, typical modifications relate to cost reductions in the circuit's bill of materials. Popular changes include using slightly higher $r_{DS(ON)}$ MOSFETs, downgrading (using higher ESR types) the output capacitors, reducing the number/mix of output high-frequency decoupling, etc. Significantly lower current applications may prompt more drastic circuit changes, such as disablement of one of the three phases. For such applications (typically requiring less than 36A), we recommend considering evaluating dedicated 2-phase circuits.

Conclusion

The HIP6301EVAL2 evaluation board is a flexible tool designed to showcase the operation of a 3-phase synchronous buck switching converter built using Intersil HIP6301 Multiphase Buck PWM Controller and the HIP6601A Synchronous Buck MOSFET drivers. The controller-drivers combination has the necessary application flexibility to address custom-tailored solutions supporting existing, as well as near-future microprocessor offerings.

References

For Intersil documents available on the internet, see web site www.intersil.com/

Intersil Technical Support 1 (888) INTERSIL

- [1] *HIP6301 Data Sheet*, Intersil Corporation, Power Management Products Division, FN4765. (www.intersil.com/)
- [2] *HIP6601A Data Sheet*, Intersil Corporation, Power Management Products Division, FN4884.

HIP6301EVAL2 Schematic

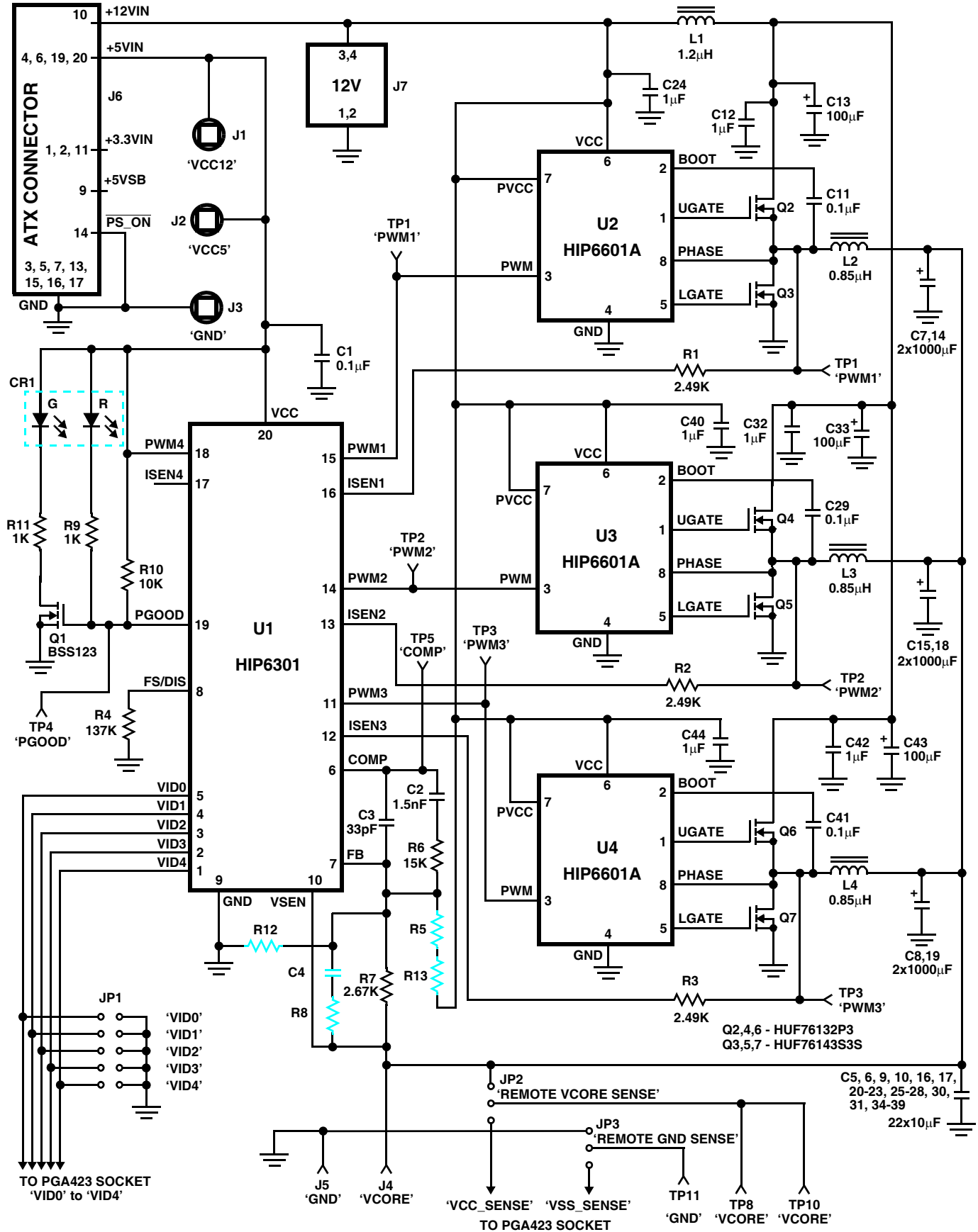

HIP6301EVAL2 Schematic (continued)

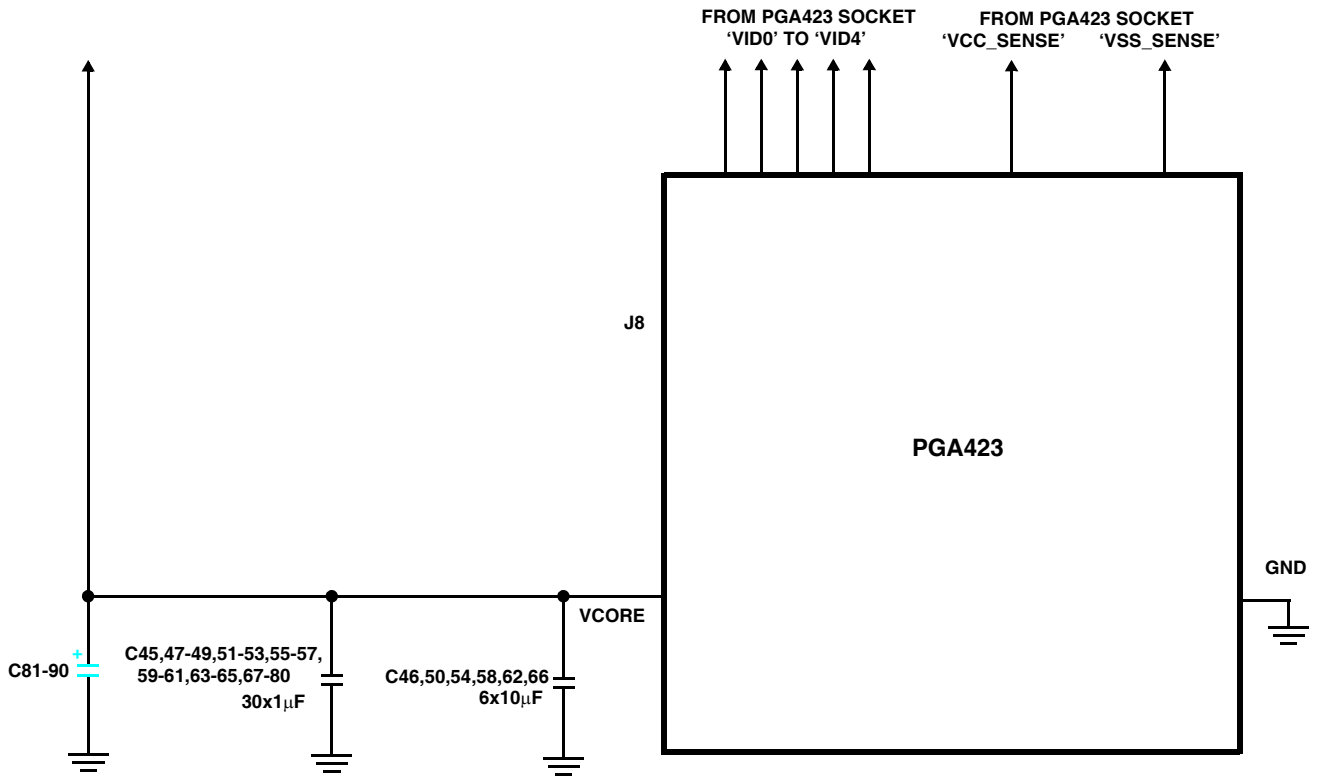

Application Note 9906

Bill of Materials for HIP6301EVAL2

REFERENCE DESIGNATOR	PART NUMBER	DESCRIPTION	CASE / FOOTPRINT	MANUF. OR VENDOR	QTY
C1,11,29,41	0.1 μ F Ceramic	Ceramic Capacitor, X7R, 25V, 0.1 μ F	0805	Any	4
C2	1.5nF Ceramic	Ceramic Capacitor, X7R, 25V, 1.5nF	0805	Any	1
C3	33pF Ceramic	Ceramic Capacitor, X7R, 50V, 33pF	0805	Any	1
C5,6,9,10,16,17, 20-23,25-28,30,31, 34-39,46,50,54, 58, 62,66	C3216X5R0J106M	Ceramic Capacitor, X5R, 6.3V, 10 μ F	1206	TDK	28
C7,8,14,15,18,19	2SP1000M	OSCON Capacitor, 2V, 1000 μ F	10 x 10.5	Sanyo	6
C12,24,32,40,42, 44	1 μ F Ceramic	Ceramic Capacitor, Y5V, 25V, 1.0 μ F	1206	Any	6
C13,33,43	16SPS100M	OSCON Capacitor, 16V, 100 μ F	6.3 x 9.8	Sanyo	3
C45,47-49,51-53, 55-57, 59-61,63-65, 67-80	1 μ F Ceramic	Ceramic Capacitor, Y5V, 16V, 1.0 μ F	0805	Any	30
C4	Spare		0805		
C81-90	Spare		10mm		
CR1	67-1372-1-ND	Miniature R/G LED, Surface Mount Indicator	2.8 x 3.4	Digikey	1
J1,2	111-0702-001	Binding Post, Through Hole, Screw-on, Red		Johnson Components	2
J3	111-0703-001	Binding Post, Through Hole, Screw-On, Black		Johnson Components	1
J4,5	KPA8CTP	Cable to Pad Mechanical Terminal		Burndy	2
J6	39-29-9203	20-pin Mini-Fit, Jr. TM Header Connector		Molex	1
J7	39-29-9042	4-pin Mini-Fit, Jr. Header Connector		Molex	1
J8	67276-3700	PGA423 ZIF Connector		Molex	1
JP1-3	68000-236	Jumper Header	0.1" Spacing	Berg	16/36
	71363-102	Jumper Shunt	0.1" Spacing	Berg	7
L1	1.2 μ H Inductor	Inductor, 6T of 16AWG on T44-52 Core	8 x 13		1
L2-4	0.85 μ H Inductor	Inductor, 6T of 14AWG on T50-8B/90 Core	11 x 18		3
Q1	BSS123CT-ND	Logic N-MOSFET, 100V, 6 Ω	SOT-23	Digikey	1
Q2,4,6	HUF76132P3	UltraFET TM MOSFET, 30V, 11m Ω	TO-220	Intersil	3
	591302B02800	Self-Locking Black Anodized Heatsink		Aavid	3
Q3,5,7	HUF76143S3S	UltraFET MOSFET, 30V, 5.5m Ω	TO-263	Intersil	3
R1-3	2.49k Ω	Resistor, 1%, 0.1W	0603	Any	3
R4	137k Ω	Resistor, 1%, 0.1W	0603	Any	1
R6	15k Ω	Resistor, 5%, 0.1W	0603	Any	1
R7	2.67k Ω	Resistor, 1%, 0.1W	0603	Any	1
R9,11	1k Ω	Resistor, 5%, 0.1W	0603	Any	2
R10	10k Ω	Resistor, 5%, 0.1W	0603	Any	1
R5,8,12,13	Spare		0603		
TP1-5,10	SPCJ-123-01	Test Point		Jolo	6
TP6,7,9,11	1514-2	Terminal Post		Keystone	4
TP8	1314353-00	Test Point, Scope Probe		Tektronics	1
U1	HIP6301CB	Multiphase Buck PWM Controller	SOIC-20	Intersil	1
U2-4	HIP6601ACB	Synchronous-Rectified Buck MOSFET Driver	SO-8	Intersil	3

HIP6301EVAL2 Layout

TOP SILK SCREEN

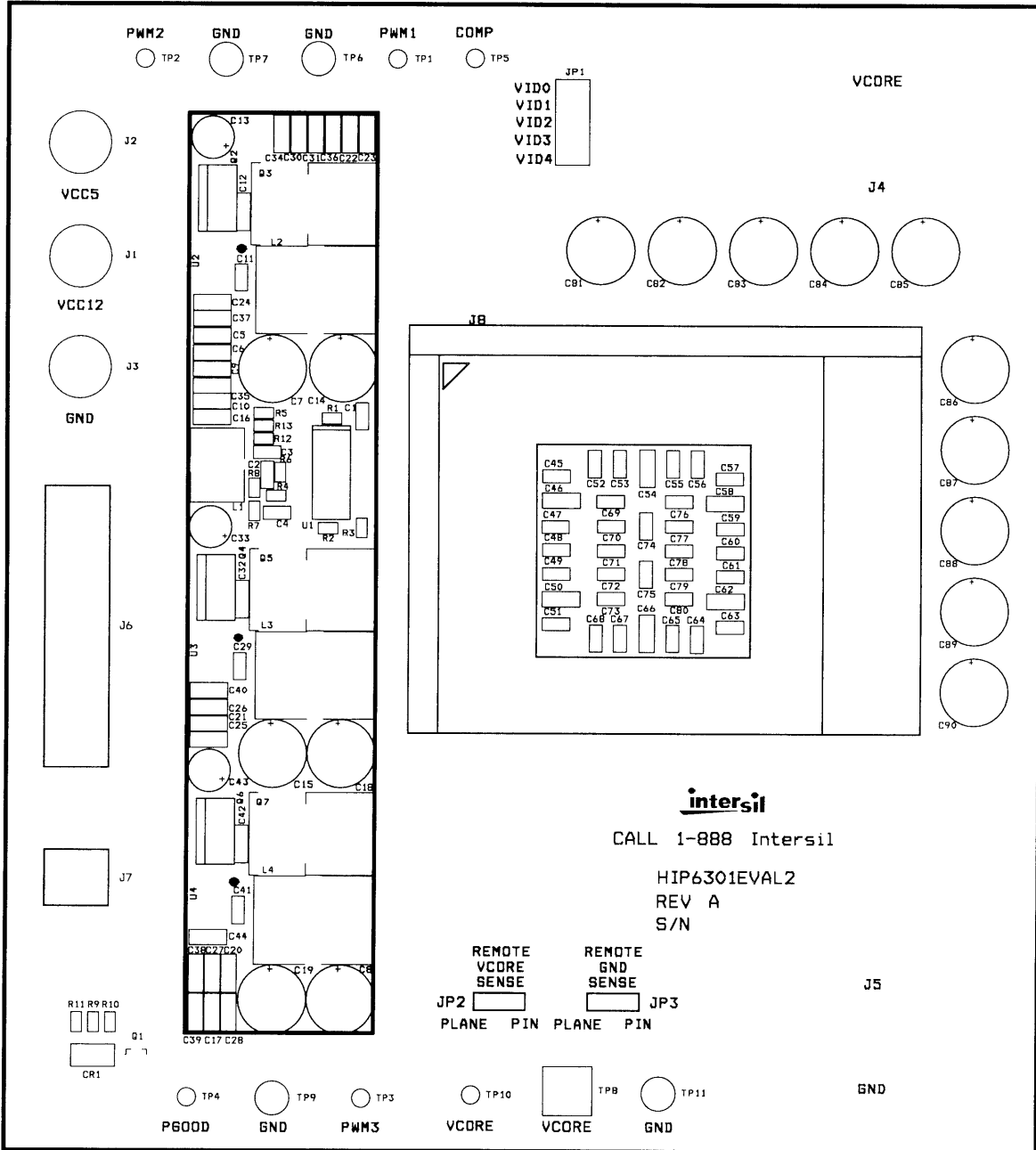

HIP6301EVAL2 Layout (Continued)

TOP LAYER

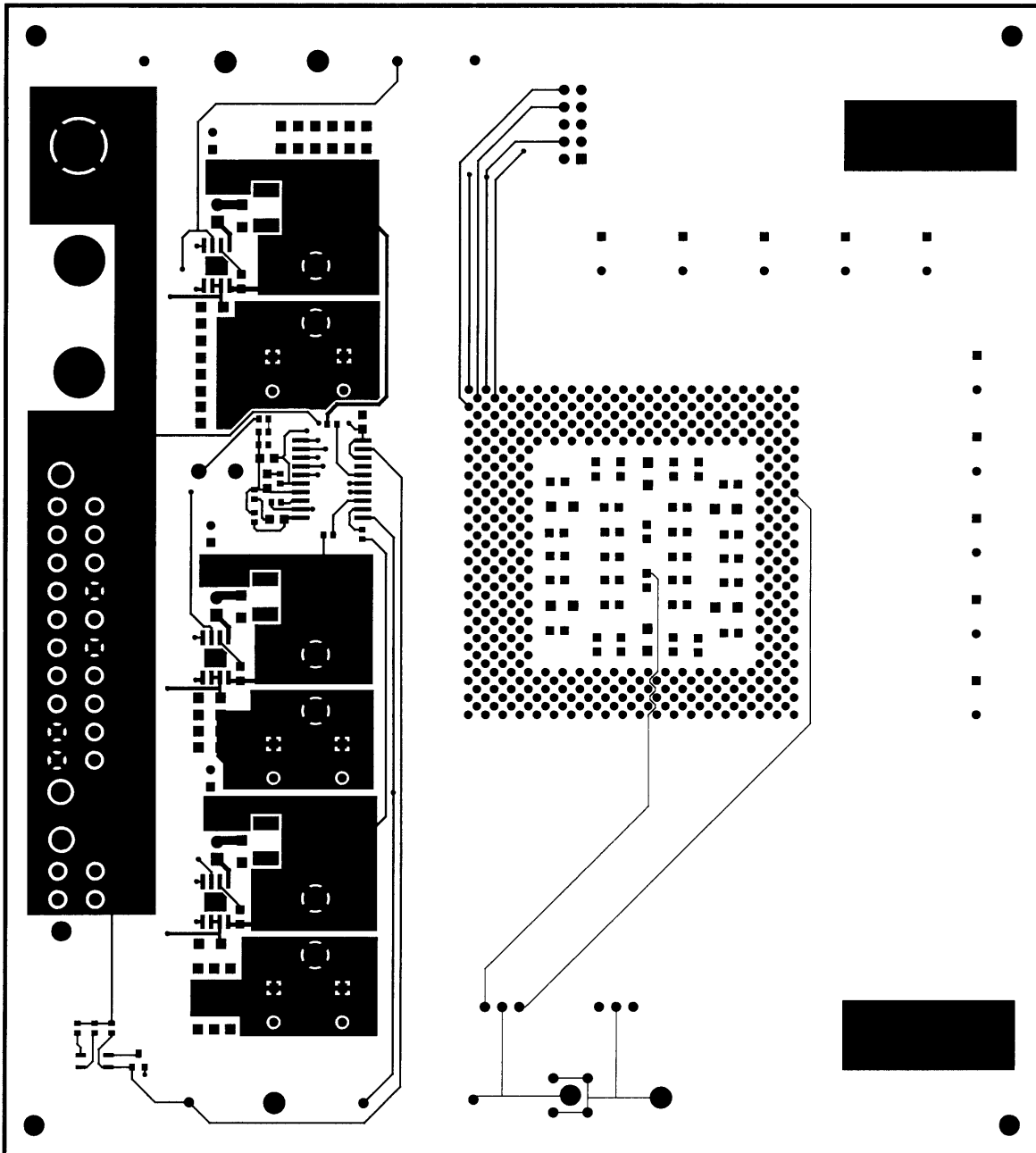

HIP6301EVAL2 Layout (Continued)

GROUND LAYER

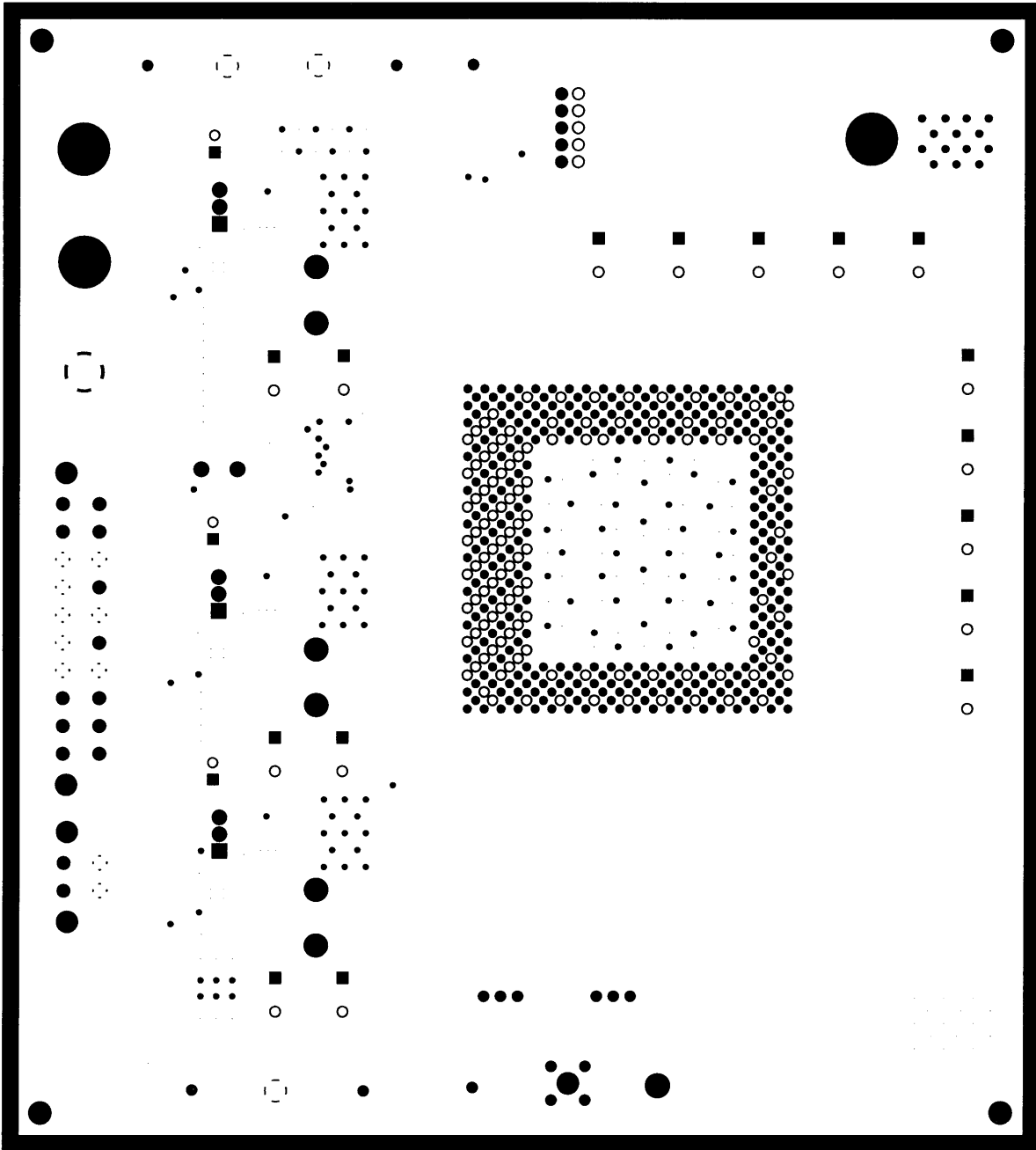

HIP6301EVAL2 Layout (Continued)

POWER LAYER

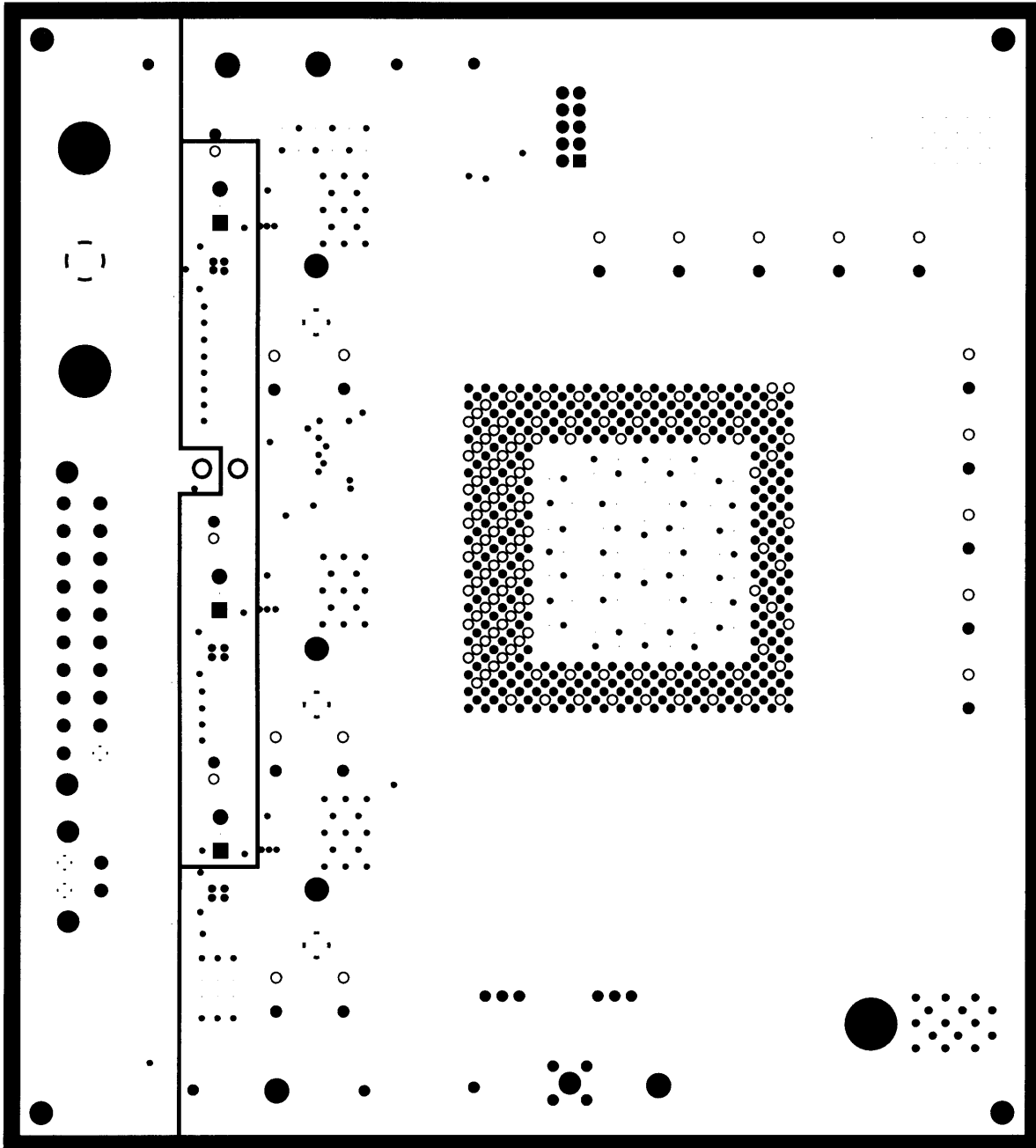

HIP6301EVAL2 Layout (Continued)

BOTTOM LAYER

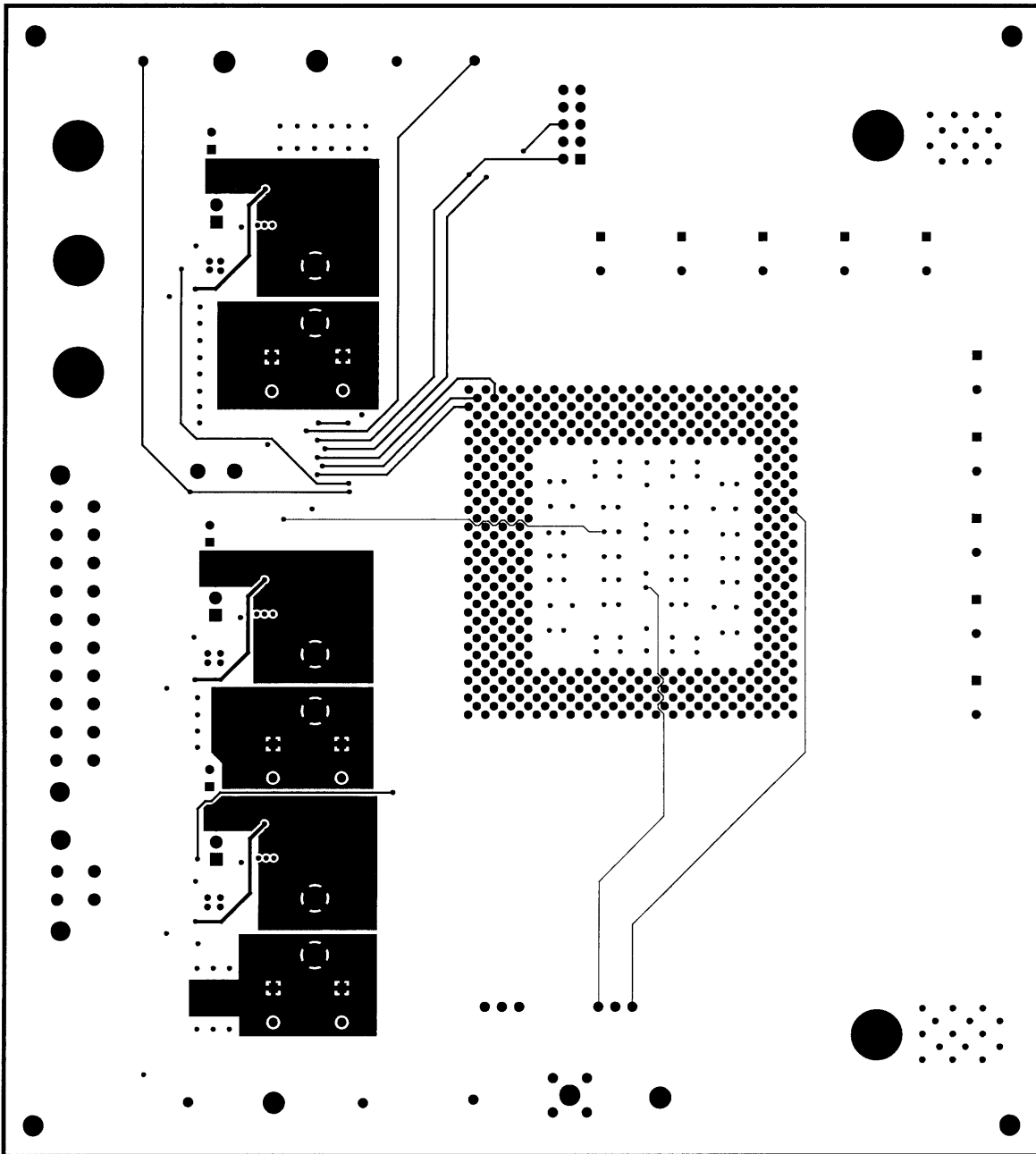

All Intersil U.S. products are manufactured, assembled and tested utilizing ISO9000 quality systems.
Intersil Corporation's quality certifications can be viewed at www.intersil.com/design/quality

Intersil products are sold by description only. Intersil Corporation reserves the right to make changes in circuit design, software and/or specifications at any time without notice. Accordingly, the reader is cautioned to verify that data sheets are current before placing orders. Information furnished by Intersil is believed to be accurate and reliable. However, no responsibility is assumed by Intersil or its subsidiaries for its use; nor for any infringements of patents or other rights of third parties which may result from its use. No license is granted by implication or otherwise under any patent or patent rights of Intersil or its subsidiaries.

For information regarding Intersil Corporation and its products, see www.intersil.com