

PART NAME

JUNCTION BOX w / KNOCKOUTS

PART No.

JB-3960-KO

REVISION DATE

7-18-11

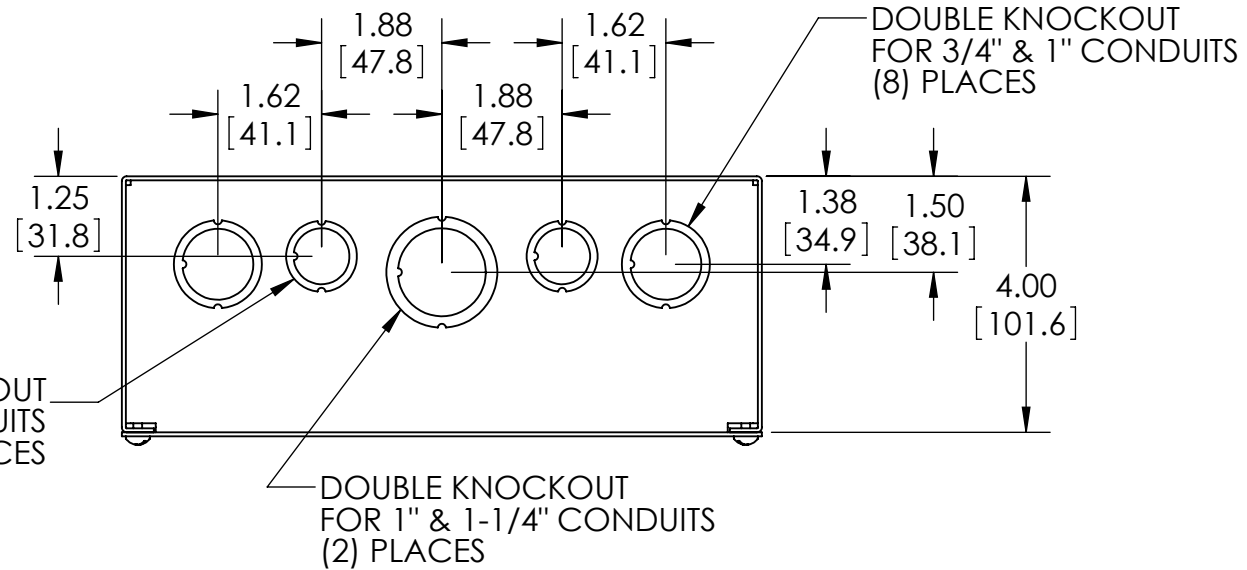

MATERIAL - 16 GA. [1.5mm] STEEL
 FINISH - SMOOTH GRAY POWDERCOAT

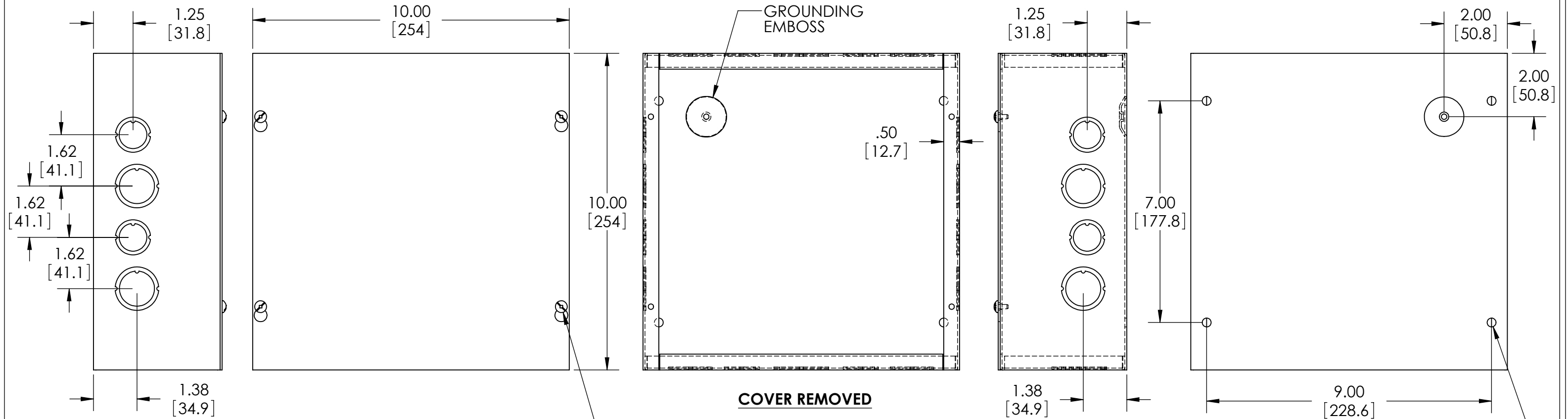
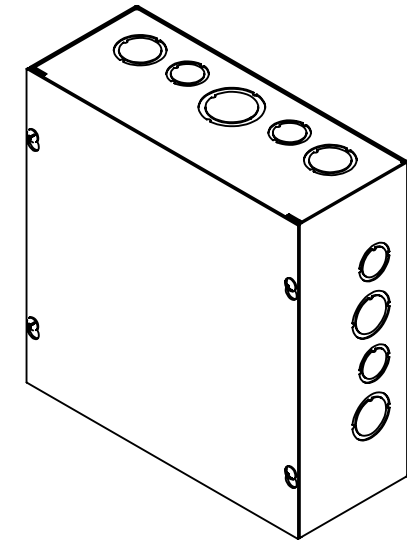

SCREWS: #10-32 x .31" [8mm] LG. MACHINE, PAN HEAD, SLOTTED/SQUARE COMBINATION STYLE DRIVE, STEEL, ZINC PLATED. (SUPPLIED FOR COVER MOUNTING AND FOR GROUND POINT).

