

## Normally – OFF Silicon Carbide Junction Transistor

$V_{DS}$	=	<b>600 V</b>
$R_{DS(ON)}$	=	<b>25 mΩ</b>
$I_D$ ( $T_C = 25^\circ\text{C}$ )	=	<b>100 A</b>
$h_{FE}$ ( $T_C = 25^\circ\text{C}$ )	=	<b>105</b>

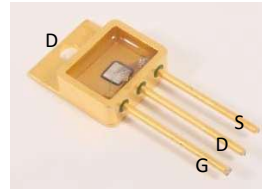
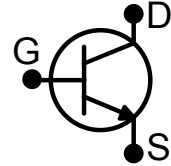
### Features

- 210°C maximum operating temperature
- Gate Oxide Free SiC Switch
- Exceptional Safe Operating Area
- Excellent Gain Linearity
- Compatible with 5 V TTL Gate Drive
- Temperature Independent Switching Performance
- Low Output Capacitance
- Positive Temperature Coefficient of  $R_{DS,ON}$
- Suitable for Connecting an Anti-parallel Diode

### Advantages

- Compatible with Si MOSFET/IGBT Gate Drive ICs
- > 20 μs Short-Circuit Withstand Capability
- Lowest-in-class Conduction Losses
- High Circuit Efficiency
- Minimal Input Signal Distortion
- High Amplifier Bandwidth

### Package


**TO-258**


### Applications

- Down Hole Oil Drilling
- Geothermal Instrumentation
- Solenoid Actuators
- General Purpose High-Temperature Switching
- Amplifiers
- Solar Inverters
- Switched-Mode Power Supply (SMPS)
- Power Factor Correction (PFC)

## Table of Contents

<b>Section I: Absolute Maximum Ratings</b> .....	<b>1</b>
<b>Section II: Static Electrical Characteristics</b> .....	<b>2</b>
<b>Section III: Dynamic Electrical Characteristics</b> .....	<b>2</b>
<b>Section IV: Figures</b> .....	<b>3</b>
<b>Section V: Driving the GA50JT06-247</b> .....	<b>7</b>
<b>Section VI: Package Dimensions</b> .....	<b>10</b>
<b>Section VII: SPICE Model Parameters</b> .....	<b>11</b>

### Section I: Absolute Maximum Ratings

Parameter	Symbol	Conditions	Value	Unit	Notes
Drain – Source Voltage	$V_{DS}$	$V_{GS} = 0\text{ V}$	600	V	
Continuous Drain Current	$I_D$	$T_J = 210^\circ\text{C}, T_C = 25^\circ\text{C}$	100	A	
Continuous Gate Current	$I_{GM}$		3.5	A	
Turn-Off Safe Operating Area	RBSOA	$T_J = 210^\circ\text{C}, I_G = 3.5\text{ A},$ Clamped Inductive Load	$I_{D,max} = 50$ @ $V_{DS} \leq V_{DSmax}$	A	Fig. 18
Short Circuit Safe Operating Area	SCSOA	$T_J = 210^\circ\text{C}, I_G = 3.5\text{ A}, V_{DS} = 400\text{ V},$ Non Repetitive	>20	μs	
Reverse Gate – Source Voltage	$V_{SG}$		30	V	
Reverse Drain – Source Voltage	$V_{SD}$		25	V	
Power Dissipation	$P_{tot}$	$T_J = 210^\circ\text{C}, T_C = 25^\circ\text{C}$	769	W	Fig. 16
Operating and Storage Temperature	$T_{stg}$		-55 to 210	°C	

**Section II: Static Electrical Characteristics**

Parameter	Symbol	Conditions	Value			Unit	Notes
			Min.	Typical	Max.		
<b>A: On State</b>							
Drain – Source On Resistance	$R_{DS(ON)}$	$I_D = 50\text{ A}, T_J = 25\text{ }^\circ\text{C}$		25		mΩ	Fig. 5
		$I_D = 50\text{ A}, T_J = 125\text{ }^\circ\text{C}$		39			
		$I_D = 50\text{ A}, T_J = 175\text{ }^\circ\text{C}$		43			
		$I_D = 50\text{ A}, T_J = 210\text{ }^\circ\text{C}$		50			
Gate – Source Saturation Voltage	$V_{GS,SAT}$	$I_D = 50\text{ A}, I_D/I_G = 40, T_J = 25\text{ }^\circ\text{C}$		3.42		V	Fig. 7
		$I_D = 50\text{ A}, I_D/I_G = 30, T_J = 175\text{ }^\circ\text{C}$		3.23			
DC Current Gain	$h_{FE}$	$V_{DS} = 5\text{ V}, I_D = 50\text{ A}, T_J = 25\text{ }^\circ\text{C}$		105		–	Fig. 5
		$V_{DS} = 5\text{ V}, I_D = 50\text{ A}, T_J = 125\text{ }^\circ\text{C}$		77			
		$V_{DS} = 5\text{ V}, I_D = 50\text{ A}, T_J = 175\text{ }^\circ\text{C}$		71			
		$V_{DS} = 5\text{ V}, I_D = 50\text{ A}, T_J = 210\text{ }^\circ\text{C}$		70			
<b>B: Off State</b>							
Drain Leakage Current	$I_{DSS}$	$V_R = 600\text{ V}, V_{GS} = 0\text{ V}, T_J = 25\text{ }^\circ\text{C}$		10		μA	Fig. 8
		$V_R = 600\text{ V}, V_{GS} = 0\text{ V}, T_J = 125\text{ }^\circ\text{C}$		50			
		$V_R = 600\text{ V}, V_{GS} = 0\text{ V}, T_J = 210\text{ }^\circ\text{C}$		100			
Gate Leakage Current	$I_{SG}$	$V_{SG} = 20\text{ V}, T_J = 25\text{ }^\circ\text{C}$		20		nA	

**C: Thermal**

Thermal resistance, junction - case	$R_{thJC}$		0.26		$^\circ\text{C/W}$	Fig. 19
-------------------------------------	------------	--	------	--	--------------------	---------

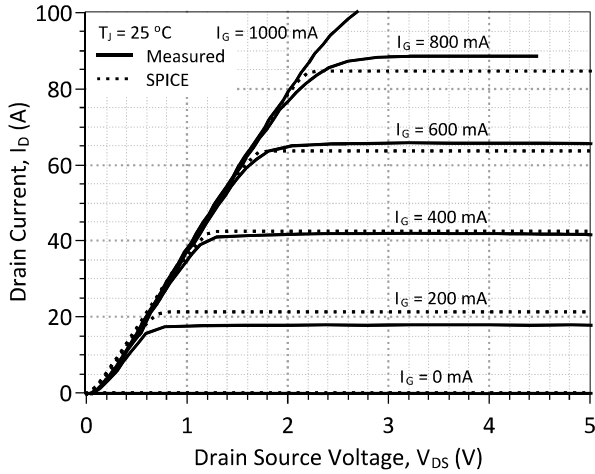
**Section III: Dynamic Electrical Characteristics**

Parameter	Symbol	Conditions	Value			Unit	Notes
			Min.	Typical	Max.		
<b>A: Capacitance and Gate Charge</b>							
Input Capacitance	$C_{iss}$	$V_{GS} = 0\text{ V}, V_D = 100\text{ V}, f = 1\text{ MHz}$		6450		pF	Fig. 9
Reverse Transfer/Output Capacitance	$C_{rss}/C_{oss}$	$V_D = 100\text{ V}, f = 1\text{ MHz}$		420		pF	Fig. 9
Output Capacitance Stored Energy	$E_{OSS}$	$V_{GS} = 0\text{ V}, V_D = 400\text{ V}, f = 1\text{ MHz}$		17.4		μJ	Fig. 10
Effective Output Capacitance, time related	$C_{oss,tr}$	$I_D = \text{constant}, V_{GS} = 0\text{ V}, V_{DS} = 0\dots 400\text{ V}$		390		pF	
Effective Output Capacitance, energy related	$C_{oss,er}$	$V_{GS} = 0\text{ V}, V_{DS} = 0\dots 400\text{ V}$		284		pF	
Gate-Source Charge	$Q_{GS}$	$V_{GS} = -5\dots 3\text{ V}$		55		nC	
Gate-Drain Charge	$Q_{GD}$	$V_{GS} = 0\text{ V}, V_{DS} = 0\dots 400\text{ V}$		156		nC	
Gate Charge - Total	$Q_G$			211		nC	
<b>B: Switching<sup>1</sup></b>							
Internal Gate Resistance – zero bias	$R_{G(INT-ZERO)}$	$f = 1\text{ MHz}, V_{AC} = 50\text{ mV}, V_{DS} = 0\text{ V}, V_{GS} = 0\text{ V}, T_J = 210\text{ }^\circ\text{C}$		0.9		Ω	
Internal Gate Resistance – ON	$R_{G(INT-ON)}$	$V_{GS} > 2.5\text{ V}, V_{DS} = 0\text{ V}, T_J = 210\text{ }^\circ\text{C}$		0.09		Ω	
Turn On Delay Time	$t_{d(on)}$	$T_J = 25\text{ }^\circ\text{C}, V_{DS} = 400\text{ V},$		25		ns	
Fall Time, $V_{DS}$	$t_f$	$I_D = 50\text{ A}, \text{Resistive Load}$		44		ns	Fig. 11,13
Turn Off Delay Time	$t_{d(off)}$	Refer to Section V for additional driving information.		40		ns	
Rise Time, $V_{DS}$	$t_r$			33		ns	Fig. 12,14
Turn On Delay Time	$t_{d(on)}$			19		ns	
Fall Time, $V_{DS}$	$t_f$	$T_J = 210\text{ }^\circ\text{C}, V_{DS} = 400\text{ V},$		43		ns	Fig. 11
Turn Off Delay Time	$t_{d(off)}$	$I_D = 50\text{ A}, \text{Resistive Load}$		89		ns	
Rise Time, $V_{DS}$	$t_r$			27		ns	Fig. 12
Turn-On Energy Per Pulse	$E_{on}$	$T_J = 25\text{ }^\circ\text{C}, V_{DS} = 400\text{ V},$		690		μJ	Fig. 11,13
Turn-Off Energy Per Pulse	$E_{off}$	$I_D = 50\text{ A}, \text{Inductive Load}$		359		μJ	Fig. 12,14
Total Switching Energy	$E_{tot}$	Refer to Section V.		1049		μJ	
Turn-On Energy Per Pulse	$E_{on}$			758		μJ	Fig. 11
Turn-Off Energy Per Pulse	$E_{off}$	$T_J = 210\text{ }^\circ\text{C}, V_{DS} = 400\text{ V},$		337		μJ	Fig. 12
Total Switching Energy	$E_{tot}$	$I_D = 50\text{ A}, \text{Inductive Load}$		1095		μJ	

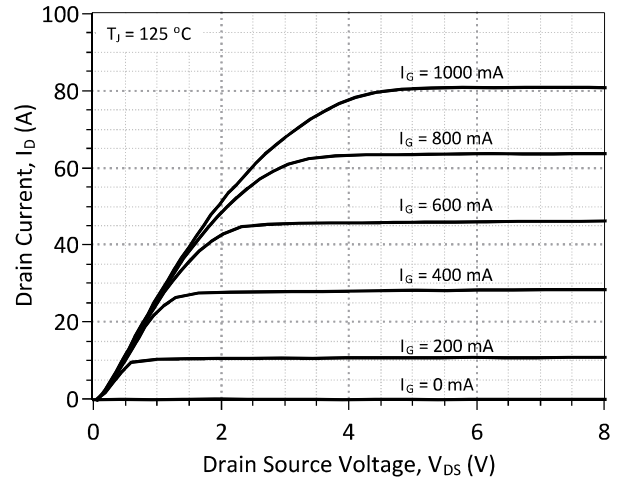
<sup>1</sup> – All times are relative to the Drain-Source Voltage  $V_{DS}$

**Section IV: Figures**

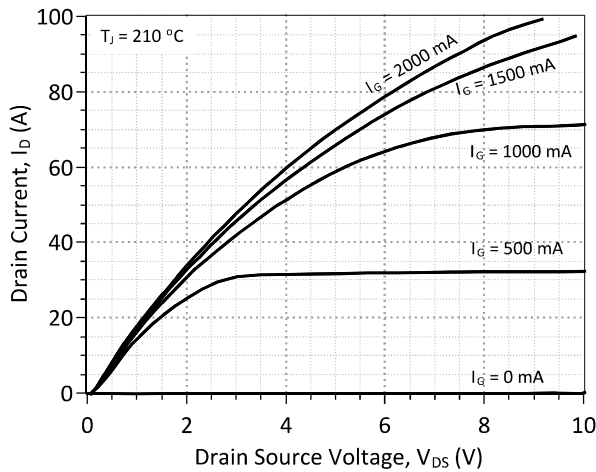
**A: Static Characteristics**



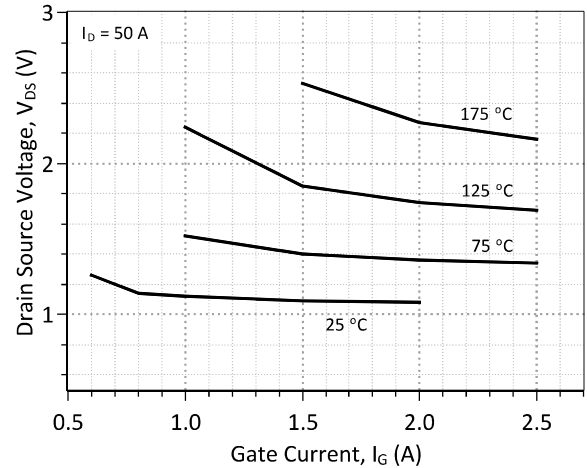
**Figure 1: Typical Output Characteristics at 25 °C**



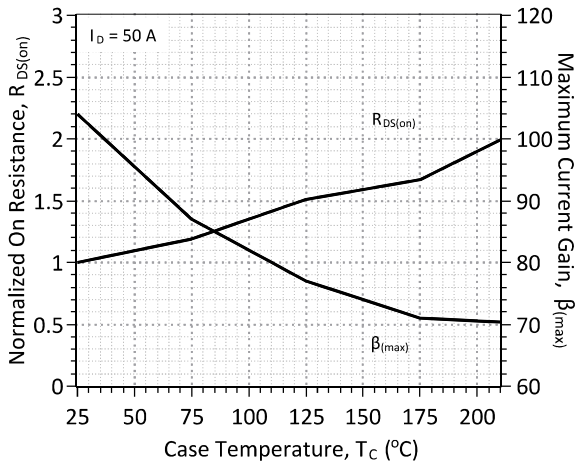
**Figure 2: Typical Output Characteristics at 125 °C**



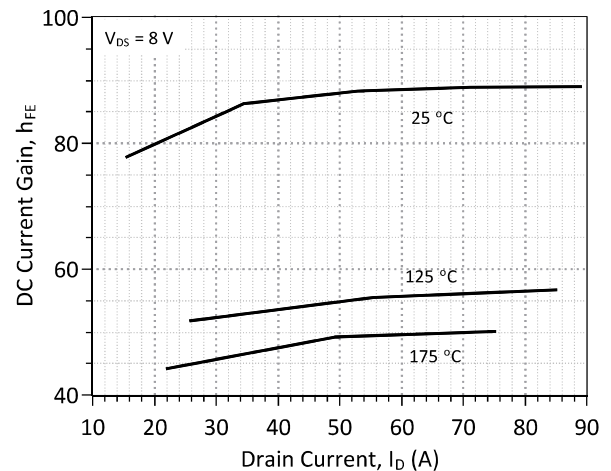
**Figure 3: Typical Output Characteristics at 210 °C**



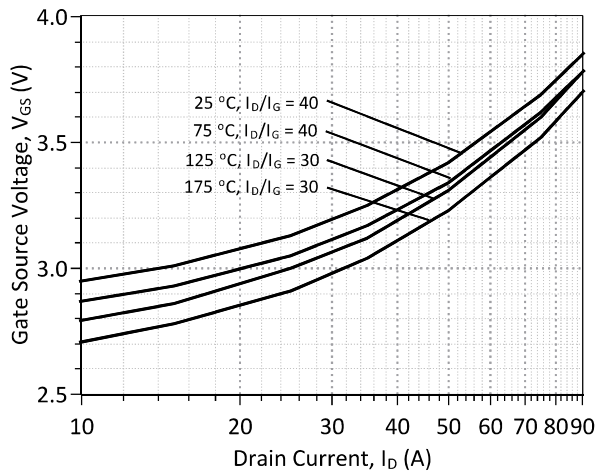
**Figure 4: Drain-Source Voltage vs. Gate Current**



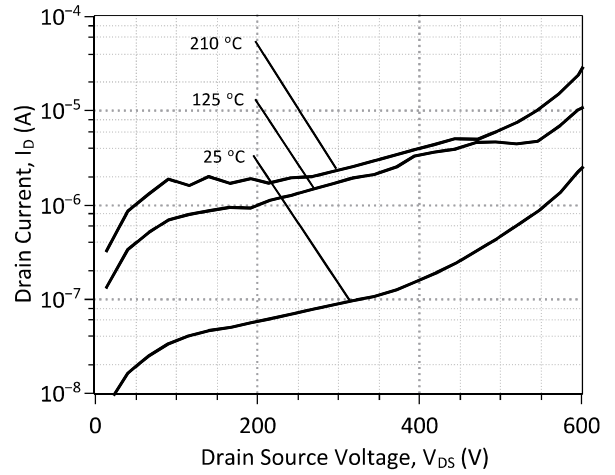
**Figure 5: Normalized On-Resistance and Current Gain vs. Temperature**



**Figure 6: DC Current Gain vs. Drain Current**

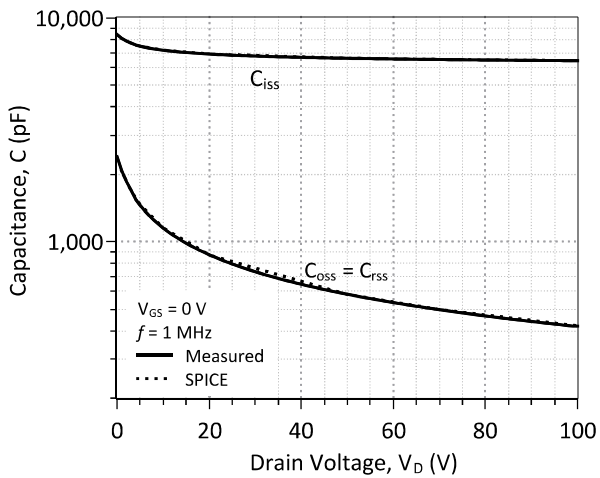


**Figure 7: Typical Gate – Source Saturation Voltage**

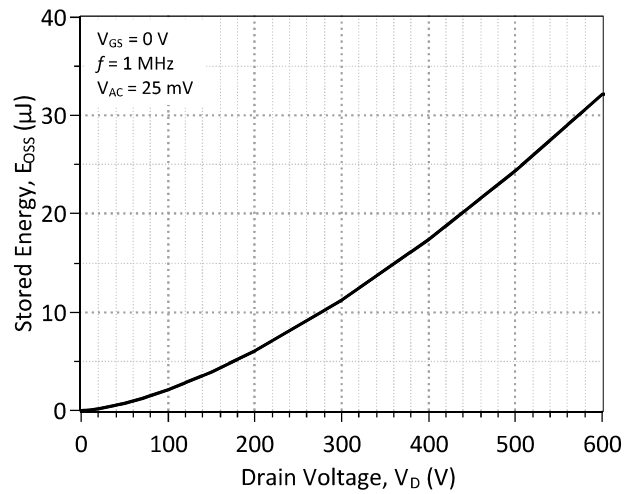


**Figure 8: Typical Blocking Characteristics**

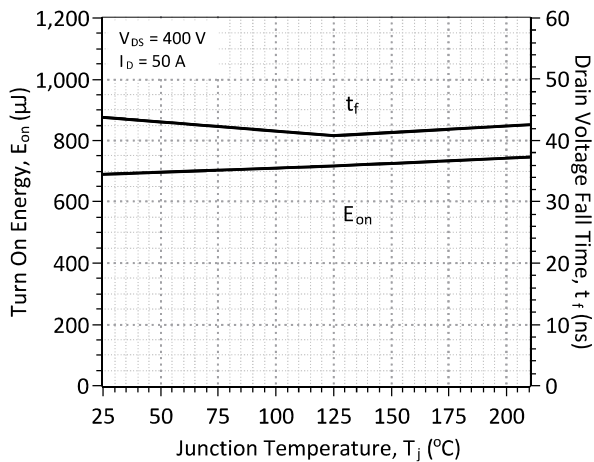
**B: Dynamic Characteristics**



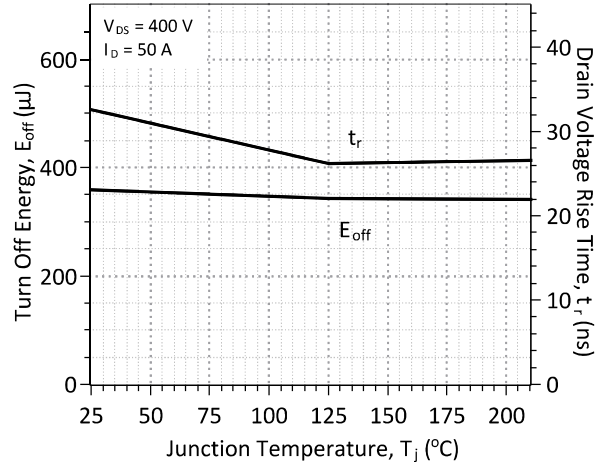
**Figure 9: Input, Output, and Reverse Transfer Capacitance**



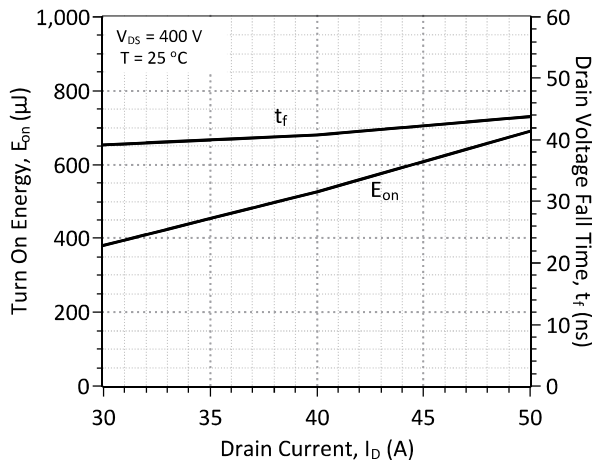
**Figure 10: Output Capacitance Stored Energy**



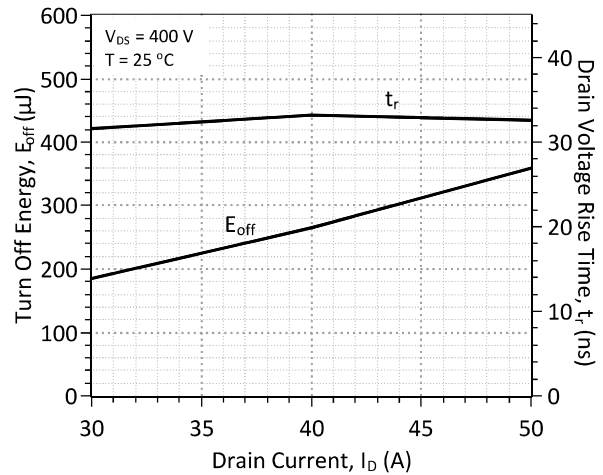
**Figure 11: Typical Turn On Energy Losses and Switching Times vs. Temperature**



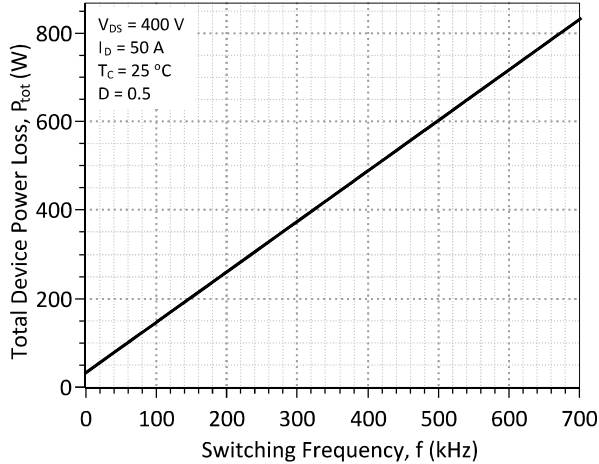
**Figure 12: Typical Turn Off Energy Losses and Switching Times vs. Temperature**



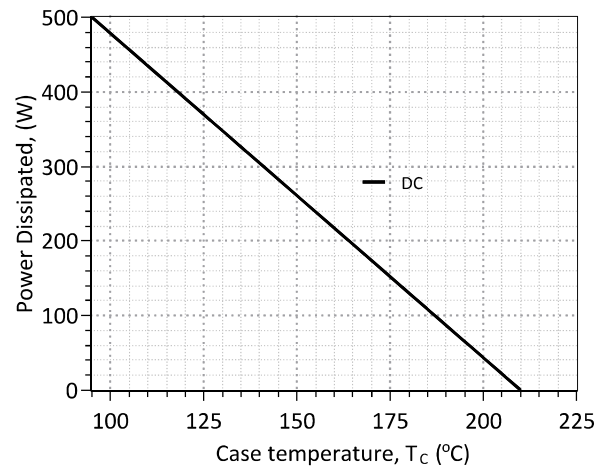
**Figure 13: Typical Turn On Energy Losses and Switching Times vs. Drain Current**



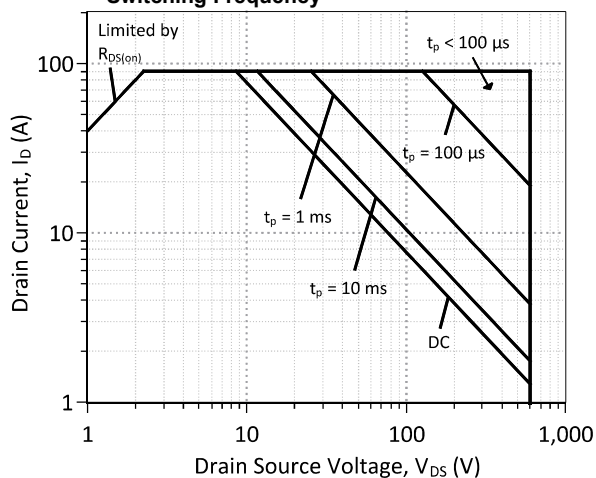
**Figure 14: Typical Turn Off Energy Losses and Switching Times vs. Drain Current**



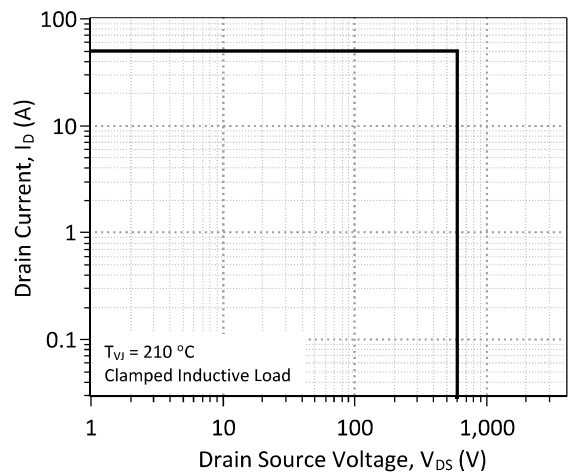
**Figure 15: Typical Hard Switched Device Power Loss vs. Switching Frequency<sup>2</sup>**



**Figure 16: Power Derating Curve**

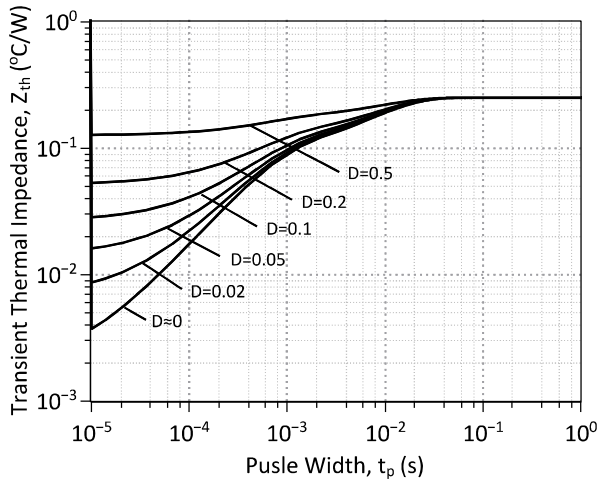


**Figure 17: Forward Bias Safe Operating Area at T<sub>C</sub> = 25 °C**

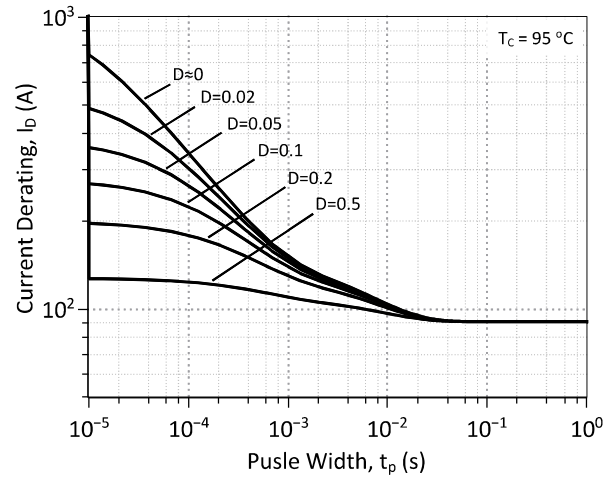


**Figure 18: Turn-Off Safe Operating Area**

<sup>2</sup> – Representative values based on device conduction and switching loss. Actual losses will depend on gate drive conditions, device load, and circuit topology.



**Figure 19: Transient Thermal Impedance**



**Figure 20: Drain Current Derating vs. Pulse Width**

## Section V: Driving the GA50JT06-247

The GA50JT06-247 is a current controlled SiC transistor which requires a positive gate current for turn-on and to remain in on-state. It may be driven by different drive topologies depending on the intended application.

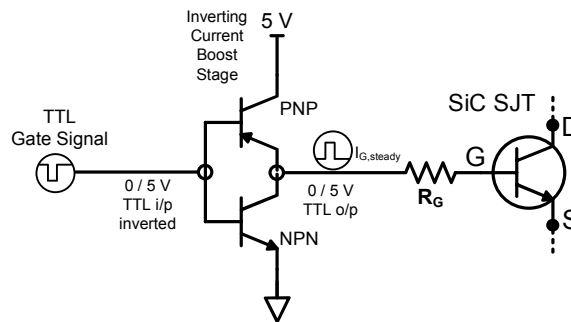
**Table 1: Estimated Power Consumption and switching frequencies for various Gate Drive topologies.**

Drive Topology	Gate Drive Power Consumption	Switching Frequency
Simple TTL	High	Low
Constant Current	Medium	Medium
High Speed – Boost Capacitor	Medium	High
High Speed – Boost Inductor	Low	High
Proportional	Lowest	Medium
Pulsed Power	Medium	N/A

### A: Simple TTL Drive

The GA50JT06-247 may be driven by 5 V TTL logic by using a simple current amplification stage. The current amplifier output current must meet or exceed the steady state gate current,  $I_{G,steady}$ , required to operate the GA50JT06-247. An external gate resistor  $R_G$ , shown in the Figure 21 topology, sets  $I_{G,steady}$  to the required level which is dependent on the SJT drain current  $I_D$  and DC current gain  $h_{FE}$ ,  $R_G$  may be calculated from the equation below. The values of  $h_{FE}$  and  $V_{GS,sat}$  may be read from Figure 6 and Figure 7, respectively.  $V_{EC,sat}$  can be taken from the PNP datasheet, a partial list of high-temperature PNP and NPN transistors options is given below. High-temperature MOSFETs may also be used in the topology.

$$R_{G,max} = \frac{(5.0\text{ V} - V_{EC,sat}(PNP) - V_{GS,sat}(SJT)) * h_{FE}(T, I_D)}{I_D * 1.5}$$



**Figure 21: Simple TTL Gate Drive Topology**

**Table 2: Partial List of High-Temperature BJTs for TTL Gate Driving**

BJT Part Number	Type	$T_{j,max}$ (°C)
PHPT60603PY	PNP	175
PHPT60603NY	NPN	175
2N2222	NPN	200
2N6730	PNP	200
2N2905	PNP	200
2N5883	PNP	200
2N5885	NPN	200

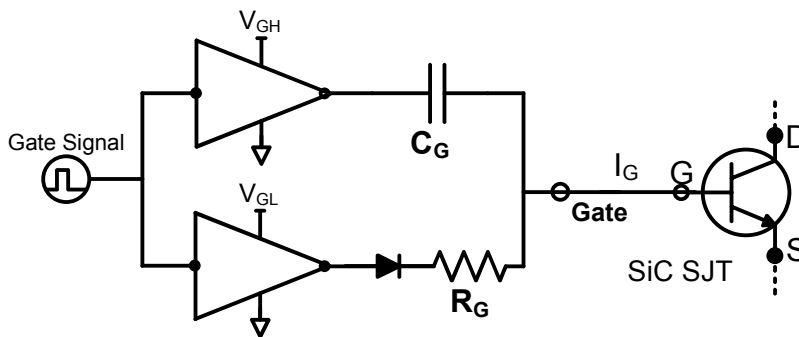
**B: High Speed Driving**

For ultra high speed GA50JT06-247 switching ( $t_r, t_f < 20$  ns) while maintaining low gate drive losses the supplied gate current should include a positive current peak during turn-on, a negative voltage peak during turn-off, and continuous gate current  $I_G$  to remain on.

An SJT is rapidly switched from its blocking state to on-state, when the necessary gate charge for turn-on,  $Q_G$ , is supplied by a burst of high gate current until the gate-source capacitance,  $C_{GS}$ , and gate-drain capacitance,  $C_{GD}$ , are fully charged. Ideally, the burst should terminate when the drain voltage has fallen to its on-state value in order to avoid unnecessary drive losses. A negative voltage peak is recommended for the turn-off transition in order to ensure that the gate current is not being supplied under high  $dV/dt$  due to the Miller effect. While satisfactory turn off can be achieved with  $V_{GS} = 0$  V, a negative  $V_{GS}$  value may be used in order to speed up the turn-off transition.

**B:1: High Speed, Low Loss Drive with Boost Capacitor**

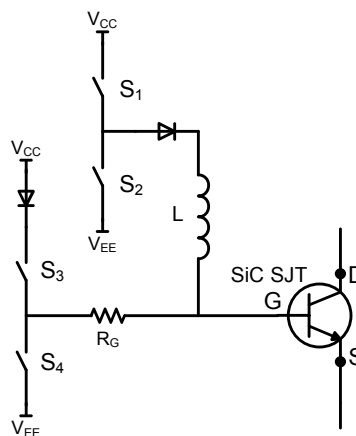
The GA50JT06-247 may be driven using a High Speed, Low Loss Drive with Boost Capacitor topology in which multiple voltage levels, a gate resistor, and a gate capacitor are used to provide current peaks at turn-on and turn-off for fast switching and a continuous gate current while in on-state. As shown in Figure 22, in this topology two gate driver ICs are utilized. An external gate resistor  $R_G$  is driven by a low voltage driver to supply the continuous gate current throughout on-state, and a gate capacitor  $C_G$  is driven at a higher voltage level to supply a high current peak at turn-on and turn-off. A 3 kV isolated evaluation gate drive board (GA03IDDJT30-FR4) from GeneSiC Semiconductor utilizing this topology is commercially available for high and low-side driving, its datasheet provides additional details about this drive topology.



**Figure 22: High Speed, Low Loss Drive with Boost Capacitor Topology**

**B:2: High Speed, Low Loss Drive with Boost Inductor**

A High Speed, Low-Loss Driver with Boost Inductor is also capable of driving the GA50JT06-247 at high-speed. It utilizes a gate drive inductor instead of a capacitor to provide the high-current gate current pulses  $I_{G,on}$  and  $I_{G,off}$ . During operation, inductor  $L$  is charged to a specified  $I_{L}$  current value then made to discharge  $I_L$  into the SJT gate pin using logic control of  $S_1, S_2, S_3,$  and  $S_4$ , as shown in Figure 23. After turn on, while the device remains on the necessary steady state gate current  $I_{G,steady}$  is supplied from source  $V_{CC}$  through  $R_G$ . Please refer to the article "A current-source concept for fast and efficient driving of silicon carbide transistors" by Dr. Jacek Rąbkowski for additional information on this driving topology.<sup>3</sup>



**Figure 23: High Speed, Low-Loss Driver with Boost Inductor Topology**

<sup>3</sup> – Archives of Electrical Engineering. Volume 62, Issue 2, Pages 333–343, ISSN (Print) 0004-0746, DOI: 10.2478/ae-2013-0026, June 2013

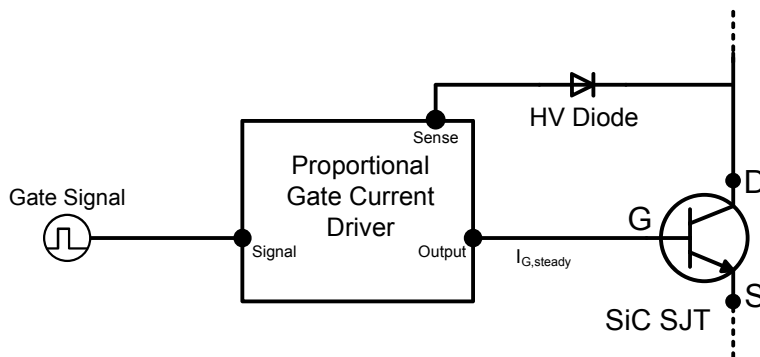


**C: Proportional Gate Current Driving**

A proportional gate drive topology may be beneficial for applications in which the GA50JT06-247 will operate over a wide range of drain current conditions to lower the gate drive power consumption. A proportional gate driver relies on instantaneous drain current  $I_D$  feedback to vary the steady state gate current  $I_{G,steady}$  supplied to the GA50JT06-247.

**C:1: Voltage Controlled Proportional Driver**

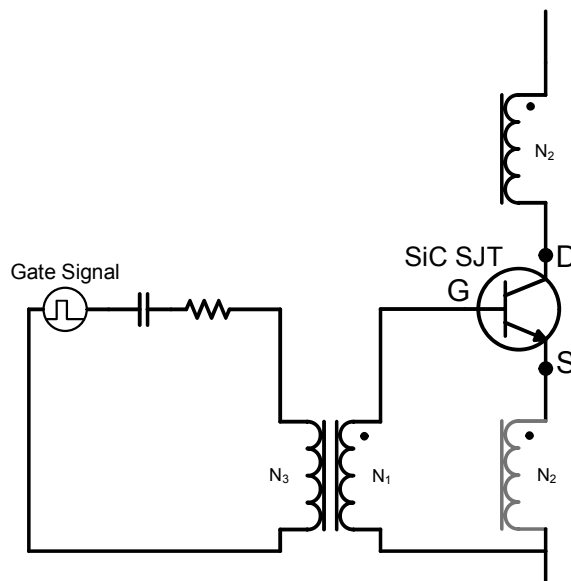
A voltage controlled proportional driver relies on a gate drive integrated circuit to detect the GA50JT06-247 drain-source voltage  $V_{DS}$  during on-state to sense  $I_D$ . The integrated circuit will then increase or decrease  $I_G$  in response to  $I_D$ . This allows  $I_G$  and gate drive power consumption to reduce while  $I_D$  is low or for  $I_G$  to increase when  $I_D$  increases. A high voltage diode connected between the drain and sense protects the integrated circuit from high-voltage when blocking. A simplified version of this topology is shown in Figure 24. Additional information will be available in the future at <http://www.genesicsemi.com/references/product-notes/>.



**Figure 24: Simplified Voltage Controlled Proportional Driver**

**C:2: Current Controlled Proportional Driver**

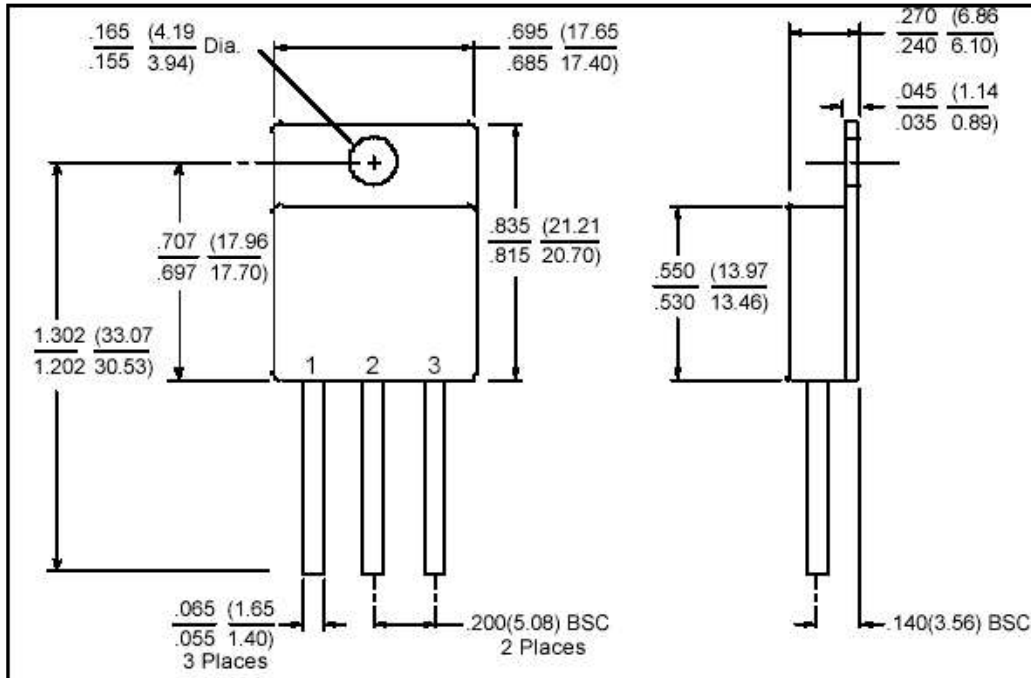
The current controlled proportional driver relies on a low-loss transformer in the drain or source path to provide feedback of the GA50JT06-247 drain current during on-state to supply  $I_{G,steady}$  into the gate.  $I_{G,steady}$  will increase or decrease in response to  $I_D$  at a fixed forced current gain which is set by the turns ratio of the transformer,  $h_{force} = I_D / I_G = N_2 / N_1$ . GA50JT06-247 is initially tuned-on using a gate current pulse supplied into an RC drive circuit to allow  $I_D$  current to begin flowing. This topology allows  $I_{G,steady}$  and the gate drive power consumption to reduce while  $I_D$  is relatively low or for  $I_{G,steady}$  to increase when  $I_D$  increases. A simplified version of this topology is shown in Figure 25. Additional information will be available in the future at <http://www.genesicsemi.com/references/product-notes/>.



**Figure 25: Simplified Current Controlled Proportional Driver**

Section VI: Package Dimensions

TO-258 PACKAGE OUTLINE



- NOTE**
1. CONTROLLED DIMENSION IS INCH. DIMENSION IN BRACKET IS MILLIMETER.
  2. DIMENSIONS DO NOT INCLUDE END FLASH, MOLD FLASH, MATERIAL PROTRUSIONS

Revision History			
Date	Revision	Comments	Supersedes
2014/12/12	5	Updated Electrical Characteristics	
2014/08/23	4	Updated Electrical Characteristics	
2014/04/10	3	Updated Electrical Characteristics	
2014/02/05	2	Updated Electrical Characteristics	
2013/12/19	1	Updated Gate Drive Section	
2013/12/05	0	Initial release	

Published by  
 GeneSiC Semiconductor, Inc.  
 43670 Trade Center Place Suite 155  
 Dulles, VA 20166

GeneSiC Semiconductor, Inc. reserves right to make changes to the product specifications and data in this document without notice.

GeneSiC disclaims all and any warranty and liability arising out of use or application of any product. No license, express or implied to any intellectual property rights is granted by this document.

Unless otherwise expressly indicated, GeneSiC products are not designed, tested or authorized for use in life-saving, medical, aircraft navigation, communication, air traffic control and weapons systems, nor in applications where their failure may result in death, personal injury and/or property damage.

**Section VII: SPICE Model Parameters**

This is a secure document. Please copy this code from the SPICE model PDF file on our website ([http://www.genesicsemi.com/images/hit\\_sic/sjt/GA50JT06-258\\_SPICE.pdf](http://www.genesicsemi.com/images/hit_sic/sjt/GA50JT06-258_SPICE.pdf)) into LTSPICE (version 4) software for simulation of the GA50JT06-258.

```
*      MODEL OF GeneSiC Semiconductor Inc.
*
*      $Revision:  1.3      $
*      $Date:    12-DEC-2014      $
*
*      GeneSiC Semiconductor Inc.
*      43670 Trade Center Place Ste. 155
*      Dulles, VA 20166
*
*      COPYRIGHT (C) 2014 GeneSiC Semiconductor Inc.
*      ALL RIGHTS RESERVED
*
* These models are provided "AS IS, WHERE IS, AND WITH NO WARRANTY
* OF ANY KIND EITHER EXPRESSED OR IMPLIED, INCLUDING BUT NOT LIMITED
* TO ANY IMPLIED WARRANTIES OF MERCHANTABILITY AND FITNESS FOR A
* PARTICULAR PURPOSE."
* Models accurate up to 2 times rated drain current.
*
.model GA50JT06 NPN
*
+ IS      5.00E-47
+ ISE     1.26E-26
+ EG      3.23
+ BF      106
+ BR      0.55
+ IKF     9000
+ NF      1
+ NE      2
+ RB      0.9
+ IRB     0.002
+ RBM     0.09
+ RE      0.01
+ RC      0.013
+ CJC     2.3989E-9
+ VJC     2.8346223
+ MJC     0.4846
+ CJE     6.026E-09
+ VJE     3.17915435
+ MJE     0.52951635
+ XTI     3
+ XTB     -1.2
+ TRC1    7.00E-3
+ VCEO    600
+ ICRATING 100
+ MFG     GeneSiC_Semiconductor
*
* End of GA50JT06 SPICE Model
```