

MATERIALS AND FINISHES

BODY, COUPLING NUT SEE TABLE
PLATED SEE TABLE

CONTACT BERYLLIUM COPPER
PLATED GOLD

INSULATOR TEFLON

GASKET SILICONE RUBBER

C RING BERYLLIUM COPPER

CRIMP TUBE BRASS
PLATED NICKEL

SHRINK TUBE
VERSAFIT 1/4

UL FILE E107635

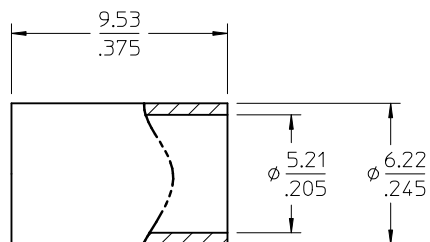
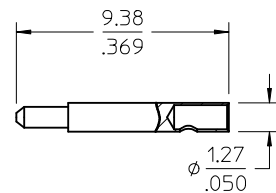
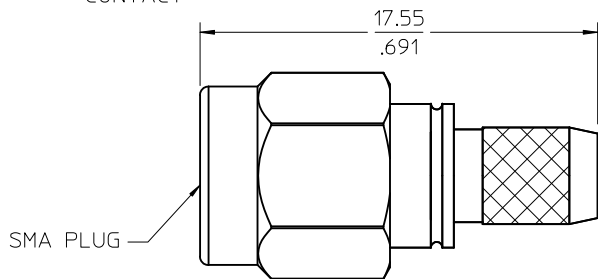
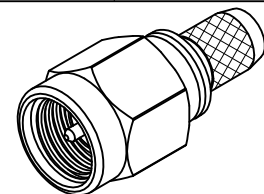
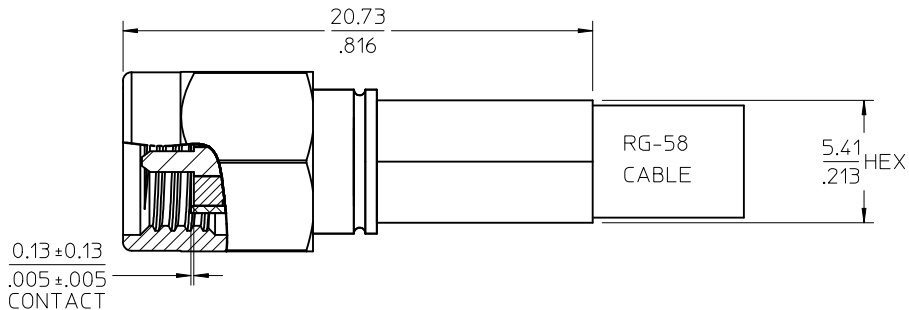

CRIMP TUBE

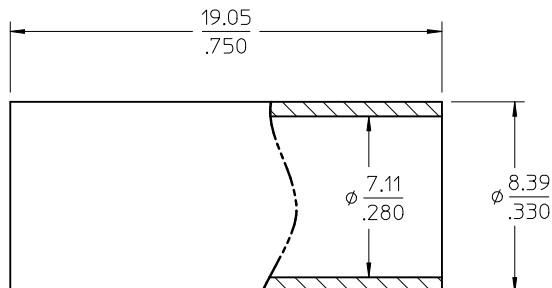

SHRINK TUBE

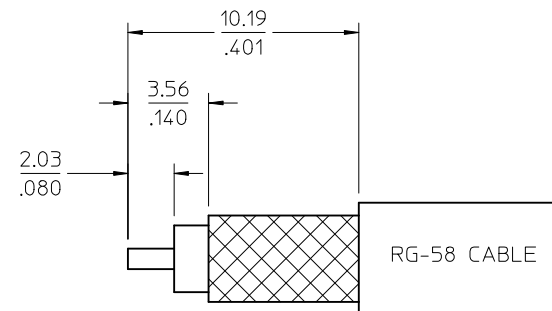

RECOMMENDED CABLE STRIP

PS-89675-3460	ELECTRICAL/MECHANICAL
MIL-STD-348A, FIG. 310.1	INTERFACE
SPECIFICATION	DESCRIPTION

73251-0134	73251-0132 ONE PER BAG
73251-0133	STAINLESS STEEL / PASSIVATE (20 CAVITY TRAY)
73251-0132	BRASS / NICKEL PLATE (BULK PACK)
73251-0131	STAINLESS STEEL / PASSIVATE (BULK PACK)
PART NO.	DESCRIPTION

CHG: 73251-0134
ADD: 73251-0134
PS WAS 89675-1160
EC NO: URF2012-0421
DRWN: WIENER 2012/01/25
CHKD: SSS 2012/01/25
APPR: WIENER 2012/01/27
A5

QUALITY SYMBOLS ▽=0 ▽=0	GENERAL TOLERANCES (UNLESS SPECIFIED)	DIMENSION STYLE MM/IN	SCALE	DESIGN UNITS METRIC	THIRD ANGLE PROJECTION
	4 PLACES ± --- ± --- 3 PLACES ± --- ± --- 2 PLACES ± --- ± --- 1 PLACE ± --- ± ---	DRAWN BY SSS DATE 2000/01/04	TITLE SMA PLUG, STR 50 OHMS, RG 58 SMA-PC	MOLEX INCORPORATED	
ANGULAR ± 2 °	DRAFT WHERE APPLICABLE MUST REMAIN WITHIN DIMENSIONS	APPROVED BY GMH DATE 2000/01/04	DOCUMENT NO. SD-73251-013	SHEET NO. 1 OF 1	
THIS DRAWING CONTAINS INFORMATION THAT IS PROPRIETARY TO MOLEX INCORPORATED AND SHOULD NOT BE USED WITHOUT WRITTEN PERMISSION					