



PART NAME

SNAP UTILITY BOX

PART No.

CU-18430-B CU-18430-W

REVISION DATE

10-7-14

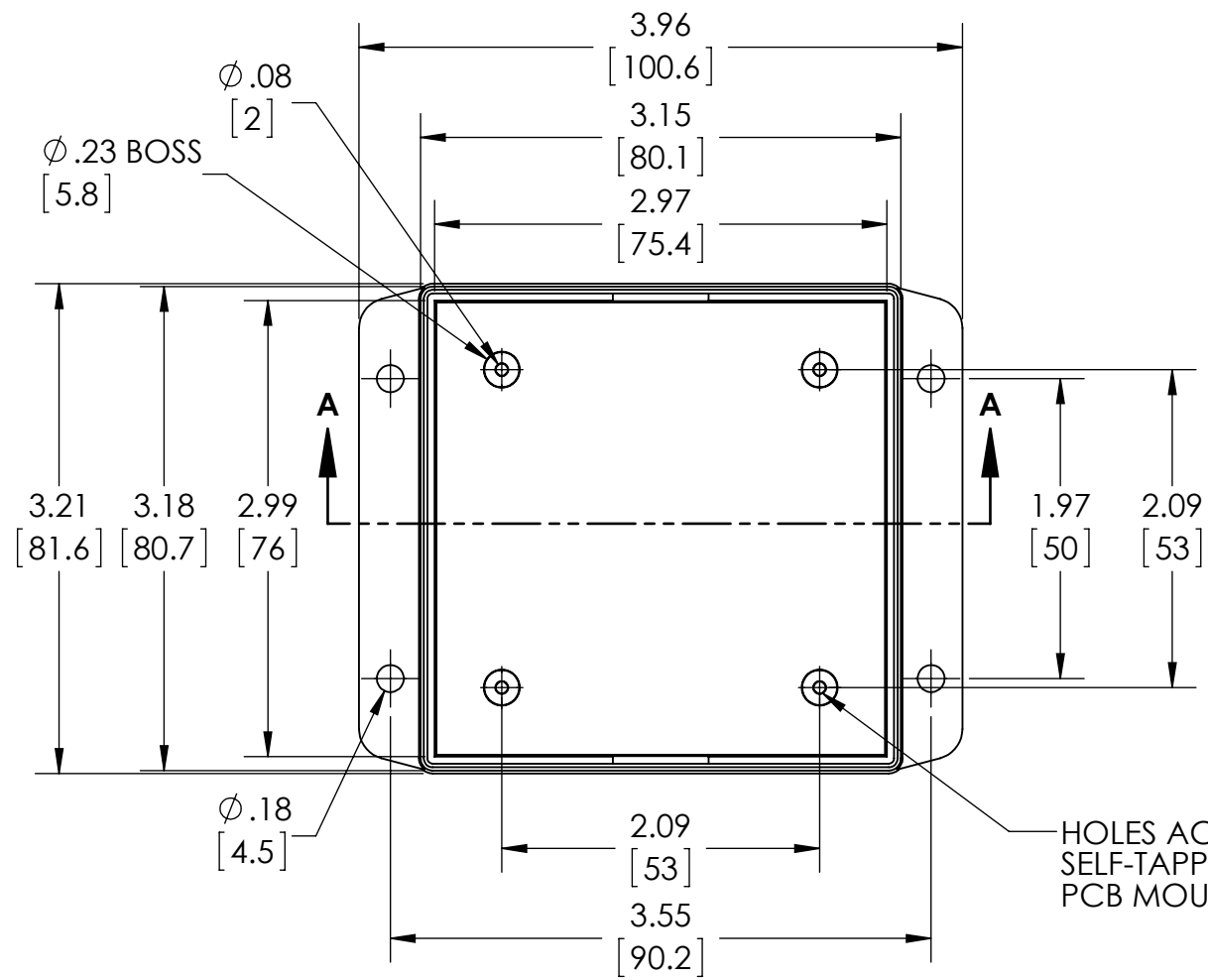

HOLES ACCEPT M2.6 x 6mm LG. SELF-TAPPING SCREWS FOR PCB MOUNTING

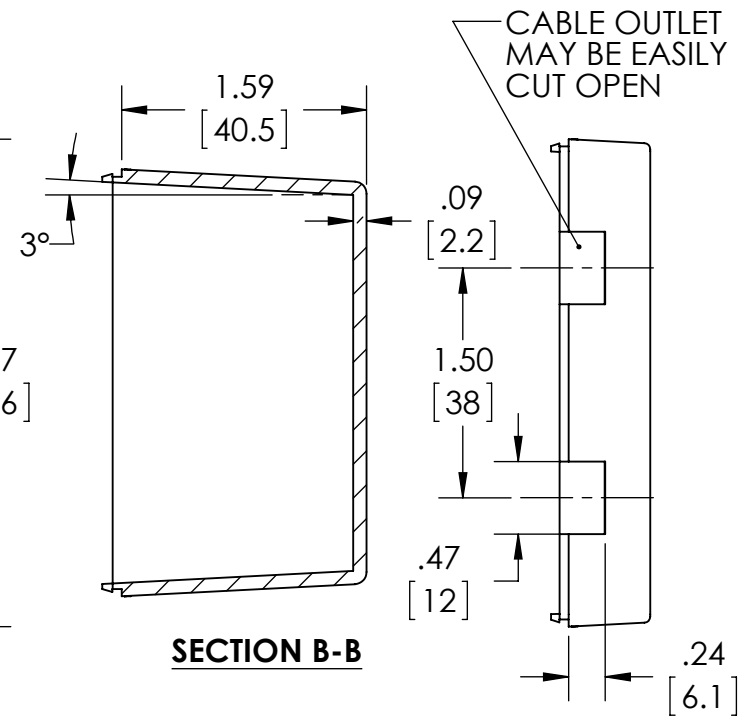
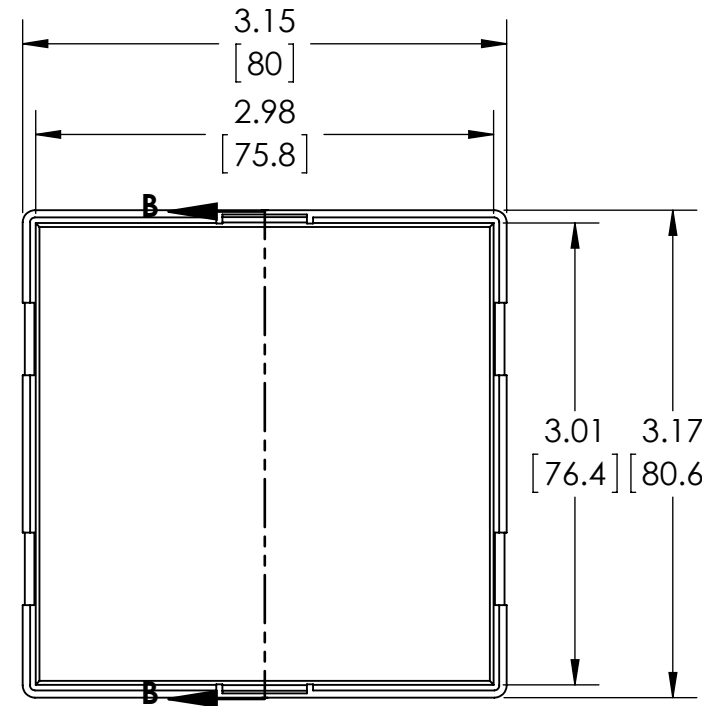

SECTION B-B

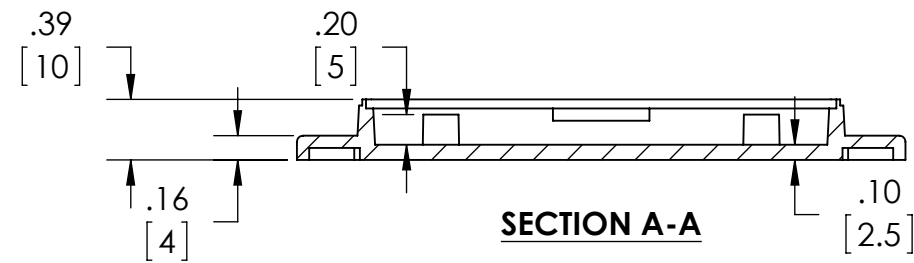

SECTION A-A

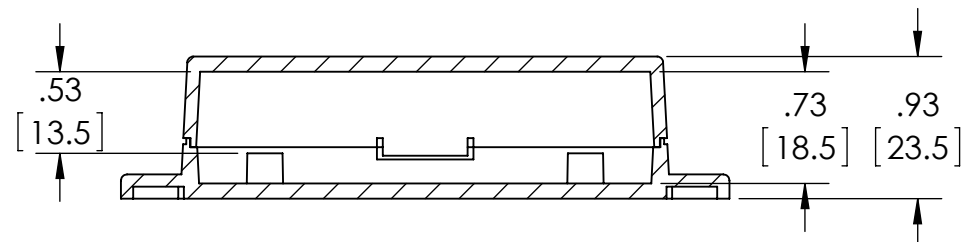

MATERIAL:
ABS UL94-HB

COLOR:
BLACK OR WHITE

DIMENSIONS IN INCH[MM]

DRAWING FOR REFERENCE

