

## Three-Phase Diode Bridge Module 60 Amperes/800 Volts

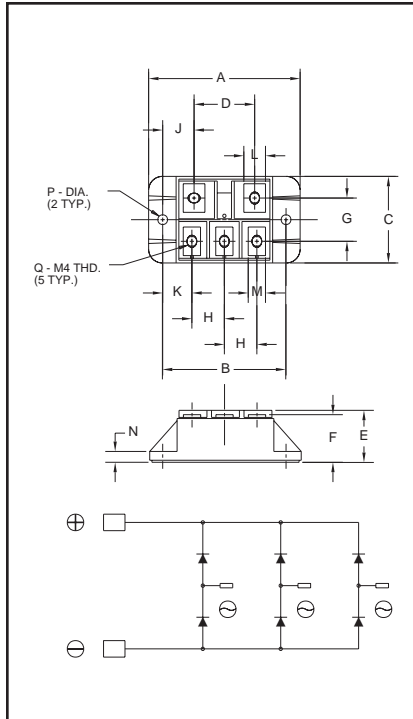

### Outline Drawing

Dimension	Inches	Millimeters
A	2.76	70
B	2.244±0.010	57±0.25
C	1.57	40
D	1.10	28
E	0.94	24
F	0.87	22
G	0.79	20
H	0.59	15
J	0.57	14.5
K	0.53	13.5
L	0.39	10
M	0.31	8
N	0.20	5
P	0.18 Dia.	Dia. 4.5
Q	Metric M4	M4



**MEB00806**  
**Three-Phase Diode Bridge Module**  
60 Amperes/800 Volts

### Description:

Powerex Three-Phase Diode Bridge Modules are designed for use in applications requiring rectification of three-phase AC lines into DC voltage. Each module consists of six diodes and the interconnect required to form a complete three-phase bridge circuit. Each diode is electrically insulated from the mounting baseplate for easy mounting onto a common heatsink with other components.

### Features:

- Isolated Mounting
- Metal Baseplate
- Low Thermal Impedance

### Applications:

- AC and DC Motor Control
- Inverters
- UPS

### Ordering Information:

Select the complete eight digit module part number you desire from the table below.

Example: MEB00806 is an 800 Volt, 60 Ampere Three-Phase Diode Bridge Module.

Type	Voltage Volts (x100)	Current Rating Amperes (x10)
MEB0	08	06



Powerex, Inc., 200 Hillis Street, Youngwood, Pennsylvania 15697-1800 (724) 925-7272

**MEB00806**

**Three-Phase Diode Bridge Module**

60 Amperes/800 Volts

**Absolute Maximum Ratings**

Characteristics	Symbol	MEB00806	Units
Peak Reverse Blocking Voltage	$V_{RRM}$	800	Volts
Transient Peak Reverse Blocking Voltage (Non-Repetitive), $t < 5ms$	$V_{RSM}$	960	Volts
DC Current, $T_j = 105^{\circ}C$	$I_{FM}$	60	Amperes
Peak Half-Cycle Surge (Non-Repetitive) On-State Current (60Hz)	$I_{FSM}$	1000	Amperes
Junction Temperature	$T_j$	-40 to 150	$^{\circ}C$
Storage Temperature	$T_{STG}$	-40 to 125	$^{\circ}C$
Maximum Mounting Torque M4 Mounting Screw	—	12	in.-lb.
Maximum Mounting Torque M4 Terminal Screw	—	12	in.-lb.
Module Weight (Typical)	—	100	Grams
V Isolation	$V_{RMS}$	2000	Volts



Powerex, Inc., 200 Hillis Street, Youngwood, Pennsylvania 15697-1800 (724) 925-7272

**MEB00806**

**Three-Phase Diode Bridge Module**

60 Amperes/800 Volts

**Electrical and Thermal Characteristics,  $T_j = 25^\circ\text{C}$  unless otherwise specified**

Characteristics	Symbol	Test Conditions	MEB00806	Units
<b>Blocking State Maximums</b>				
Reverse Leakage Current, Peak	$I_{RRM}$	$T_j = 150^\circ\text{C}$ , $V_D = 800\text{V}$	10	mA
<b>Conducting State Maximums</b>				
Peak On-State Voltage	$V_{FM}$	$I_{FM} = 100\text{A}$	1.3	Volts
<b>Thermal Maximums</b>				
Thermal Resistance, Junction-to-Case	$R_{\theta(J-C)}$	Per Module	0.31	$^\circ\text{C/Watt}$
Thermal Resistance, Case-to-Sink (Lubricated)	$R_{\theta(C-S)}$	Per Module	0.09	$^\circ\text{C/Watt}$

**MEB00806**

**Three-Phase Diode Bridge Module**

60 Amperes/800 Volts

