

# Low profile BMS Transformers

HM1236/38NL, HM2146/47 and HM2113ZNL

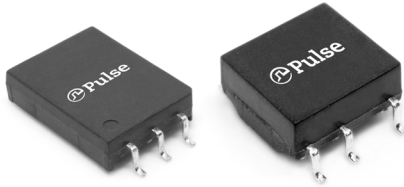

- ④ Fully qualified with leading BMS Silicon ICs
- ④ Designed to meet IEC/UL62368-1
- ④ Low profile height 3.45 or 4.06mm max
- ④ High temperature performance up to 125/150°C
- ④ Ideal for electric vehicles (EV), Energy Storage (ESS) and marine or aviation transportation.

## Operating Temperature - see Table Below

Part Number	Inductance (100kHz, 100mVrms)	Turns Ratio	Choke fitted	Isolation breakdown (Pri:Sec)	Working Voltage	Insulation & Creepage (mm)	Operating Temperature	Qualified BMS Silicon
HM1236NL	500 uH min	1.00 +/- 2%	YES	3200Vrms / 60sec	600VDC	Functional >3mm	-40 to +125°C	MAXIM ; MAX17841B
HM1238NL	300 uH min	1.00 +/- 2%	YES	4300Vrms / 60sec	1000VDC	Functional >5mm	-40 to +150°C	MAXIM ; MAX17841B
HM2113ZNL	150 uH min	1.00 +/- 2%	YES	4300Vrms / 60sec	1000VDC	Functional >5mm	-40 to +125°C	NXP , ADI, Infineon
HM2146NL	150 uH min	1.00 +/- 1%	NO	3000Vrms / 60sec	1000VDC	Functional >3mm	-40 to +125°C	Texas Instr./ NXP, ADI
HM2147NL	500 uH min	1.00 +/- 2%	NO	4300Vrms / 60sec	1500VDC	Functional >3mm	-40 to +125°C	Texas Instr.; BQ7961x-Q1

## Additional Electrical performance

### Electrical (Cont...)

Part Number	Leakage Inductance (Max)	Winding DCR ( $\Omega$ )		Insertion Loss	Return Loss  Z out = 100 Ohm	CMRR	
		PHY Side	Line Side			1 - 10MHz	10- 1000MHz
HM2113ZNL	0.50 uH @ 100kHz	0.45 max	0.85 max	-0.25dB max @ 4MHz	-20dB min @ 4MHz	-35dB	-20dB
HM2146NL	0.50 uH @ 2000kHz	0.50 max	0.50 max	-0.25dB max @ 2MHz	-20dB min @ 2MHz	N/A	N/A
HM2147NL	0.50 uH @ 2000kHz	0.50 max	0.50 max	-0.25dB max @ 2MHz	-20dB min @ 2MHz	N/A	N/A

#### Notes:

1. Storage Temperature: -50°C to +125°C
2. Compliance to J-STD:
  - A. J-STD-002: Solderability at 245oC Reflow Profile
  - B. J-STD-020: Moisture Sensitive Level 1
  - C. J-STD-075: R7, 245oC Maximum Through Reflow Solder
3. The NL suffix part comes in Tubes with 55pcs per tube. To order tape and reel packaging add a 'T' suffix to the part number (ie: HM2146NL becomes H2146NLT). Quantity per reel is 900pcs/reel.
4. Header: DAP (Diallyl Phthalate) with flammability Rating UL 94V-0 or better
5. Lead Frame: Cooper Alloy  
Under plated: Half Hard Ductile Nickel 50-100" (1.3-2.5um)  
Over plated : 100% Tin electro-deposited per ASTM B545 300 - 50u"(8-13um)  
Finish : Matte finish 100% Tin solder
6. AEC-Q200 Qualified, PPAP on request

# Low profile BMS Transformers

HM1236/38NL, HM2146/47 and HM2113ZNL

## MECHANICALS

### HM2113ZNL, HM2146NL, HM2147NL

### HM1236NL, HM1238NL

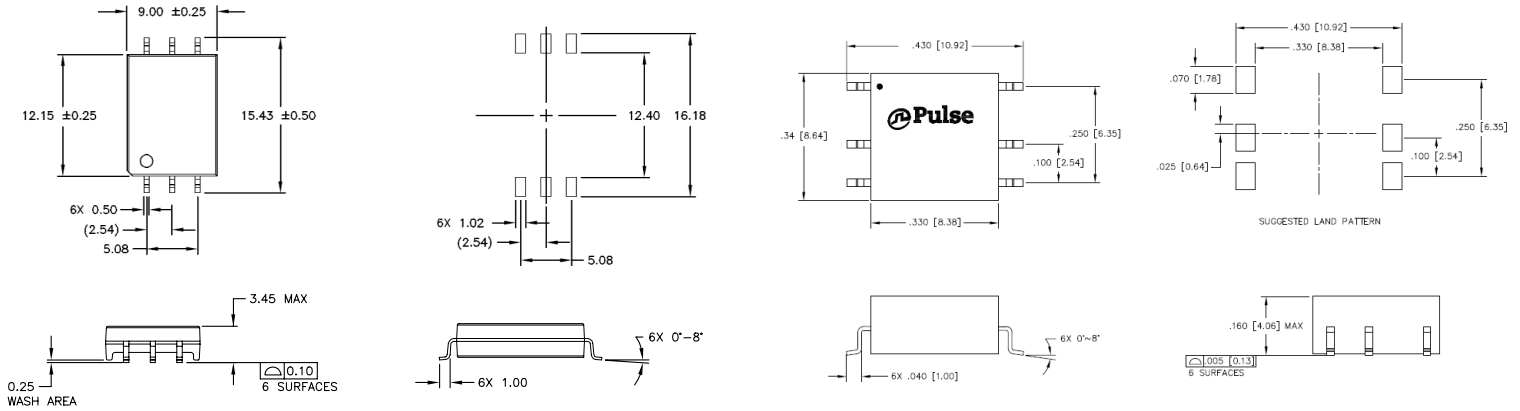

### Dimensions:

Unless otherwise specified,  
all tolerances are  $\pm 0,25$

## SCHEMATICS

### HM21464NL, HM2147NL

### HM2113ZNL

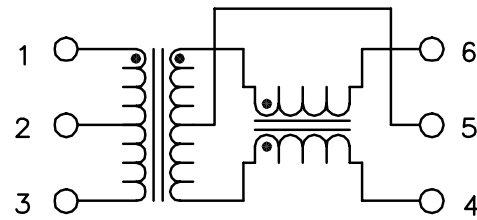
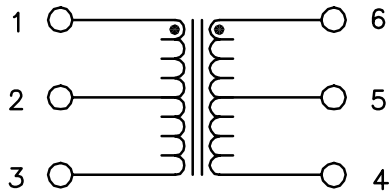

### HM1236NL, HM1238NL

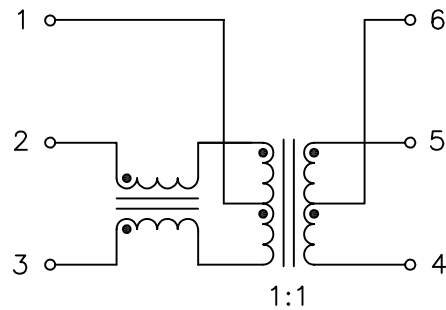

# Low profile BMS Transformers

HM1236/38NL, HM2146/47 and HM2113ZNL

## TAPE & REEL

HM2113ZNL, HM2146NL, HM2147NL

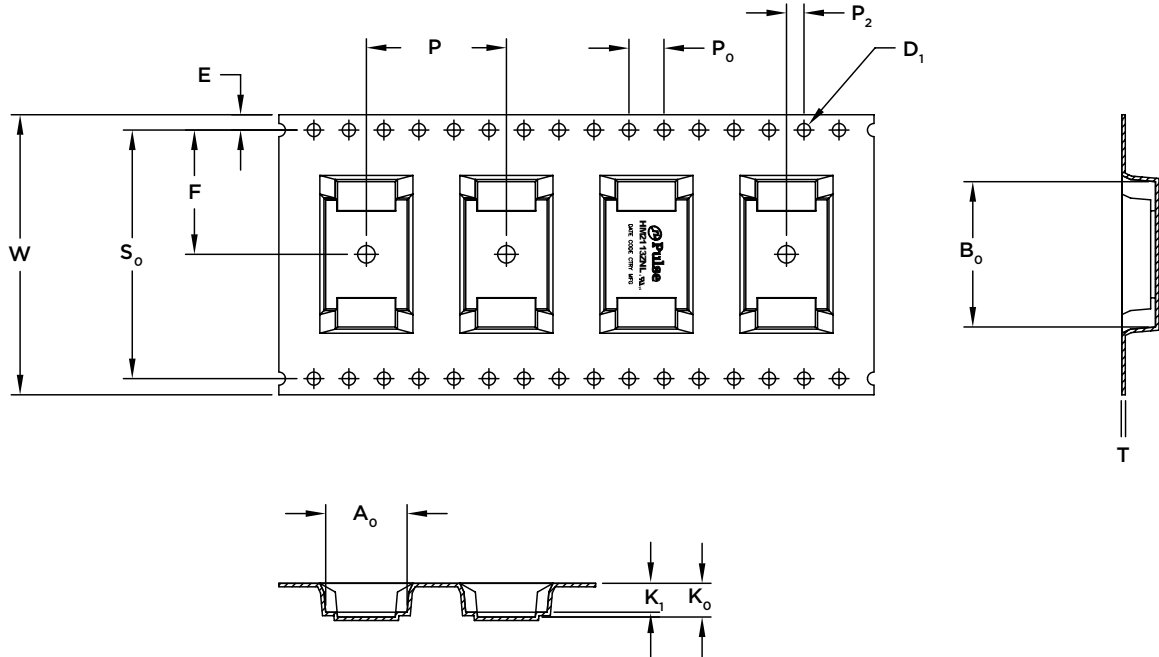

W	32.0±0.30	P	16.00	A <sub>0</sub>	9.30	B <sub>0</sub>	16.60
S <sub>0</sub>	28.40	P <sub>0</sub>	4.00	A <sub>1</sub>	-----	B <sub>1</sub>	-----
E	1.75	P <sub>2</sub>	2.00	A <sub>2</sub>	-----	B <sub>2</sub>	-----
F	14.20	D <sub>0</sub>	-----	K <sub>0</sub>	3.85	K <sub>1</sub>	3.30
T	0.40±0.05	D <sub>1</sub>	1.50 ±0.10 -0.00				UNIT: mm

All Dimensions meet EIA-481-D requirements.

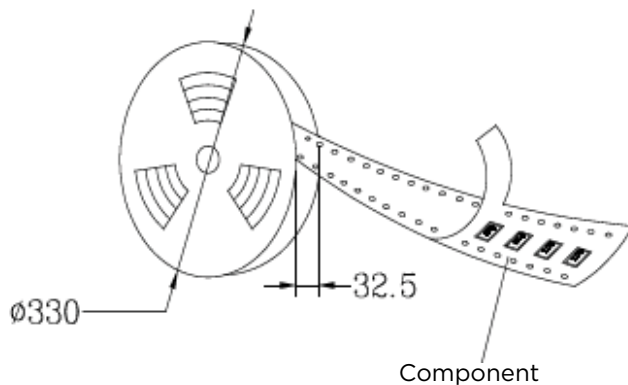

1. **Material:** Black Conductive Polystyrene
2. **Components per Reel:** 1000 pcs
3. **Quantity per box:** 5x reels = 5000 pcs

### For More Information:

Americas - [prodinfo\\_network\\_americas@yageo.com](mailto:prodinfo_network_americas@yageo.com) | Europe - [prodinfo\\_network\\_emea@yageo.com](mailto:prodinfo_network_emea@yageo.com) | Asia - [prodinfo\\_network\\_apac@yageo.com](mailto:prodinfo_network_apac@yageo.com)

Performance warranty of products offered on this data sheet is limited to the parameters specified. Data is subject to change without notice. Other brand and product names mentioned herein may be trademarks or registered trademarks of their respective owners. © Copyright, 2022. Pulse Electronics, Inc. All rights reserved.