



A New Direction in Mixed-Signal

May 2014

XRP7714EVB-DEMO-3

Four Channel Digital PWM Demo Board

Rev. 1.0.0

GENERAL DESCRIPTION

The XRP7714EVB-DEMO-3 demo board is a complete, four channel, power system measuring 2" by 2.5" capable of producing over 35 watts. It is optimized to provide 3.3V, 2.5V 1.8V and 1V at a maximum of 4 amps per channel. The 2.5V, 1.8V and 1V supplies can be adjusted in 50mV increments, and the 3.3V supply is adjustable in 100mV increments. The order and ramp rates for each supply can be programmed to accommodate any sequencing requirement. All power supply operations can be controlled over an I²C interface. Faults, output voltages and currents can also be monitored. Four GPIO signals are available and can be programmed to provide status of power good signals enables and faults. Unused GPIO pins can be programmed as I/O expansion for a microcontroller. The board is supported by PowerArchitect™ and plugs directly onto the Exar Communications Module (XRP77XXEVB-XCM).

EVALUATION BOARD MANUAL

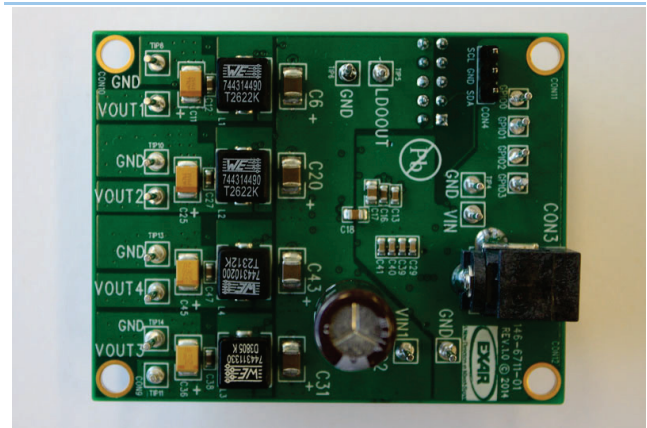

XRP7714EVB-DEMO-3

FEATURES

- **XRP7714 Programmable Controller**
- **4 Channel Power System**
- **Wide Input Voltage Range: 4.5V-25V**
- **Over 35W Capable**
- **Small Form Factor: 2.0" x 2.5"**
- **I²C Interface**
 - Programming
 - Monitoring
 - Control



A New Direction in Mixed-Signal

XRP7714EVB-DEMO-3

Four Channel Digital PWM Demo Board

PIN ASSIGNMENT

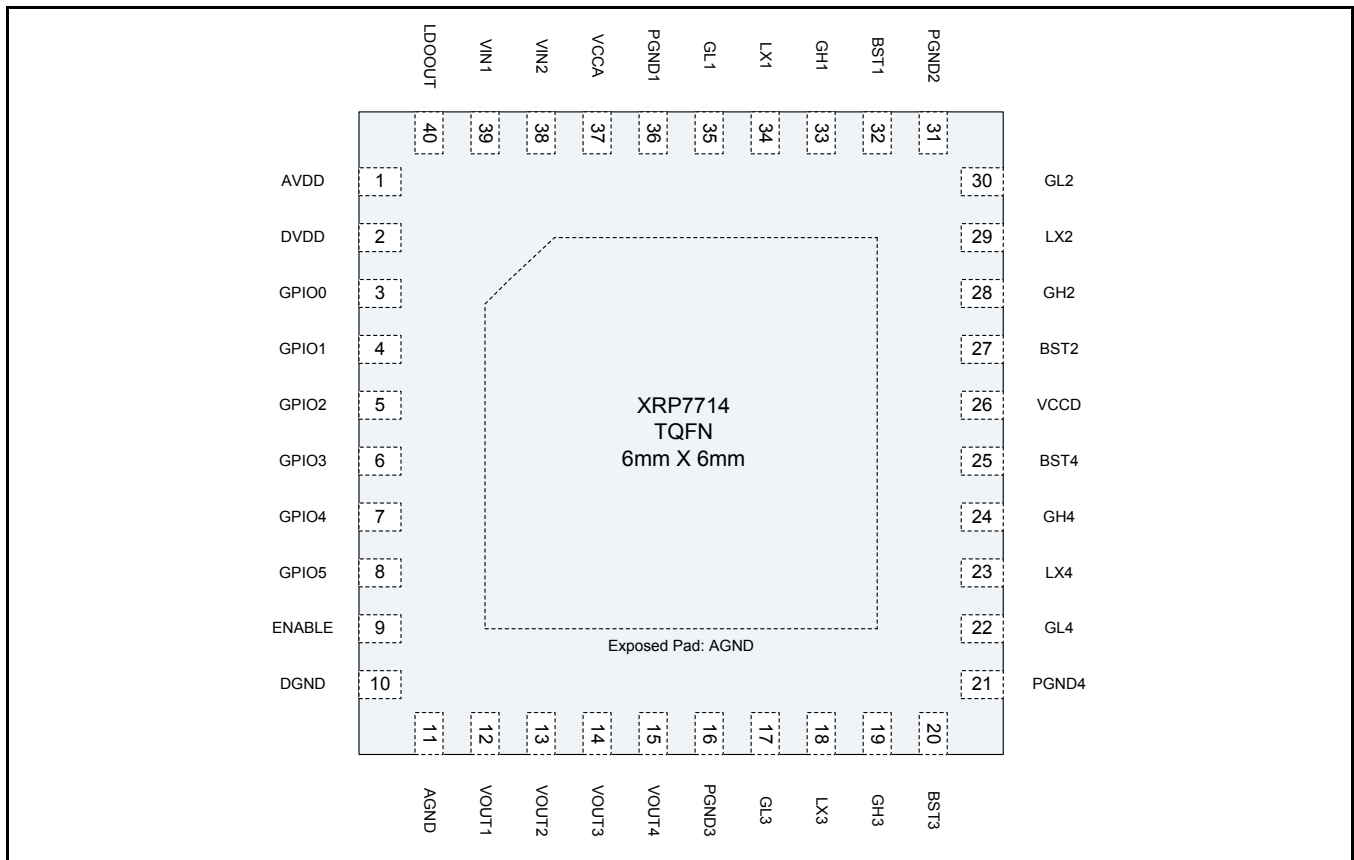

Figure 1: XRP7714 Pin Assignment



A New Direction in Mixed-Signal

XRP7714EVB-DEMO-3

Four Channel Digital PWM Demo Board

PIN DESCRIPTION

Name	Pin Number	Description
VIN1	39	Power source for the internal linear regulators to generate VCCA, VDD and the Standby LDO (LDOOUT). Place a decoupling capacitor close to the controller IC. Also used in UVLO1 fault generation – if VIN1 falls below the user programmed limit, all channels are shut down. The VIN1 pin needs to be tied to VIN2 on the board with a short trace.
VIN2	38	If the Vin2 pin voltage falls below the user programmed UVLO VIN2 level all channels are shut down. The VIN2 pin needs to be tied to VIN1 on the board with a short trace.
VCCA	37	Output of the internal 5V LDO. This voltage is internally used to power analog blocks. Note that a compensation capacitor should be used on this pin (see application note).
VCCD	26	Gate Drive input voltage. This is not an output voltage. This pin can be connected to VCCA to provide power for the Gate Drive. VCCD should be connected to VCCA with the shortest possible trace and decouple with a minimum 1µF capacitor. Alternatively, VCCD could be connected to an external supply (not greater than 5V).
PGND1→4	36,31,16,21	Ground connection for the low side gate driver. Should be routed as the return line of the GL signal. Connect at low side FET source.
AVDD	1	Output of the internal 1.8V LDO. A decoupling capacitor should be placed between AVDD and AGND close to the chip (with short traces).
DVDD	2	Input for powering the internal digital logic. This pin should be connected to AVDD.
DGND	10	Digital Ground. Connect this pin to the ground plane at the exposed pad with a separate trace.
AGND	11	Analog Ground. Connect this pin to the ground plane at the exposed pad with a separate trace
GL1-GL4	35,30,17,22	Output pin of the low side gate driver. Connect directly to the respective gate of an external N-channel MOSFET.
GH1-GH4	33,28,19,24	Output pin of the high side gate driver. Connect directly to the respective gate of an external N-channel MOSFET.
LX1-LX4	34,29,18,23	Lower supply rail for the high-side gate driver (GHx). Connect this pin to the switching node at the junction between the two external power MOSFETs and the inductor. These pins are also used to measure voltage drop across bottom MOSFETs in order to provide output current information to the control engine.
BST1-BST4	32,27,20,25	High side driver supply pin(s). Connect BST to an external boost diode and a capacitor as shown in the front page diagram. The high side driver is connected between the BST pin and LX pin.
GPIO0-GPIO3	3,4,5,6	These pins can be configured as inputs or outputs to implement custom flags, power good signals and enable/disable controls. A GPIO pin can also be programmed as an input clock synchronizing IC to external clock. Refer to the "GPIO Pins" Section and the "External Clock Synchronization" Section for more information.
GPIO4_SDA, GPIO5_SCL	7,8	I2C serial interface communication pins. These pins can be re-programmed to perform GPIO functions in applications when I2C bus is not used.
VOUT1→4	12,13,14,15	Voltage sense. Connect to the output of the corresponding power stage.
LDOOUT	40	Output of the Standby LDO. It can be configured as a 5V or 3.3V output. A compensation capacitor should be used on this pin [see Application Note].
ENABLE	9	If ENABLE is pulled high, the chip powers up (logic reset, registers configuration loaded, etc.). If pulled low for longer than 100us, the XRP7714 is placed into shutdown.
AGND	Exposed Pad	Analog Ground. Connect to analog ground (as noted above for pin 11).

ORDERING INFORMATION

Part Number	Description
XRP7714EVB-DEMO-3	XRP7714EVB-DEMO-3 Evaluation Board
XRP7714EVB-DEMO-3-KIT	Evaluation kit includes XRP7714EVB-DEMO-3 Evaluation Board with Power Architect software and controller board



A New Direction in Mixed-Signal

XRP7714EVB-DEMO-3

Four Channel Digital PWM Demo Board

USING THE EVALUATION BOARD

INPUT VOLTAGE CONFIGURATION

The XRP7714EVB-DEMO-3 demo board has several different input voltage options. The Input voltage components are rated at 35V. The power components have been optimized for a 12V input rail. When running the board at an input voltage other than 12V, use PowerArchitect™ to evaluate the system performance.

Single Wide Range, Input Voltage Rail

The XRP7714EVB-DEMO-3 ship from the factory configured for a single wide range input. The Input voltage range is from 5.5V to 25V.

Single 5V Voltage Rail

Installing a zero ohm resistor into position R28 connects VIN to VCCA. This allows operation down to 4.75V, but restricts the maximum input voltage to 5.5V.

Dual Voltage Rail Operation

The XRP7714EVB-DEMO-3 demo board can be configured to operate from two separate rails.

The following modifications must be made:

- Remove 0 ohm resistors R2 and R13
- Connect power for the XRP7714 between pins VIN and GND
- Connect channel power between pins VIN1 and GND

I²C INTERFACE

The XRP77XX family of controllers employs a standard I²C interface. Pull-ups for the I²C signals are not included on the demo board. If using the demo board with something other than the XRP77xxEVB-XCM, verify that the SDA and SCL lines are pulled up.

Channel Design and Limitations

Channel 1 is designed to provide an output voltage from 3.3V to 5.0V. The default voltage is 3.3V.

Channel 2 is designed to provide an output voltage from 1.8V to 2.5V. The default voltage is 2.5V.

Channel 3 is designed to provide an output voltage from 1.5V to 1.8V. The default voltage is 1.8V.

Channel 4 is designed to provide an output voltage from .9 to 1.2V. The default voltage is 1.0V. The Tantalum output capacitor is has a 2.5V rating. If modifying the channel 4 design, do not exceed four volts unless the C45 is replaced.

ENABLE PIN

The ENABLE pin connects to an RC network This delays turn on of the device. It is pulled up to VCCA with a 100K resistor and to ground through a .01uF capacitor. It appears on pin 9 of connector CON5. This pin can be used to turn on or turn off the device.

Bring up Procedure

Plug the PowerXR evaluation board on to the XCM as shown below.

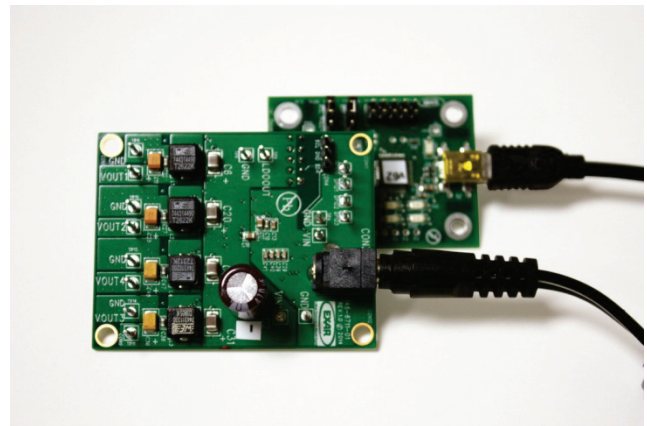

Insert the USB cable into the computer and the XCM board.

Load the PowerArchitect™ software.

Select the XRP7714EVB configuration and select "Create Configuration".



A New Direction in Mixed-Signal

XRP7714EVB-DEMO-3

Four Channel Digital PWM Demo Board

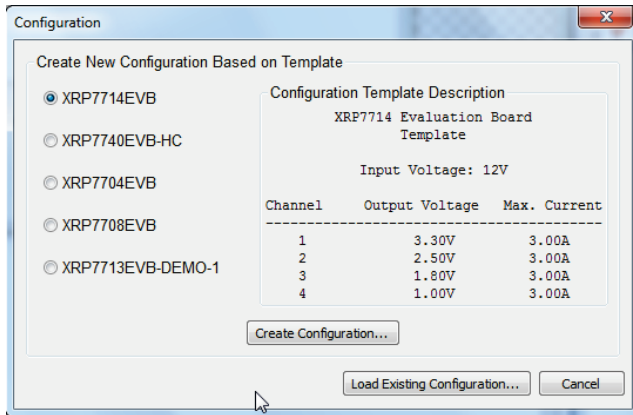

You will be prompted for a filename by a Create New File Dialog box. Navigate to a location to save the configuration, enter a filename and select Save.

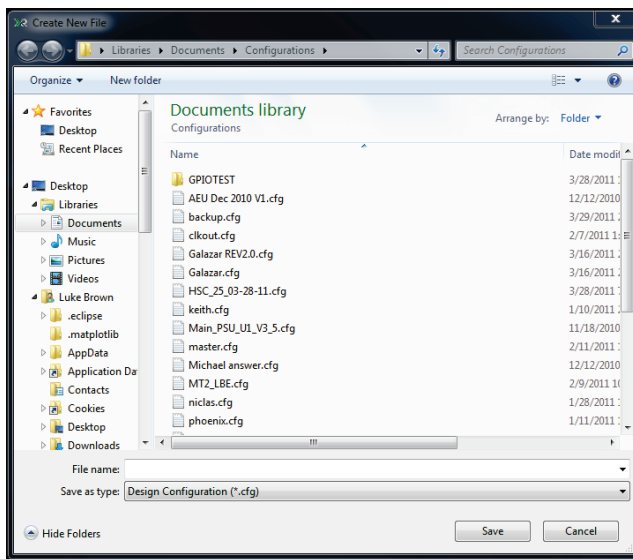

If the XCM board is recognized, there will be an "XCM" tab. If not, "Ctrl-b" should initiate a board search and find it.

On the "DEMO" tab, the lower left should indicate a board connected, but the rest of the page should be greyed out.

Apply Power to the board: Please refer to the appropriate board connection diagram for your specific evaluation board. If using a single supply, Connect the input supply between the VIN pin and the GND pin. If using a dual supply, Connect the chip power between VIN pin and GND, and connect Power Vin between the VIN1 pin and GND. If using the 5V only option with R28 populated, no power connections are necessary.

Turn on the Power supply. The "DEMO" page should now become live indicating communication with the XRP7714. Click "Program Chip" and a window should pop up indicating "Success". Now click on the box at the middle right "Enable All".

Refer to the Exar PowerArchitect™ Quick Start Guide for information on how to run the software.

EVALUATION BOARD CONNECTIONS

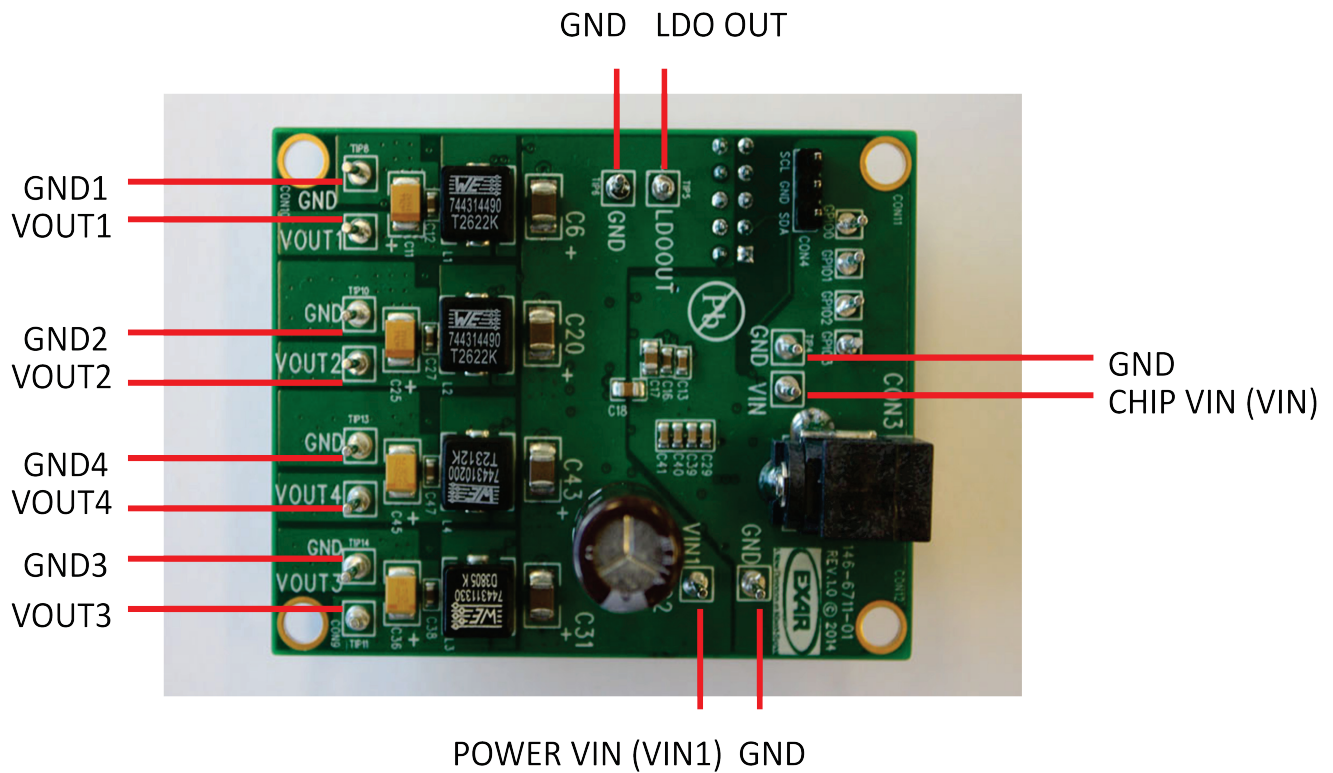
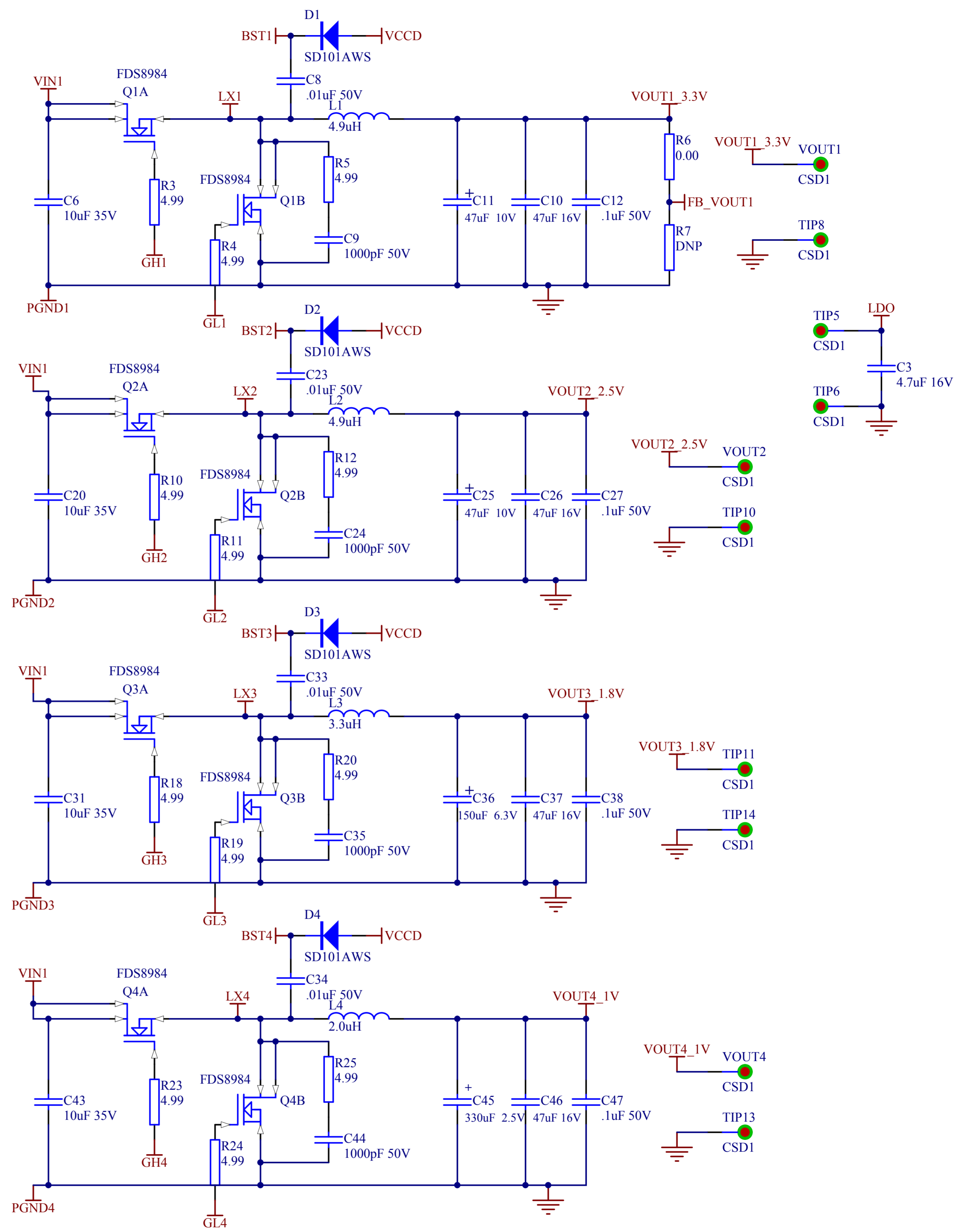
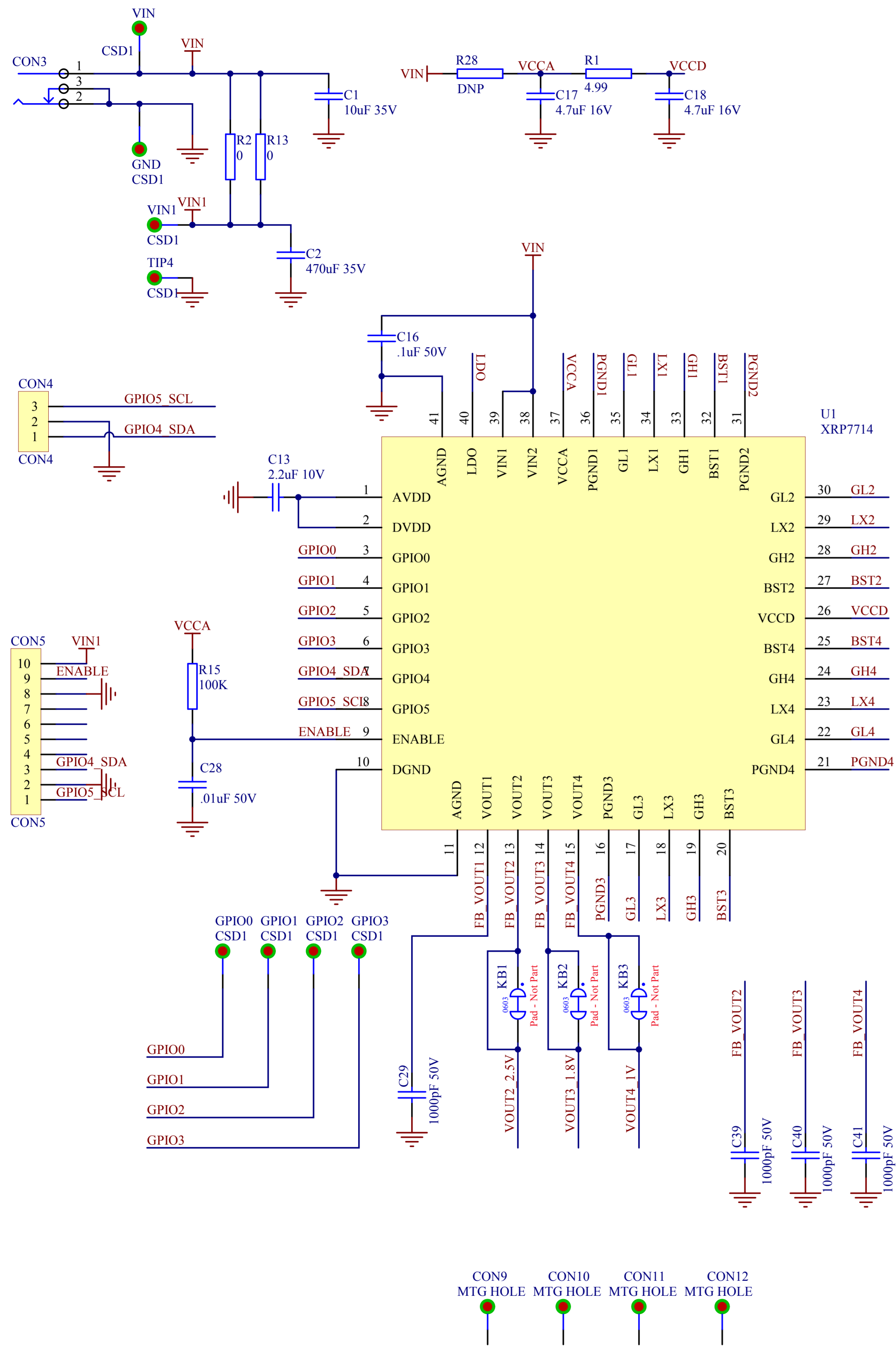

Figure 2: XRP7714EVB-DEMO-3 Board Connections



Title			XRP7714EV B-DEMO-3
Size	Number	Revision	
B		1.0	
Date:	3/24/2014	Sheet 1 of 1	
File:	C:\SVN_LOCAL\XRP7714.Sch	Drawn By:	



A New Direction in Mixed-Signal

XRP7714EVB-DEMO-3

Four Channel Digital PWM Demo Board

BILL OF MATERIAL

Ref.	Qty	Part Number	Manufacturer	Size	Description
U1	1	XRP7714ILB-F	EXAR CORP	QFN40	4 Ch. 25V PWM Step Down Controller QFN40
Q1,Q2,Q3,Q4	4	FDS8984	FAIRCHILD	8-SOIC	30mohm MOSFET N-CH DUAL 30V 6A 8-SOIC
D1,D2,D3,D4	4	SD101AWS	Diodes Inc.	SOD-323	Diode Schottky, 40V, 400mW, SOD-323
L1,L2	2	744314490	WURTH ELEKTRONIK	7.0x6.9mm	Inductor 4.9uH, 14.5mΩ, 6.5A
L3	1	744311330	WURTH ELEKTRONIK	7.0x6.9mm	Inductor 3.3uH, 9.0mΩ, 9.0A
L4	1	744310200	WURTH ELEKTRONIK	7.0x6.9mm	Inductor 2.0uH, 5.85mΩ, 11.5A
C1,C6,C20,C31,C43	5	GRM32ER7Y106KA12L	MURATA CORP.	1210	Cap Cer 10uF, 35V, X7R, 10% 1210
C2	1	EKZE350ELL471MJ20S	United Semi-Con	Radial, Can	Cap Aluminium 470uF, 35V, 20%, 23mOhm
C3,C17,C18	3	GRM21BR71C475KA73L	MURATA CORP.	0805	Cap Cer 4.7uF, 16V, X7R, 0805
C8,C23,C28,C33,C34	5	GRM188R71H103KA01D	MURATA CORP.	0603	Cap Cer 0.01uF, 50V,X7R,0603
C9,C24,C29,C35,C39,C40,C41,C44	8	GRM188R71H102KA01D	MURATA CORP.	0603	Cap Cer 1000pF,50V,X7R,0603
C10,C26,C37,C46	4	GRM32ER61C476ME15L	MURATA CORP.	1210	CAP CER 47uF, 16V, 20%, X5R, 1210
C11,C25	2	TCJB476M010R0070	AVX CORP.	1210	Cap Tant 47uF, 10V, 20%, 1210
C12,C16,C27,C38,C47	5	GRM188R71H104KA93D	MURATA CORP.	0603	Cap Cer 0.1uF, 50V,X7R, 0603
C13	1	GRM188R71A225KE15D	MURATA CORP.	0603	Cap Cer. 2.2uF, 10V, X7R
C36	1	T520B157M006ATE070	KEMET	1411	Cap Tant 150uF, 6.3V, 20%, 1411
C45	1	T520B337M2R5ATE045	KEMET	1411	Cap Tant 330uF, 2.5V, 20%, 1411
R1,R3,R4,R10,R11,R18,R19,R23,R24	9	CRCW06034R99FKEA	Vishay/Dale	0603	Res 4.99 Ohm, 1%, 1/10W, 0603
R2,R13	2	CRCW12060000Z0EA	Vishay/Dale	1206	Res 0.0 Ohm, 1/4W, 1206
R5,R12,R20,R25	4	CRCW08054R99FKEA	Vishay/Dale	0805	Res 4.99 Ohm, 1%, 1/8W, 0805
R6	1	CRCW0603000Z0EA	Vishay/Dale	0603	Res 0.0 Ohm, 1/10W, 0603
R15	1	CRCW0603100KFKEA	Vishay/Dale	0603	Res 100K Ohm, 1%, 1/0W, 0603
CON3	1	RAPC722X	Switchcraft Inc.	2.1mmID, 5.5mmOD	Conn PoweJack Mini R/A
CON4	1	61304011121	WURTH ELEKTRONIK	2.54mm, 3 PIN	2.54mm pin header
CON5	1	61301021821	WURTH ELEKTRONIK	2.54mm, 10 pins	2.54mm Dual Socket Header
GPO0,GPO1,GPO2, GPO3, GND,TIP4,TIP5,TIP6, TIP8,TIP10,TIP11, TIP13,TIP14,VIN,VIN1, VOUT1,VOUT2,VOUT4	18	K30/C	Vector Electronics	0.042"	Inboard Pin 0.042"



A New Direction in Mixed-Signal

XRP7714EVB-DEMO-3

Four Channel Digital PWM Demo Board

EVALUATION BOARD LAYOUT

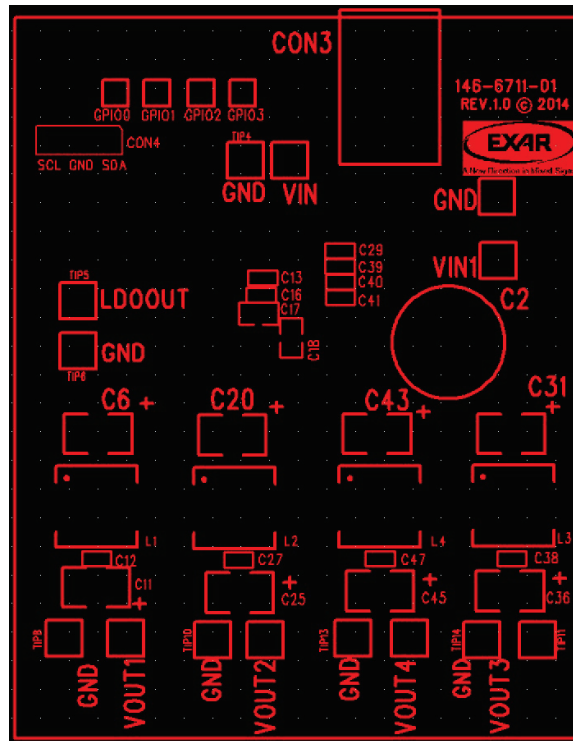

Figure 3: Component Placement Top Side

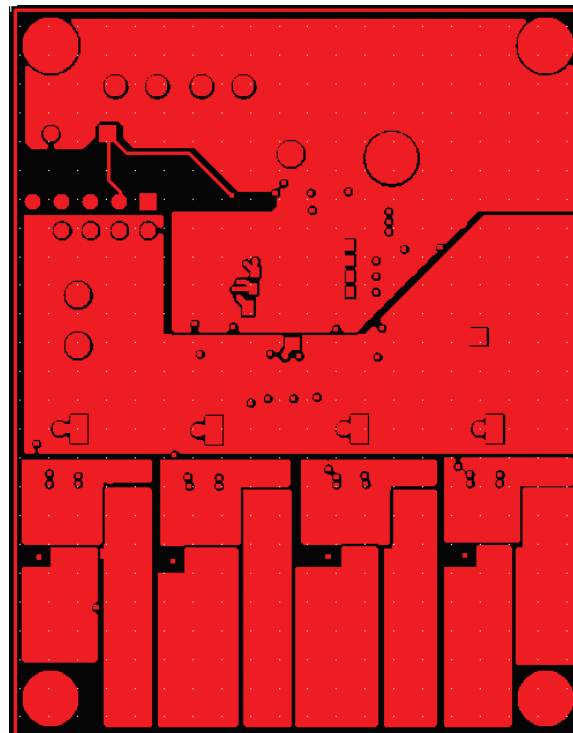

Figure 4: Top Layer

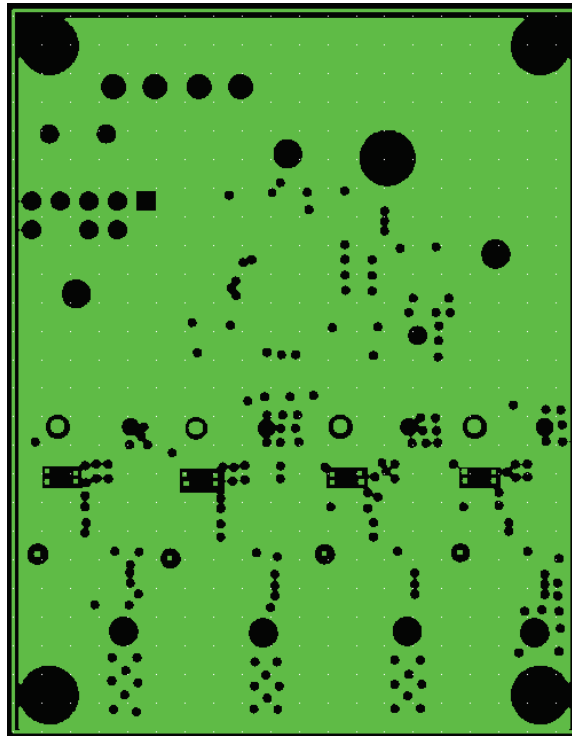

Figure 5: Ground Plane

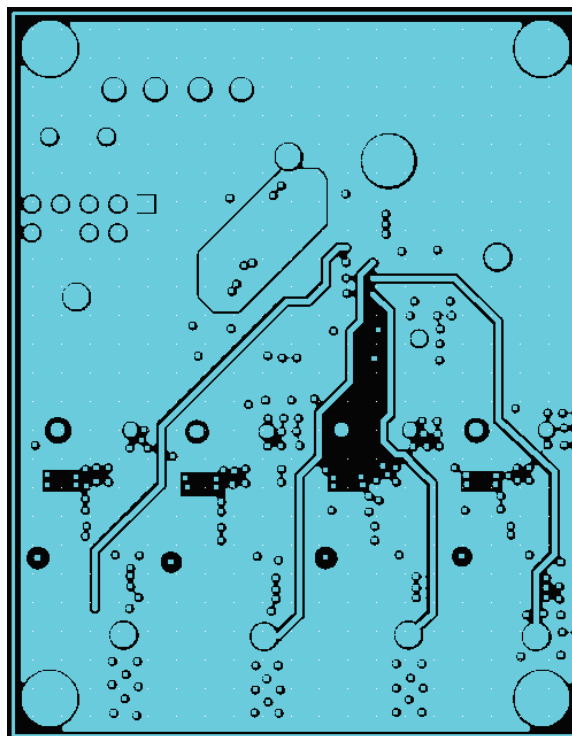

Figure 6: Mid-Layer

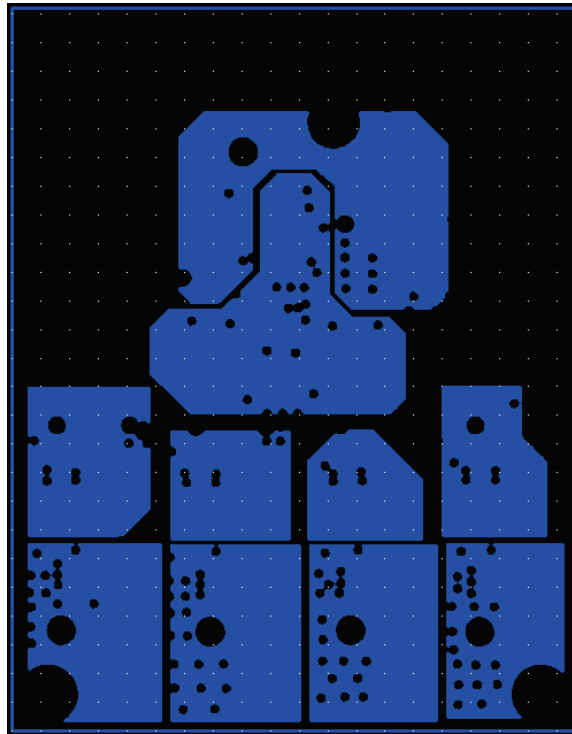

Figure 7: Mid-Layer 2

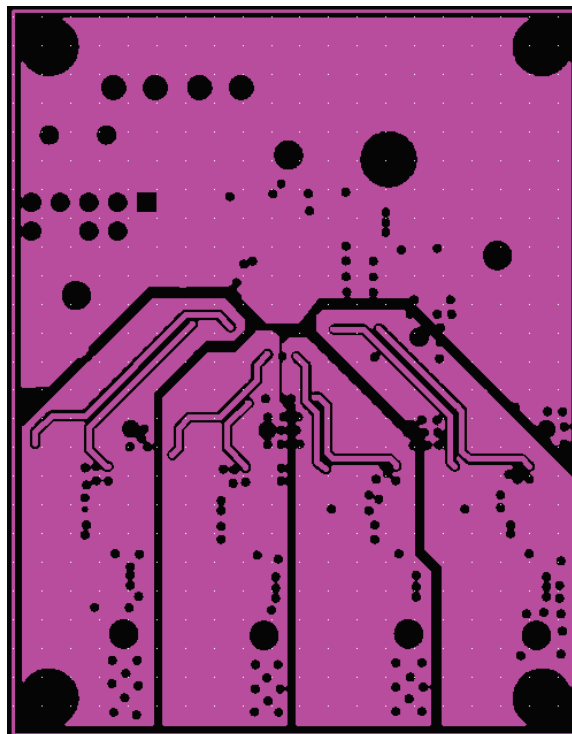

Figure 8: Mid-Layer 3



A New Direction in Mixed-Signal

XRP7714EVB-DEMO-3

Four Channel Digital PWM Demo Board

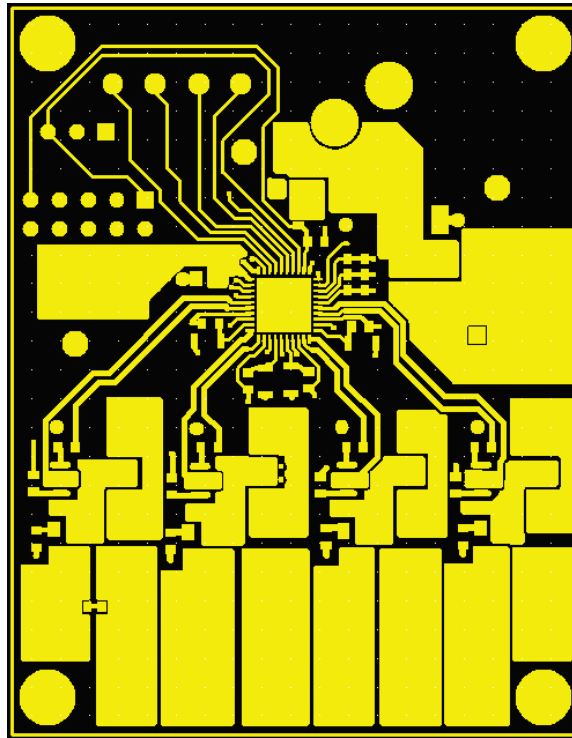

Figure 9: Bottom Layer

EVALUATION BOARD EFFICIENCY PERFORMANCE

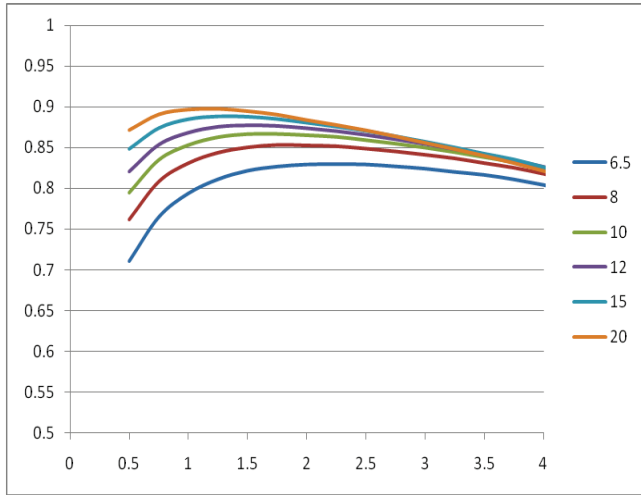

Figure 10: All Channels Efficiency

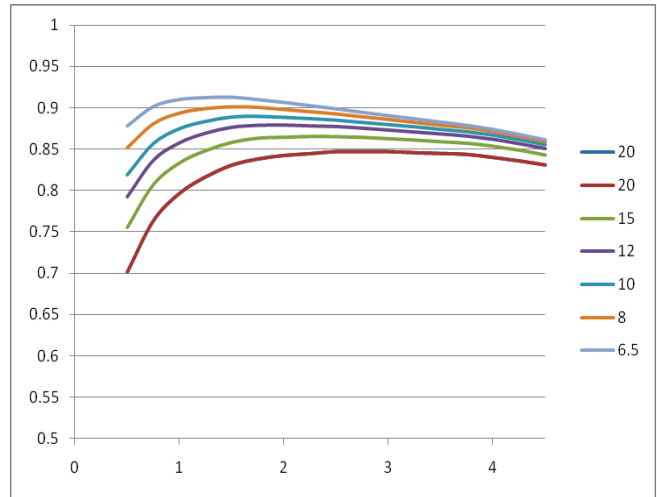

Figure 11: 3.3V Efficiency

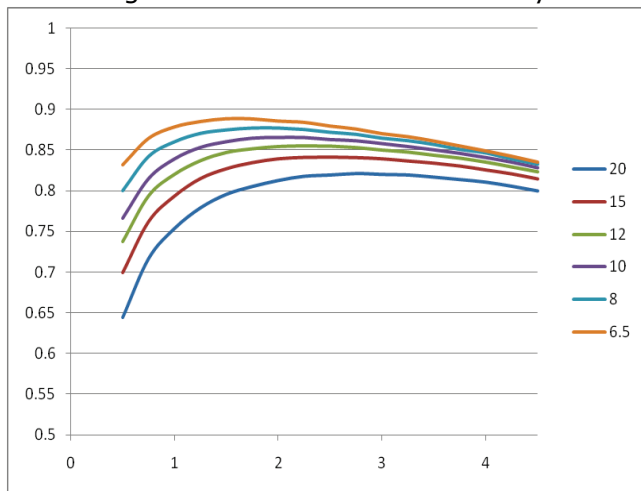

Figure 12: 2.5V Efficiency

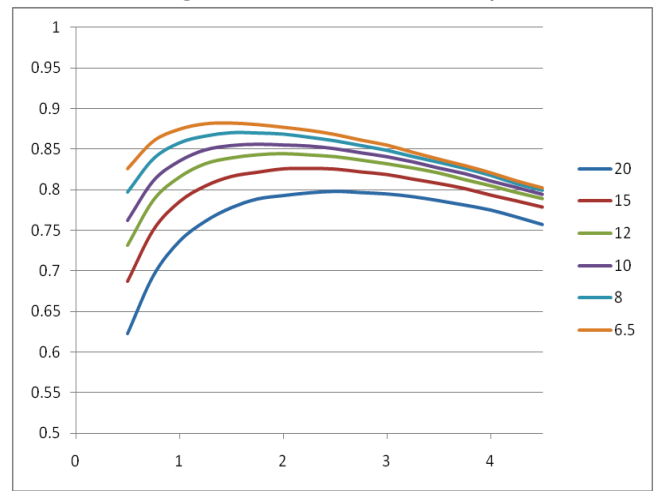

Figure 13: 1.8V Efficiency

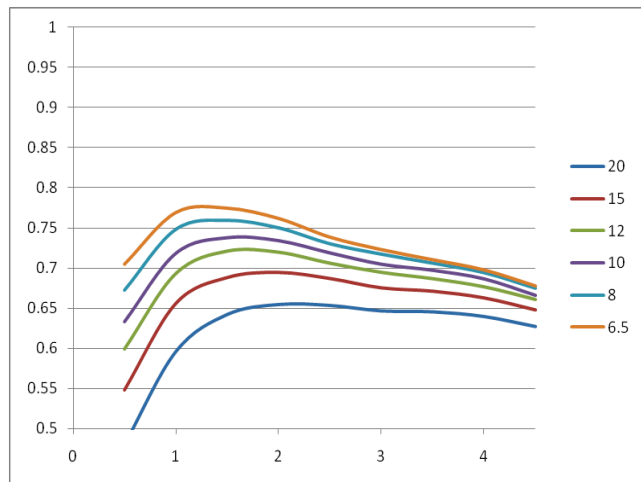

Figure 14: 1V Efficiency



A New Direction in Mixed-Signal

EVALUATION BOARD LINE LOAD REGULATION PERFORMANCE

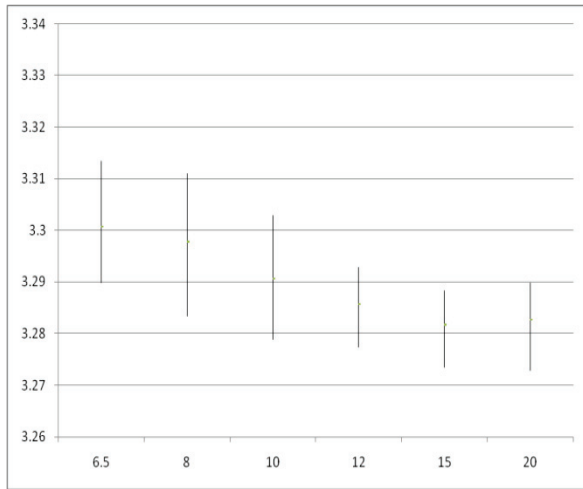

Figure 15: Line Load Regulation 3.3V

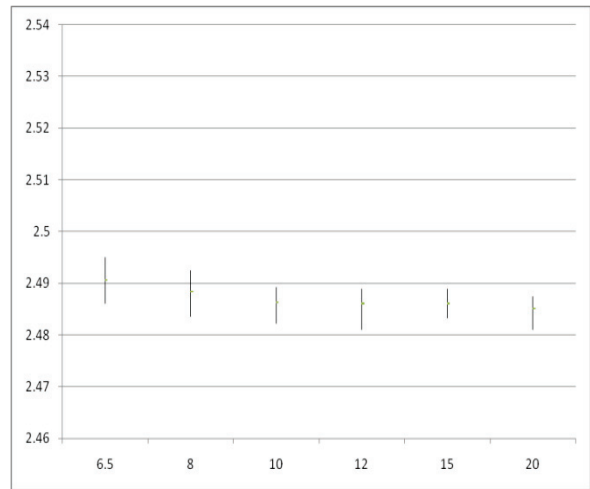

Figure 16: Line Load Regulation 2.5V

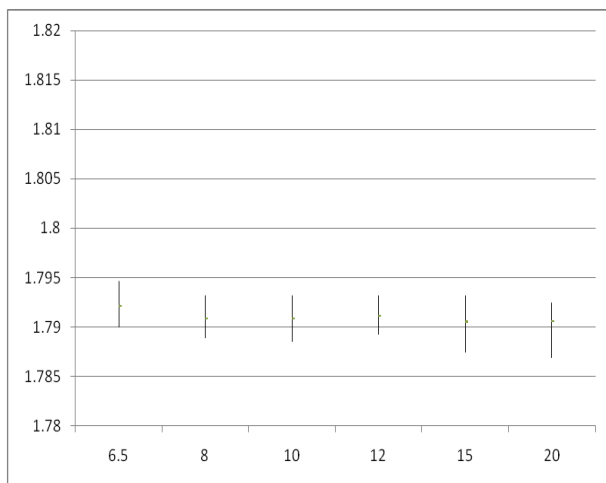

Figure 17: Line Load Regulation 1.8V

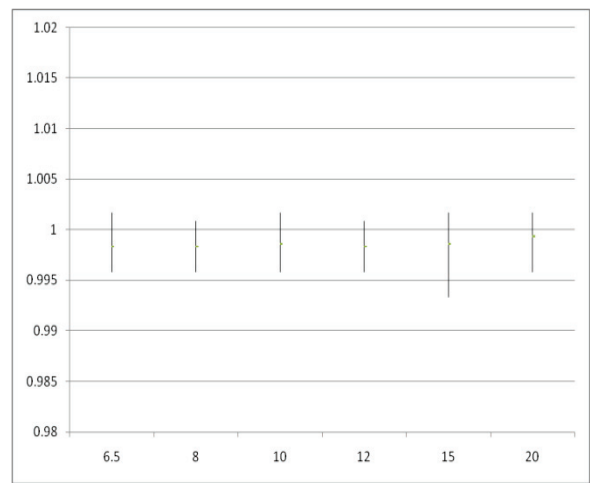

Figure 18: Line Load Regulation 1.0V



A New Direction in Mixed-Signal

XRP7714EVB-DEMO-3

Four Channel Digital PWM Demo Board

DOCUMENT REVISION HISTORY

Revision	Date	Description
1.0.0	05/05/2014	Initial release of document

BOARD REVISION HISTORY

Board Revision	Date	Description
REV1.0	05/05/2014	Initial release of XRP7714EVB-DEMO-3 evaluation board

FOR FURTHER ASSISTANCE

Email:

powertechsupport@exar.com

customersupport@exar.com

Exar Technical Documentation:

<http://www.exar.com/TechDoc/default.aspx?>



A New Direction in Mixed-Signal

EXAR CORPORATION

HEADQUARTERS AND SALES OFFICES

48720 Kato Road

Fremont, CA 94538 - USA

Tel.: +1 (510) 668-7000

Fax: +1 (510) 668-7030

www.exar.com

NOTICE

EXAR Corporation reserves the right to make changes to the products contained in this publication in order to improve design, performance or reliability. EXAR Corporation assumes no responsibility for the use of any circuits described herein, conveys no license under any patent or other right, and makes no representation that the circuits are free of patent infringement. Charts and schedules contained here in are only for illustration purposes and may vary depending upon a user's specific application. While the information in this publication has been carefully checked; no responsibility, however, is assumed for inaccuracies.

EXAR Corporation does not recommend the use of any of its products in life support applications where the failure or malfunction of the product can reasonably be expected to cause failure of the life support system or to significantly affect its safety or effectiveness. Products are not authorized for use in such applications unless EXAR Corporation receives, in writing, assurances to its satisfaction that: (a) the risk of injury or damage has been minimized; (b) the user assumes all such risks; (c) potential liability of EXAR Corporation is adequately protected under the circumstances.

Reproduction, in part or whole, without the prior written consent of EXAR Corporation is prohibited.