



PART NAME

SNAP UTILITY BOX

PART No.

CU-18427-B CU-18427-W

REVISION DATE

10-7-14

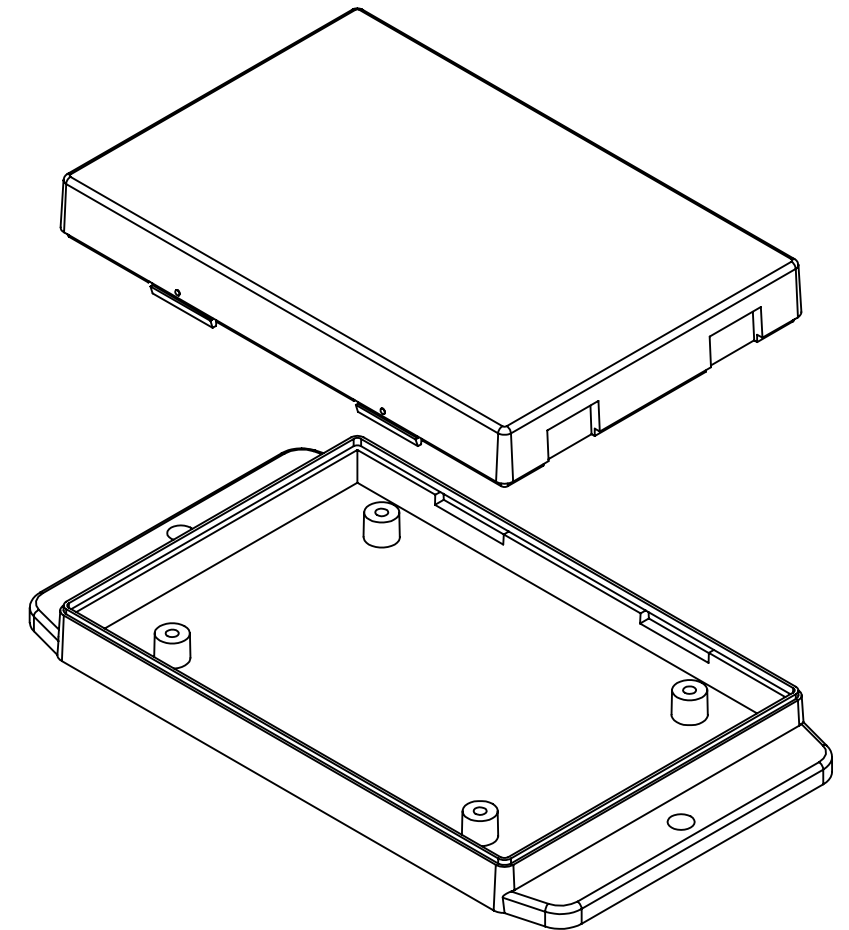
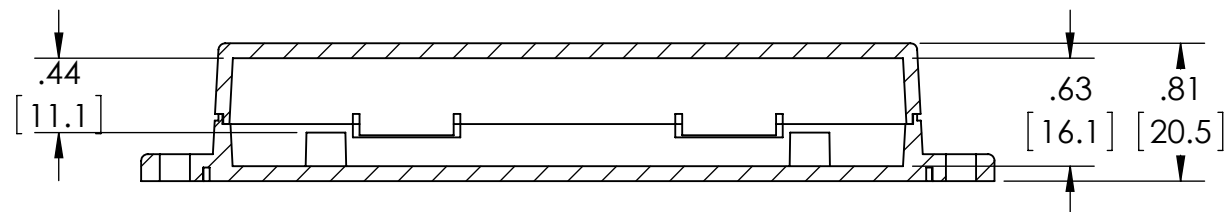
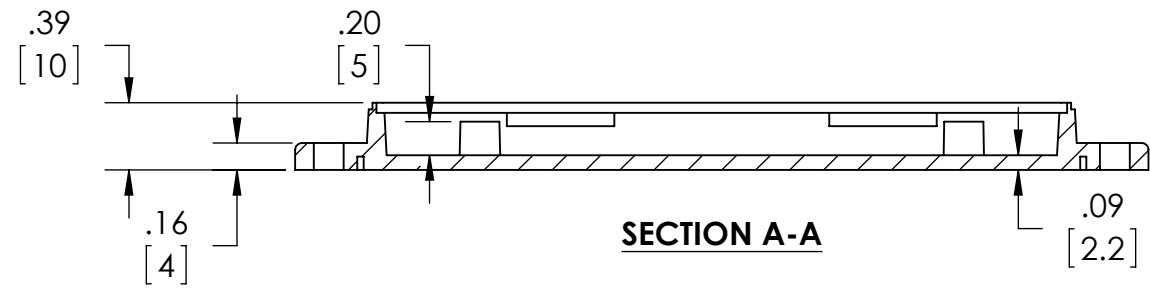
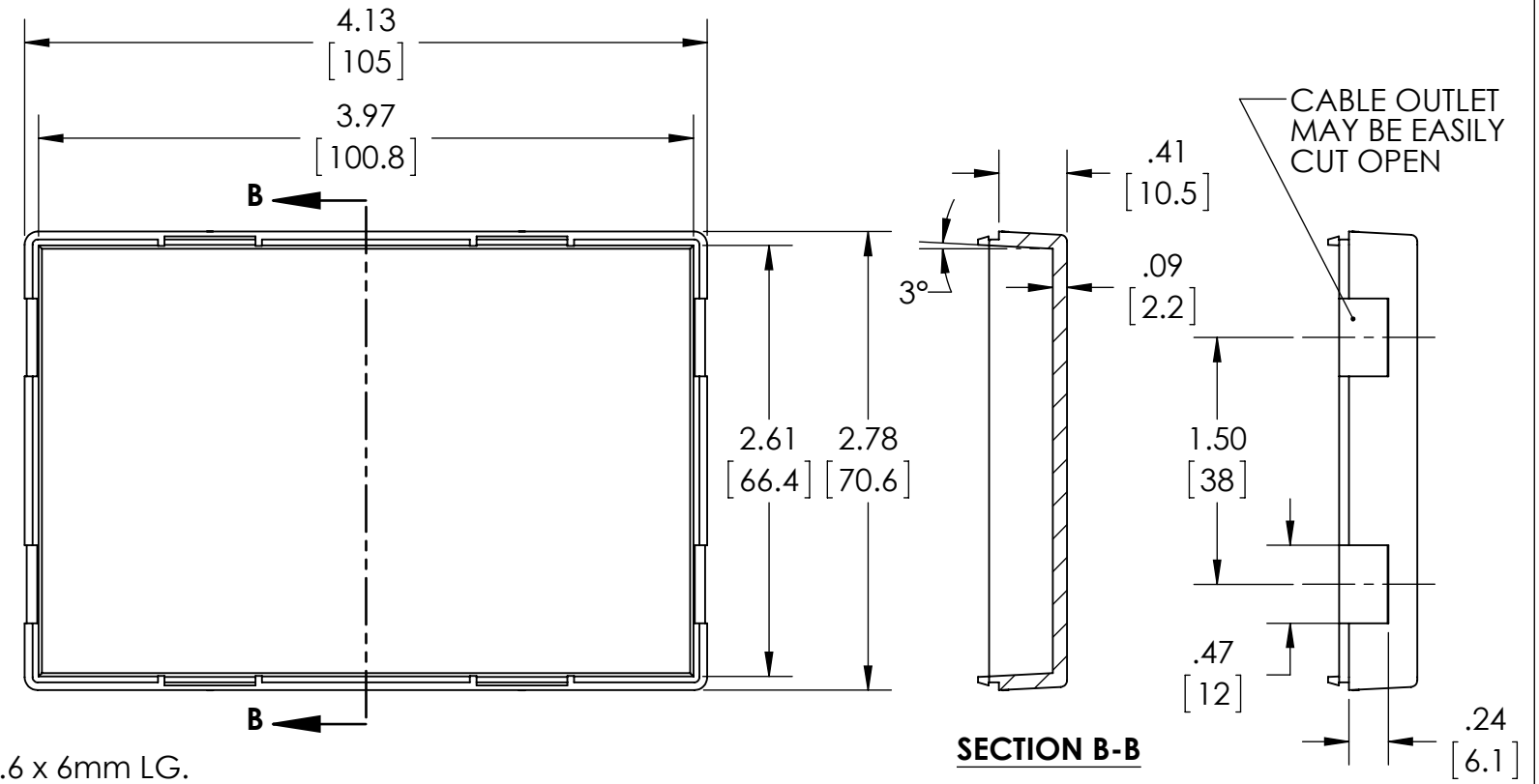
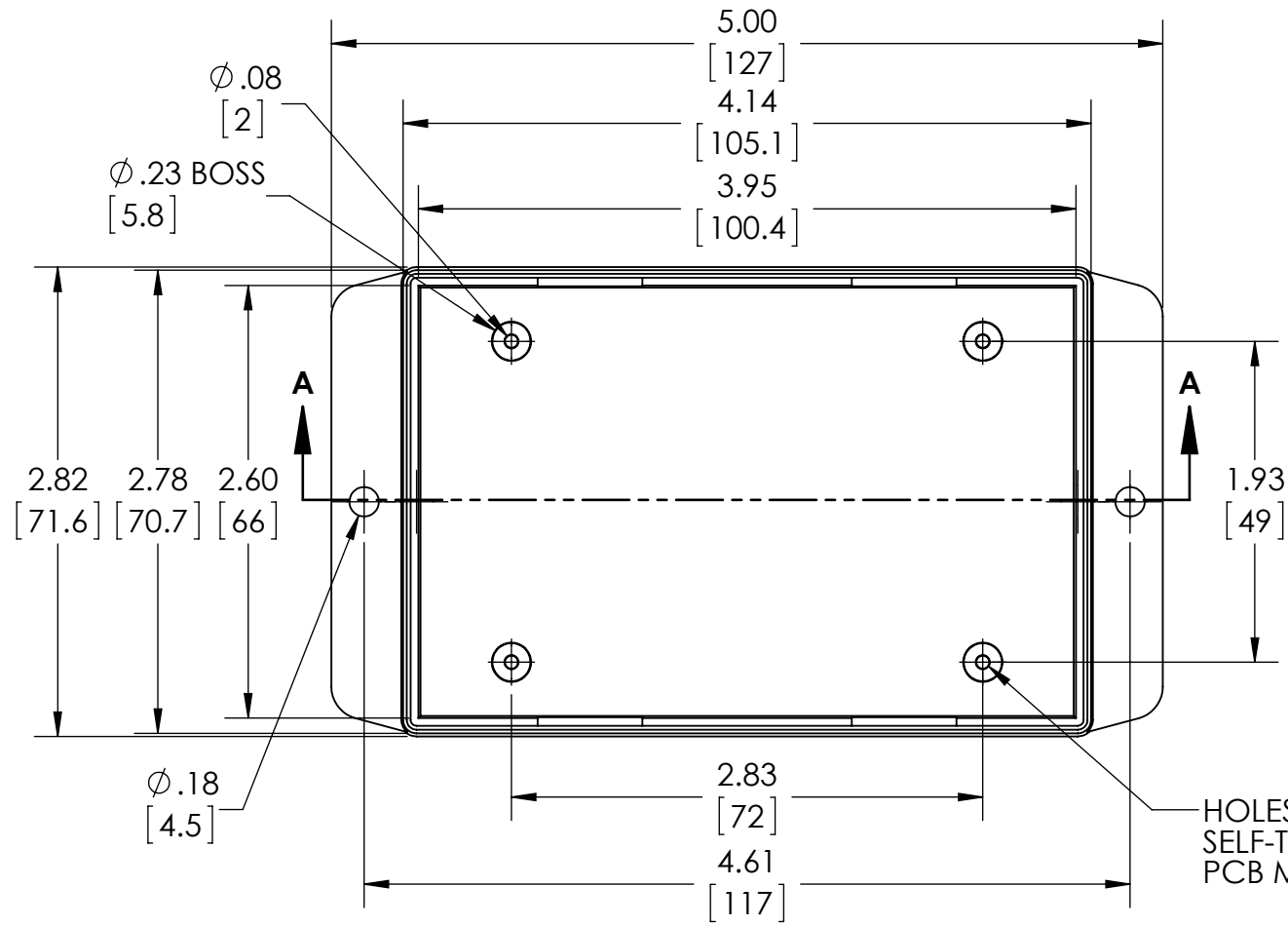

MATERIAL:
ABS UL94-HB

COLOR:
BLACK OR WHITE

DIMENSIONS IN INCH[MM]
DRAWING FOR REFERENCE