

DIMENSIONS OF ALL SIZES AVAILABLE				
SIZE	A	B	C	D
14 POS.	43.90	36.00	25.20	17.70
24 POS.	54.70	46.80	36.00	28.20
36 POS.	67.75	59.74	48.90	41.10
50 POS.	83.10	74.85	64.10	56.70

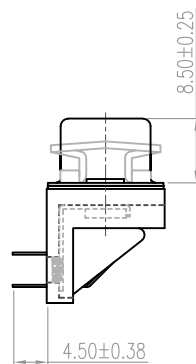
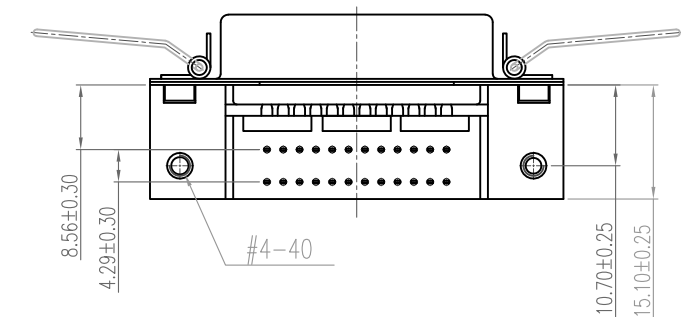
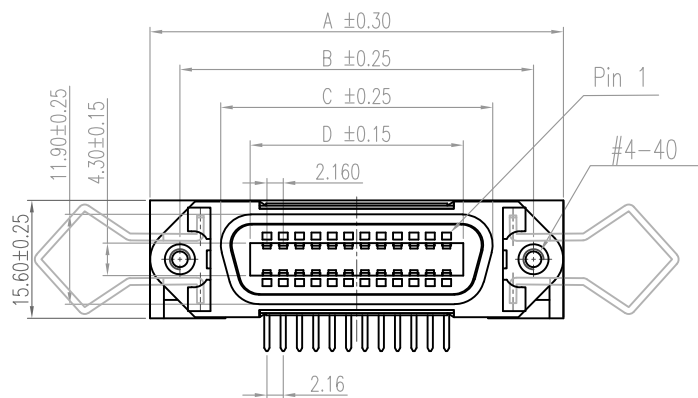

ELECTRICAL CHARACTERISTICS

VOLTAGE: 250 VAC (RMS) Max.
 CURRENT RATING: 1 AMP PER CONTACT
 CONTACT RESISTANCE: 30 mΩ Max.
 INSULATION RESISTANCE: 1000 MΩ Min.
 DIELECTRIC WITHSTANDING: 1000 VAC (RMS)
 TOTAL MATING FORCE: 25 LBS Max.
 TOTAL UNMATING FORCE: 2 LBS Min.
 OPERATING TEMPERATURE: -55°C TO +105°C

MATERIAL CHARACTERISTICS

INSULATOR: PA9T, UL94V-0, BLUE
 CONTACTS: COPPER ALLOY
 CONTACT PLATING: GOLD FLASH MATING AREA
 MATTE TIN ON PCB CONTACTS
 CONTACT INSERTION FORCE: 25 LBS MAX.
 CONTACT SEPARATION FORCE: 2 LBS. MIN.

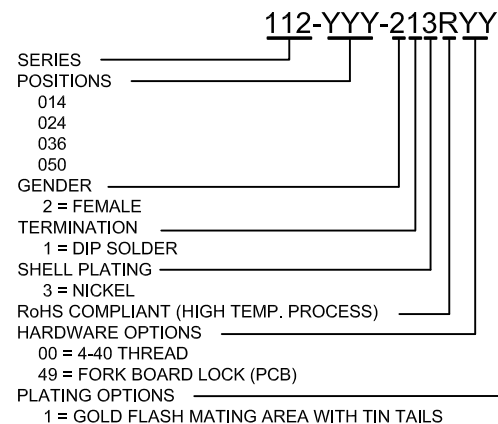

RoHS COMPLIANT

UNITS = MM

DO NOT SCALE FROM DRAWING



THESE DRAWINGS AND SPECIFICATIONS ARE THE PROPERTY OF NorComp AND SHALL NOT BE REPRODUCED, COPIED OR USED AS THE BASIS FOR THE MANUFACTURE OR SALE OF APPARATUS WITHOUT WRITTEN PERMISSION.

DRAWN:
J. KADEL
DATE:
12/26/2018

NorComp

SCALE: NTS	SHEET 1	OF 3	REV 0
DWG NO.		112-YYY-213RYY1	

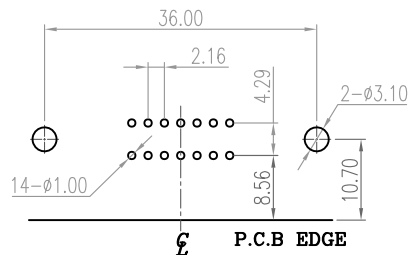

RECOMMENDED P.C.B LAYOUT 14 POS.

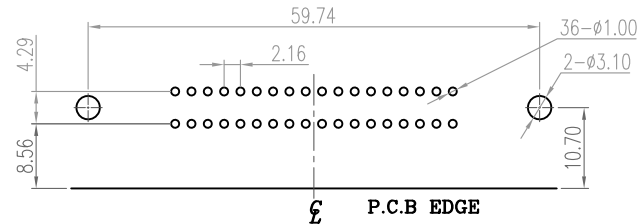

RECOMMENDED P.C.B LAYOUT 36 POS.

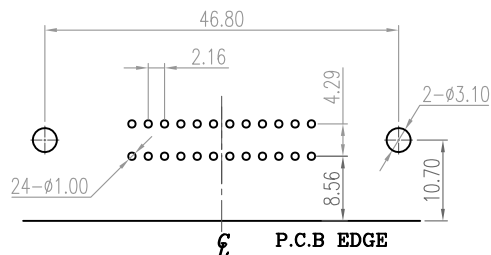

RECOMMENDED P.C.B LAYOUT 26 POS.

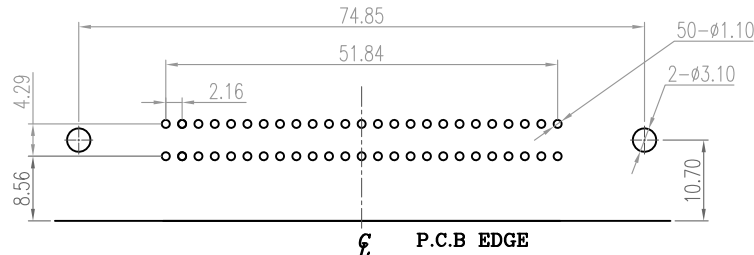

RECOMMENDED P.C.B LAYOUT 50 POS.

-49x HARDWARE OPTION

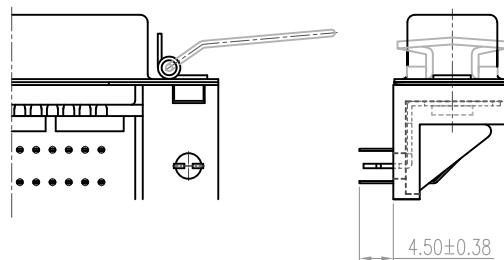

RoHS COMPLIANT

UNITS = MM

DO NOT SCALE FROM DRAWING



THESE DRAWINGS AND SPECIFICATIONS ARE THE PROPERTY OF NorComp AND SHALL NOT BE REPRODUCED, COPIED OR USED AS THE BASIS FOR THE MANUFACTURE OR SALE OF APPARATUS WITHOUT WRITTEN PERMISSION.

DRAWN:

J. KADEL

DATE:

12/26/2018

NorComp

SCALE:
NTS

SHEET OF
2 3

REV
0

DWG NO.

112-YYY-213RYY1

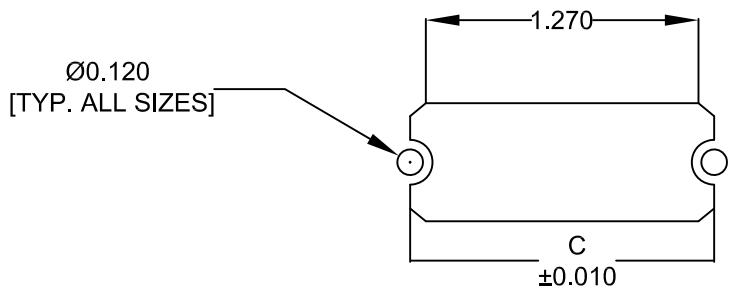

14 POSITION

	014	024	036	050
C	1.417	1.843	2.352	2.947
	36.00	46.80	59.74	74.85

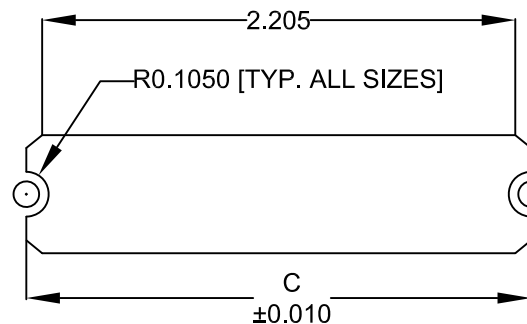

36 POSITION

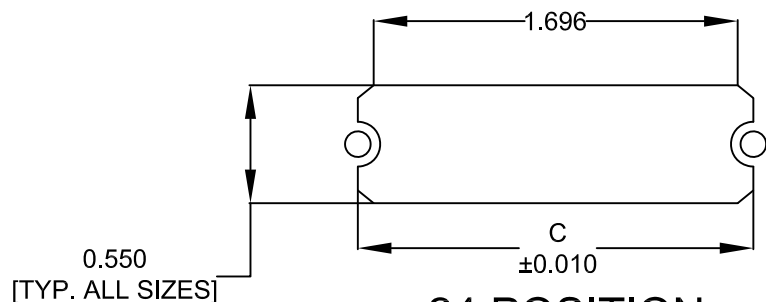

24 POSITION

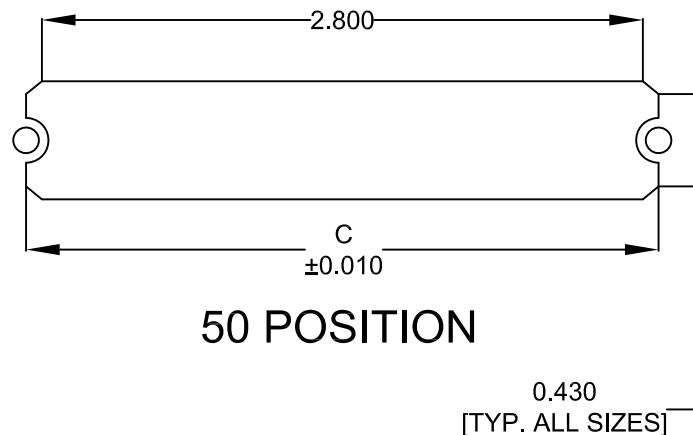

50 POSITION

NOTE DIMENSION "C" =
 CENTER TO CENTER OF MOUNTING HOLES
 CENTER OF RADI
 OVERALL LENGTH OF CUTOUT

RoHS COMPLIANT

UNITS = INCHES [MM] DO NOT SCALE FROM DRAWING



THESE DRAWINGS AND SPECIFICATIONS ARE THE PROPERTY OF NorComp AND SHALL NOT BE REPRODUCED, COPIED OR USED AS THE BASIS FOR THE MANUFACTURE OR SALE OF APPARATUS WITHOUT WRITTEN PERMISSION.

DRAWN:
 J. KADEL
 DATE:
 12/26/2018

NorComp

SCALE: NTS	SHEET 3	OF 3	REV 0
DWG NO.		112-YYY-213RYY1	