

ADNB 60W Series

Up to 60 Watts
Din Rail

Total Power: Up to 60 Watts
Input Voltage: 88 to 264 Vac
124 to 370 Vdc
of Outputs: Single

Special Features

- Universal AC input 88-264Vac
- Installed on DIN rail TS35/7.5 or 15
- Brown-out Protection
- Protections: Short Circuit/Over load/Over voltage
- All using 105degC long life electrolytic capacitors
- High operation temperature up to 70°C
- Withstand 2G vibration test
- High efficiency, long life and high reliability
- 3 Years Warranty

Safety*

UL /cUL 508
TUV EN60950-1
UL1310 class 2
LPS Pass



Product Descriptions

The ADNB 60W series features a universal 88-264Vac input – enabling it to be used anywhere in the world – and is also capable of operating from a 124-370Vdc Input. The ADNB 60W series offers a power rating up to 60W with convection cooling, and it provides precisely regulated output voltages of 12V, 15V, 24V and 48Vdc.

The ADNB 60W series power supply is comprehensively protected against over voltage, over load and short-circuit conditions.

Note* - Cover AC input only

Model Numbers

Model	Output Voltage	Minimum Load	Maximum Load	Efficiency ¹
ADNB050-12-1PM-C	12Vdc	0A	5.0A	86%
ADNB040-15-1PM-C	15Vdc	0A	4.0A	87%
ADNB025-24-1PM-C	24Vdc	0A	2.5A	87%
ADNB012-48-1PM-C	48Vdc	0A	1.25A	88%

Note 1 - Typical value at nominal input voltage(230Vac) and maximum load.

Options

None

Electrical Specifications

Absolute Maximum Ratings

Stress in excess of those listed in the “Absolute Maximum Ratings” may cause permanent damage to the power supply. These are stress ratings only and functional operation of the unit is not implied at these or any other conditions above those given in the operational sections of this TRN. Exposure to any absolute maximum rated condition for extended periods may adversely affect the power supply’s reliability.

Table 1. Absolute Maximum Ratings:

Parameter	Model	Symbol	Min	Typ	Max	Unit
Input Voltage AC continuous operation DC continuous operation	All models	$V_{IN,AC}$	88	-	264	Vac
	All models	$V_{IN,DC}$	124	-	370	Vdc
Maximum Output Power Convection continuous operation	All models	$P_{O,max}$	-	-	60	W
Isolation Voltage Input to Output Input to Safety Ground Output to Earth Ground	All models		-	-	4242	Vdc
	All models		-	-	2121	Vdc
	All models		-	-	500	Vdc
Ambient Operating Temperature	All models	T_A	-20	-	+70 ¹	°C
Storage Temperature	All models	T_{STG}	-40	-	+85	°C
Humidity (non-condensing) Operating Non-operating	All models		20	-	90	%
	All models		10	-	95	%
MTBF	All models		-	360 ²	-	Khours

Note 1 - Derate each output at 2.5% per degree C from 50 °C to 70 °C.

Note 2 - Note 2 - Certified MIL-HDBK-217F, tested at 25degC,230Vac.

Input Specifications

Table 2. Input Specifications:

Parameter	Conditions	Symbol	Min	Typ	Max	Unit
Operating Input Voltage, AC ¹	All	$V_{IN,AC}$	88	115/230	264	Vac
Operating Input Voltage, DC	All	$V_{IN,DC}$	124	-	370	Vdc
Input AC Frequency	All	f_{IN}	47	50/60	63	Hz
Input Current	$V_{IN,AC} = 115Vac$ $V_{IN,AC} = 230Vac$	$I_{IN,max}$	- -	1.3 0.6	- -	A A
No Load Input Power ($V_O = ON, I_O = 0A$)	$V_{IN,AC} = 115/230Vac$	$P_{IN,no-load}$	-	-	5	W
Harmonic Line Currents	All	THD	EN61000-3-2/EN61000-3-3			
Startup Surge Current (Inrush) @ 25°C	$V_{IN,AC} = 230Vac$	$I_{IN,surge}$	-	60	-	A_{PK}
Efficiency ($T_A = 25°C$, free air convection cooling)	ADNB050-12-1PM-C	$V_{IN,AC} = 230Vac$ $I_O = I_{O,max}$	-	86	-	%
	ADNB040-15-1PM-C		-	87	-	%
	ADNB025-24-1PM-C		-	87	-	%
	ADNB012-48-1PM-C		-	88	-	%
Hold Up Time	$V_{IN,AC} = 115Vac$ $P_O = P_{O,max}$	$t_{Hold-Up}$	16	-	-	mSec
	$V_{IN,AC} = 230Vac$ $P_O = P_{O,max}$	$t_{Hold-Up}$	32	-	-	mSec
Turn On Delay	$V_{IN,AC} = 115Vac$ $P_O = P_{O,max}$	$t_{Turn-On}$	-	-	800	mSec
	$V_{IN,AC} = 230Vac$ $P_O = P_{O,max}$	$t_{Turn-On}$	-	-	800	mSec
Leakage Current to safety ground	$V_{IN} = 240Vac$ $f_{IN} = 50/60Hz$	$I_{IN,leakage}$	-	-	1000	μA

Output Specifications

Table 3. Output Specifications:

Parameter	Conditions	Symbol	Min	Typ	Max	Unit
Factory Set Point Accuracy	All	V_O	-1.0	-	+1.0	%
Output Voltage	ADNB050-12-1PM-C ADNB040-15-1PM-C ADNB025-24-1PM-C ADNB012-48-1PM-C	V_O	-	12.0 15.0 24.0 48.0	-	Vdc Vdc Vdc Vdc
Output Adjust Range	ADNB050-12-1PM-C ADNB040-15-1PM-C ADNB025-24-1PM-C ADNB012-48-1PM-C	V_O	10.8 13.5 21.6 43.2	-	13.2 16.5 26.4 52.8	Vdc Vdc Vdc Vdc
Output Ripple, pk-pk	ADNB050-12-1PM-C ADNB040-15-1PM-C ADNB025-24-1PM-C ADNB012-48-1PM-C	V_O	-	-	100 100 120 180	mV _{PK-PK}
Convection Output Current, continuous	ADNB050-12-1PM-C ADNB040-15-1PM-C ADNB025-24-1PM-C ADNB012-48-1PM-C	$I_{O,max}$	0 0 0 0	-	5.0 4.0 2.5 1.25	A A A A
Line Regulation	$V_{IN,DC} = V_{IN,min}$ to $V_{IN,max}$ $I_O = I_{O,max}$	V_O	-1.0	-	+1.0	%
Load Regulation	$I_O = I_{O,min}$ to $I_{O,max}$	V_O	-1.0	-	+1.0	%
V_O Over Voltage Protection	Latch off (AC recycle to reset)	V_O	115	-	150	%
V_O Over Current Protection ¹	All	I_O	102	-	-	% $I_{O,max}$

Note 1 - Hiccup mode and auto recovery after fault condition is removed.

ADNB050-12-1PM-C Performance Curves

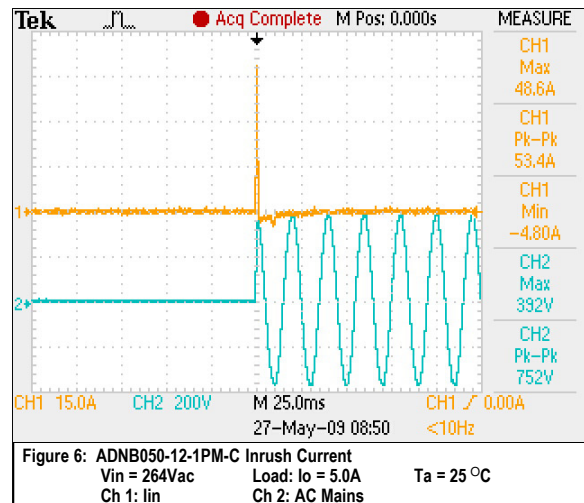
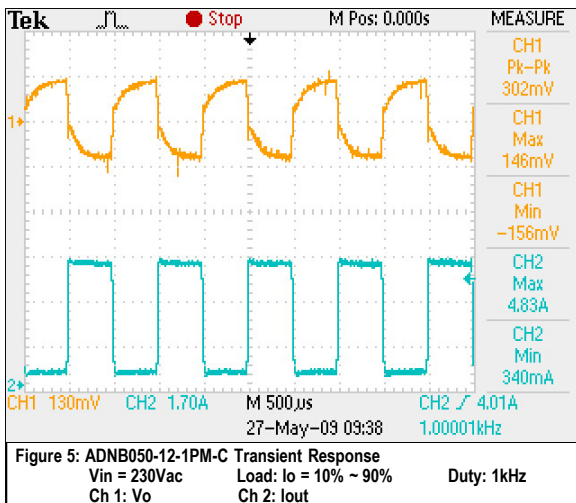
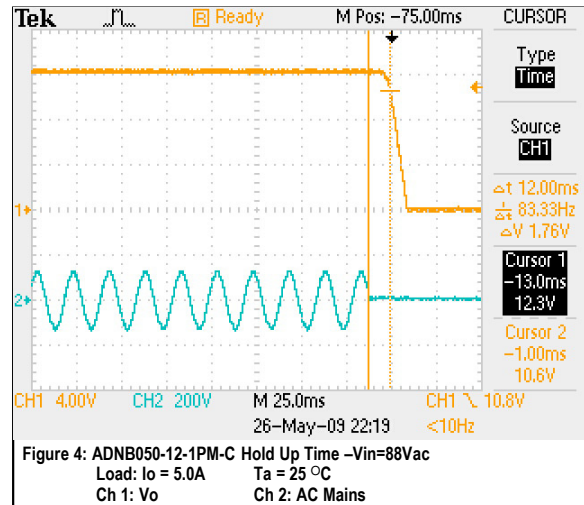
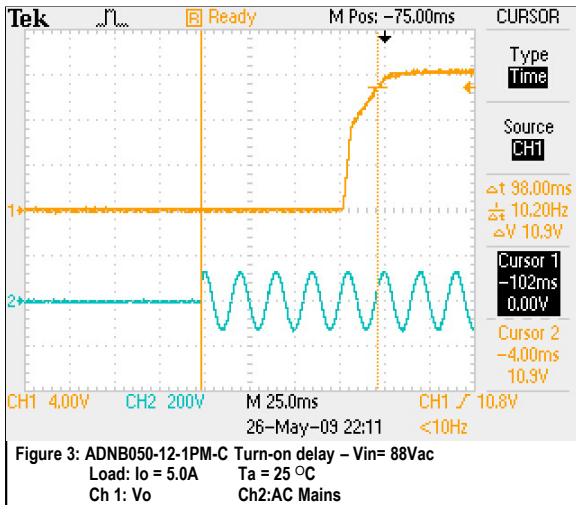
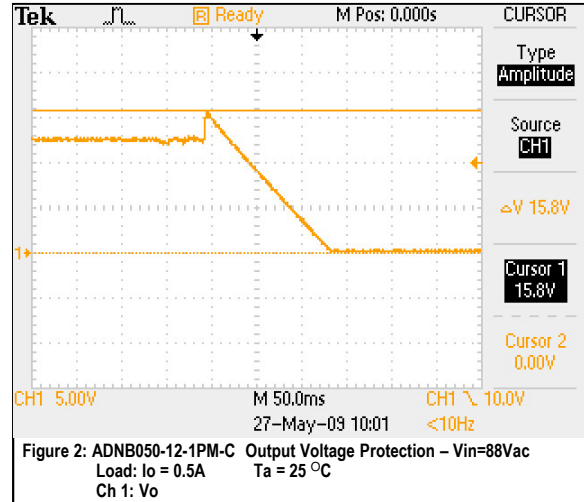
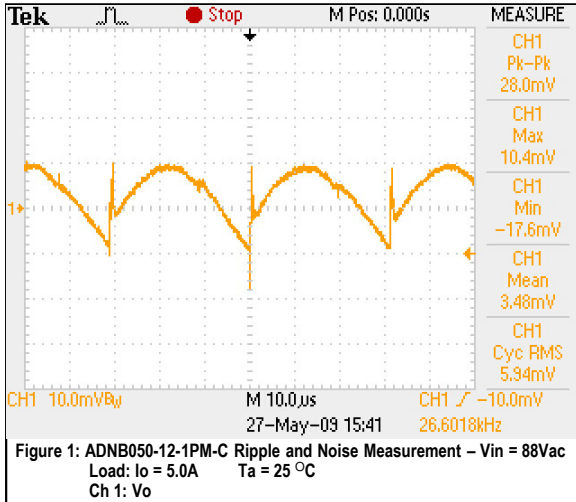

ADNB040-15-1PM-C Performance – Curves

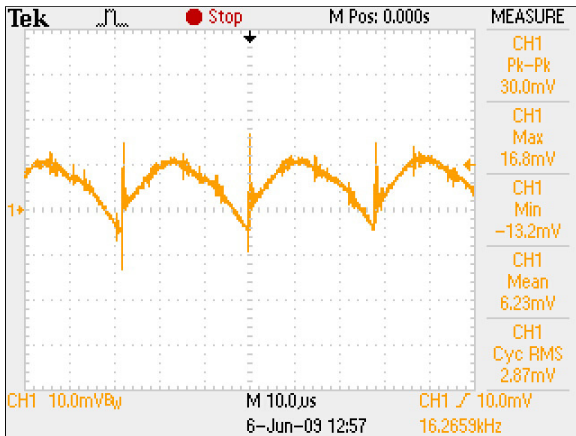

Figure 7: ADNB040-15-1PM-C Ripple and Noise Measurement – Vin = 88Vac
Load: Io = 4.0A Ta = 25 °C
Ch 1: Vo

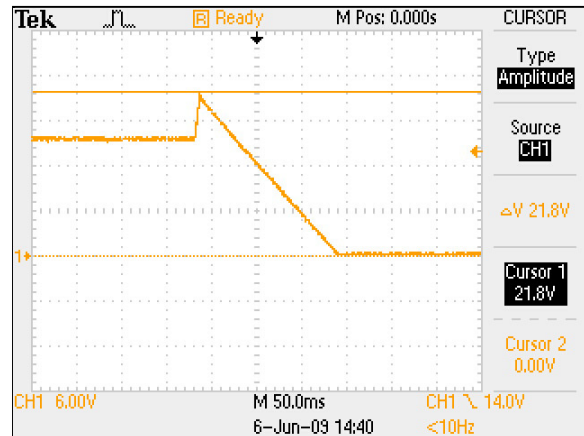

Figure 8: ADNB040-15-1PM-C Output Voltage Protection – Vin=88Vac
Load: Io = 0.4A Ta = 25 °C
Ch 1: Vo

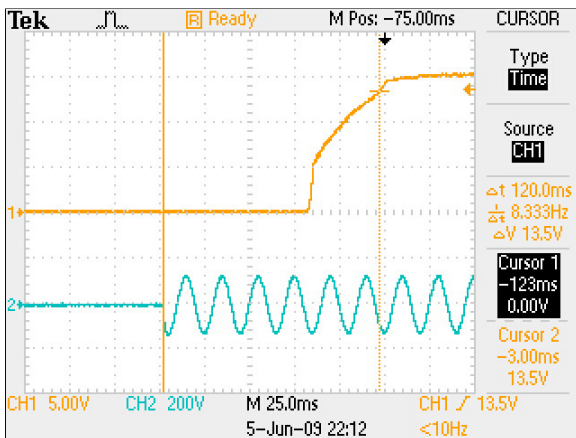

Figure 9: ADNB040-15-1PM-C Turn-on delay – Vin= 88Vac
Load: Io = 4.0A Ta = 25 °C
Ch 1: Vo Ch2:AC Mains

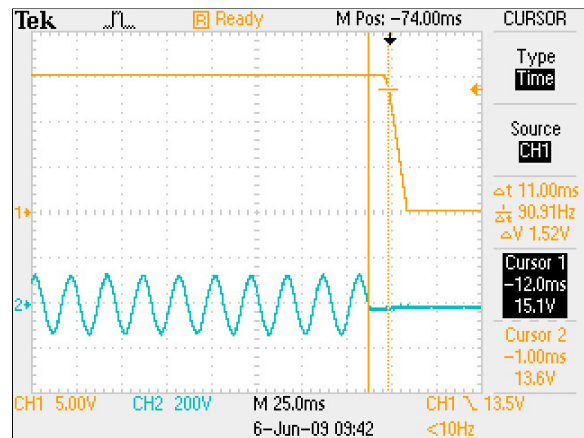

Figure 10: ADNB040-15-1PM-C Hold Up Time –Vin=88Vac
Load: Io = 4.0A Ta = 25 °C
Ch 1: Vo Ch 2: AC Mains

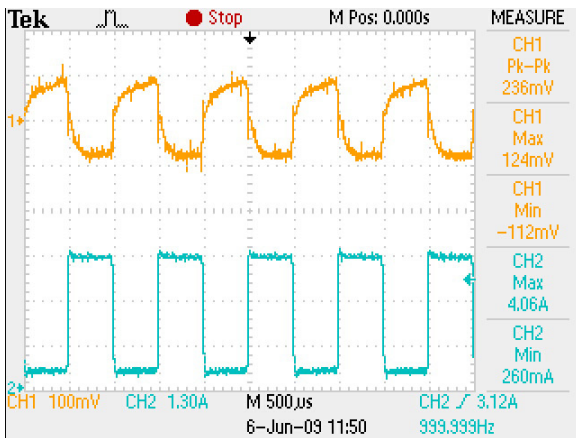

Figure 11: ADNB040-15-1PM-C Transient Response
Vin = 230Vac Load: Io = 10% ~ 90% Duty: 1kHz
Ch 1: Vo Ch 2: Iout

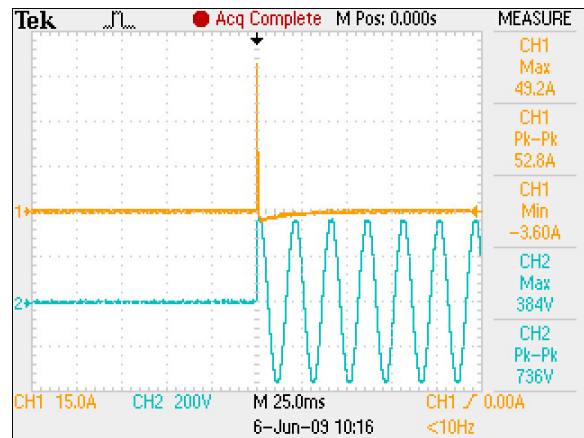

Figure 12: ADNB040-15-1PM-C Inrush Current
Vin = 264Vac Load: Io = 4.0A Ta = 25 °C
Ch 1: Iin Ch 2: AC Mains

ADNB025-24-1PM-C Performance Curves

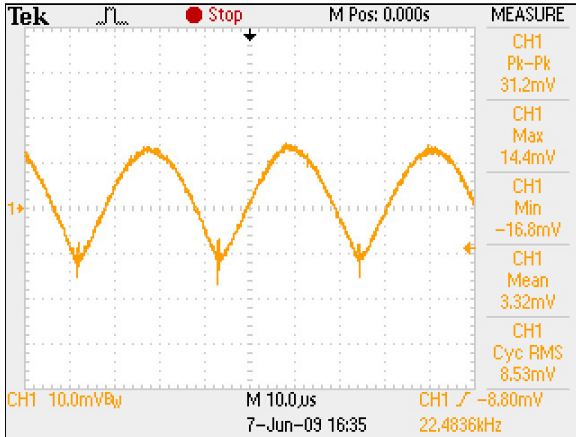

Figure 13: ADNB025-24-1PM-C Ripple and Noise Measurement – Vin = 88Vac
Load: Io = 2.5A Ta = 25 °C
Ch 1: Vo

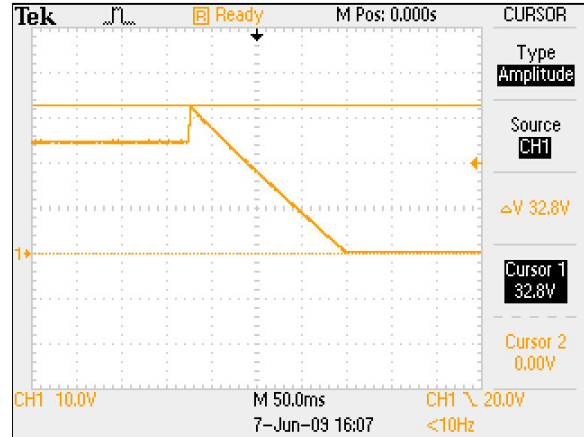

Figure 14: ADNB025-24-1PM-C Output Voltage Protection – Vin=88Vac
Load: Io = 0.25A Ta = 25 °C
Ch 1: Vo

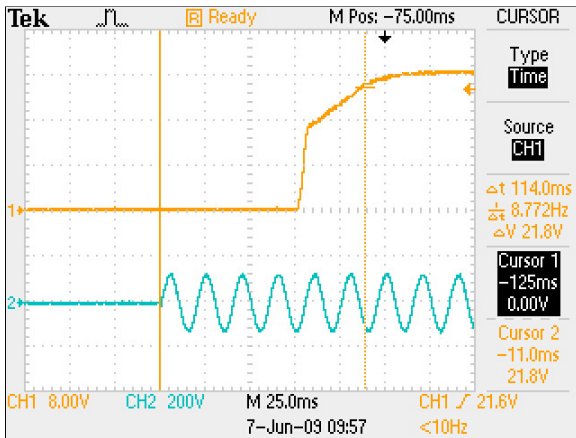

Figure 15: ADNB025-24-1PM-C Turn-on delay – Vin= 88Vac
Load: Io = 2.5A Ta = 25 °C
Ch 1: Vo Ch2: AC Mains

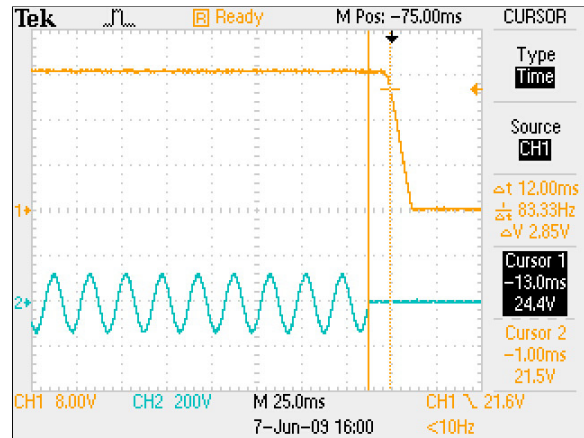

Figure 16: ADNB025-24-1PM-C Hold Up Time –Vin=88Vac
Load: Io = 2.5A Ta = 25 °C
Ch 1: Vo Ch 2: AC Mains

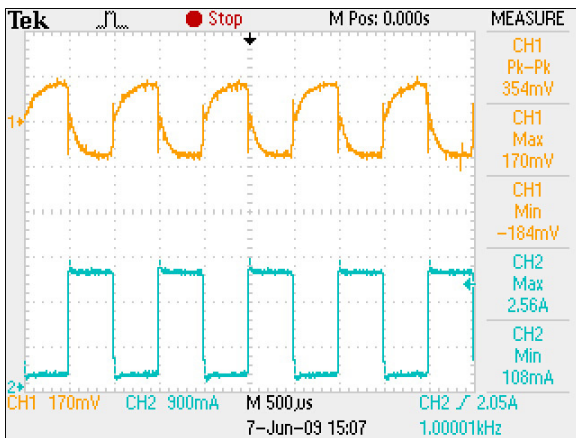

Figure 17: ADNB025-24-1PM-C Transient Response
Vin = 230Vac Load: Io = 10% ~ 90% Duty: 1kHz
Ch 1: Vo Ch 2: Iout

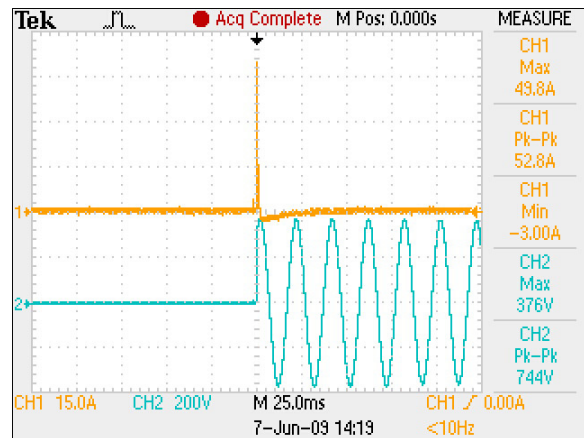
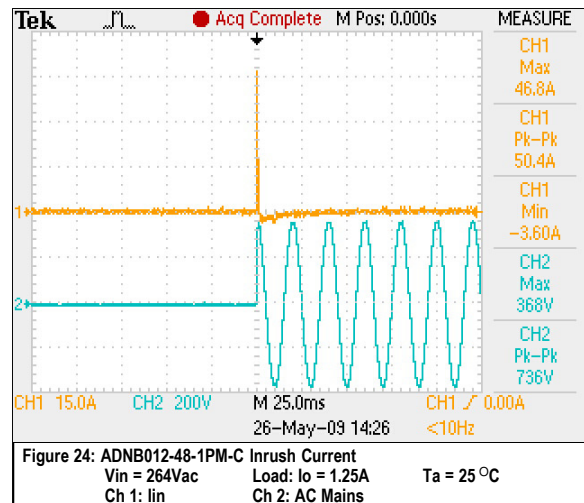
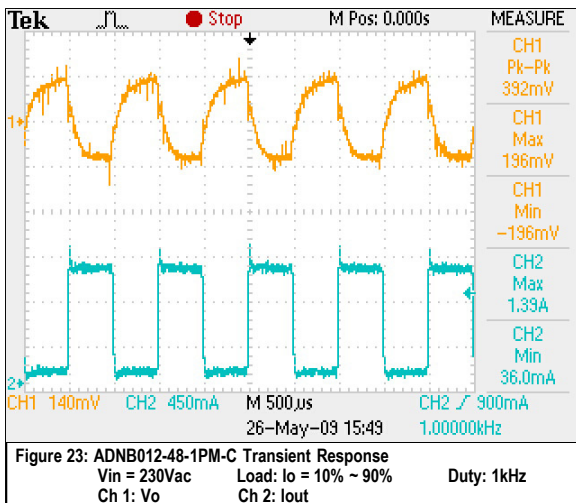
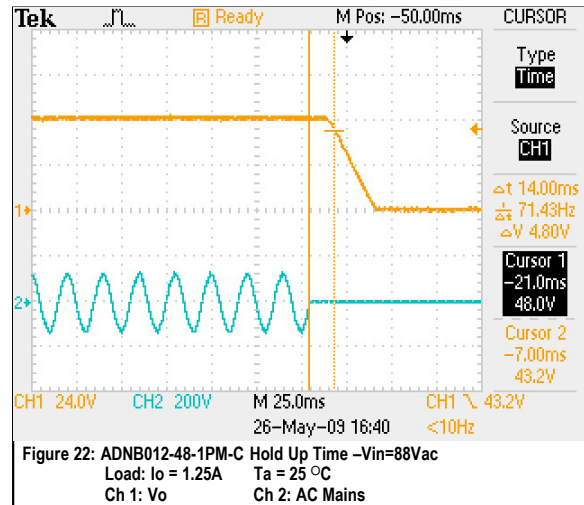
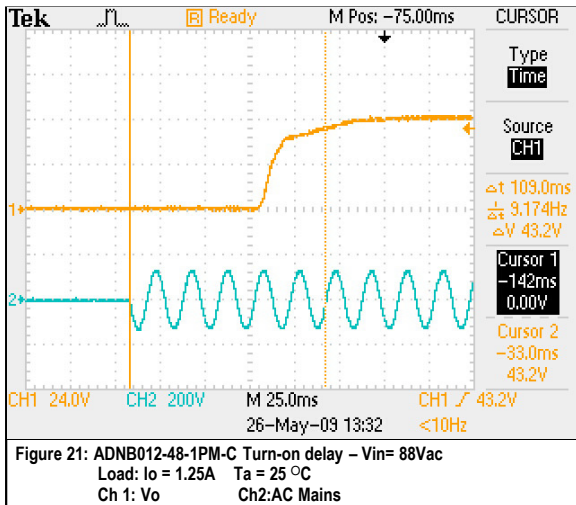
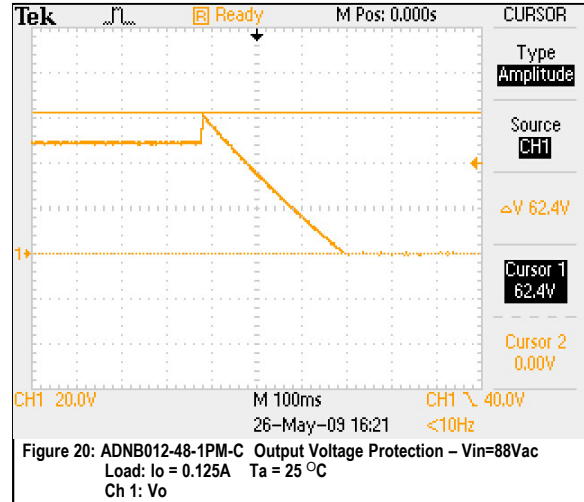
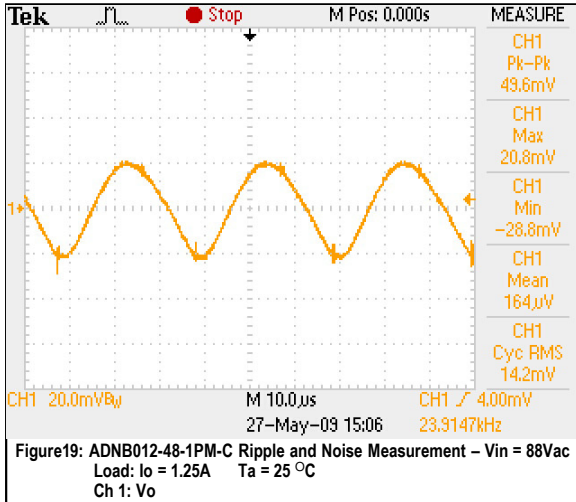

Figure 18: ADNB025-24-1PM-C Inrush Current
Vin = 264Vac Load: Io = 2.5A Ta = 25 °C
Ch 1: Iin Ch 2: AC Mains

ADNB012-48-1PM-C Performance Curves



Protective Function Specifications

Over Voltage Protection (OVP)

The power supply output voltage latches off during output overvoltage with the AC line recycled to reset the latch.

ADNB050-12-1PM-C

Parameter	Min	Nom	Max	Unit
12V Vo Output Overvoltage	13.8	/	18	V

ADNB040-15-1PM-C

Parameter	Min	Nom	Max	Unit
15V Vo Output Overvoltage	17.25	/	22.5	V

ADNB025-24-1PM-C

Parameter	Min	Nom	Max	Unit
24V Vo Output Overvoltage	27.6	/	36	V

ADNB012-48-1PM-C

Parameter	Min	Nom	Max	Unit
48V Vo Output Overvoltage	55.2	/	72	V

Over Current Protection (OCP)

ADNB 60W series power supply includes internal current limit circuitry to prevent damage in the event of overload or short circuit. In the event of overloads, it will go to hiccup mode, the output voltage may deviate from the regulation band but recovery is automatic when the load is reduced to within specified limits.

ADNB050-12-1PM-C

Parameter	Min	Nom	Max	Unit
12V Vo Output Overcurrent	5.1	/	/	A

ADNB040-15-1PM-C

Parameter	Min	Nom	Max	Unit
15V Vo Output Overcurrent	4.08	/	/	A

ADNB025-24-1PM-C

Parameter	Min	Nom	Max	Unit
24V Vo Output Overcurrent	2.55	/	/	A

ADNB012-48-1PM-C

Parameter	Min	Nom	Max	Unit
48V Vo Output Overcurrent	1.275	/	/	A

Mechanical Specifications

Mechanical Drawing (Dimensioning and Mounting Locations)

Unit : mm / inch

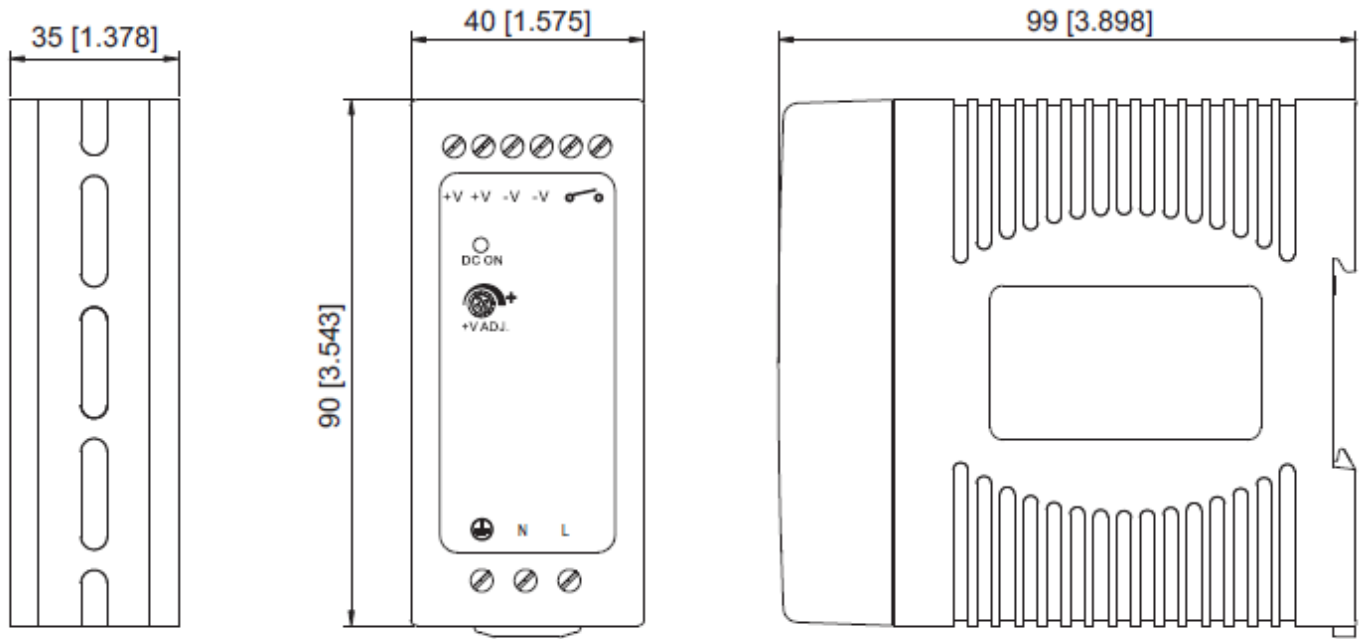

install DIN rail TS-35 / 7.5 or TS-35 / 15

Weight

The ADNB 60W series packing weight is 0.661lb/300g typical.

Environmental Specifications

EMC Immunity

ADNB 60W series power supply is designed to meet the following EMC immunity specifications:

Table 4. Environmental Specifications:

Document	Description
EN 55022	Conducted Level B and Radiated Level B (stand alone)
EN 61000-3-2	Harmonic Distortion
EN 61000-3-3	Harmonic Distortion
EN 61204-3	EMS immunity
EN 55024	EMS immunity

Safety Certifications

The ADNB 60W series power supply is intended for inclusion in other equipment and the installer must ensure that it is in compliance with all the requirements of the end application. This product is only for inclusion by professional installers within other equipment and must not be operated as a stand alone product.

Table 5. Safety Certifications for ADNB 60W series power supply system:

Document	Description
UL/cUL508/UL1310	US and Canada Requirements
TUV EN60950-1	Germany and European Requirements (All CENELEC Countries)

EMI Emissions

The ADNB 60W series has been designed to comply with the Class B limits of EMI requirements of EN55022 (FCC Part 15) and CISPR 22 (EN55022) for emissions and relevant sections of EN61000 (IEC 61000) for immunity.

The unit is enclosed inside a metal box, tested at full load using resistive load.

Conducted Emissions

The applicable standard for conducted emissions is EN55022 (FCC Part 15). Conducted noise can appear as both differential mode and common mode noise currents. Differential mode noise is measured between the two input lines, with the major components occurring at the supply fundamental switching frequency and its harmonics. Common mode noise, a contributor to both radiated emissions and input conducted emissions, is measured between the input lines and system ground and can be broadband in nature.

Table 6. Conducted EMI emission specifications of the ADNB 60W series

Parameter	Model	Symbol	Min	Typ	Max	Unit
FCC Part 15, class B	All	Margin	-	-	6	dB
CISPR 22 (EN55022) class B	All	Margin	-	-	6	dB

Radiated Emissions

Unlike conducted EMI, radiated EMI performance in a system environment may differ drastically from that in a stand-alone power supply. It is thus recommended that radiated EMI be evaluated in a system environment. The applicable standard is EN55022 Class B (FCC Part 15). Testing ac-dc convertors as a stand-alone component to the exact requirements of EN55022 can be difficult, because the standard calls for 1m leads to be attached to the input and outputs and aligned such as to maximize the disturbance. In such a set-up, it is possible to form a perfect dipole antenna that very few ac-dc convertors could pass. However, the standard also states that 'an attempt should be made to maximize the disturbance consistent with the typical application by varying the configuration of the test sample.

Operating Temperature

The ADNB 60W series start and operate within stated specifications at an ambient temperature from -25°C to 70°C under all load conditions (see below derating curves for other amount of convection and orientation. Derate output current and power by 2.5% per degree above 50°C . Maximum operating ambient temperature is 70°C (which implies a 50% derating at max 70°C ambient).

Under convection cooling condition, the maximum output power derates linearly from full load. When input voltage is 90Vac, the maximum output power will derate to 90% full load.

Derating Curve

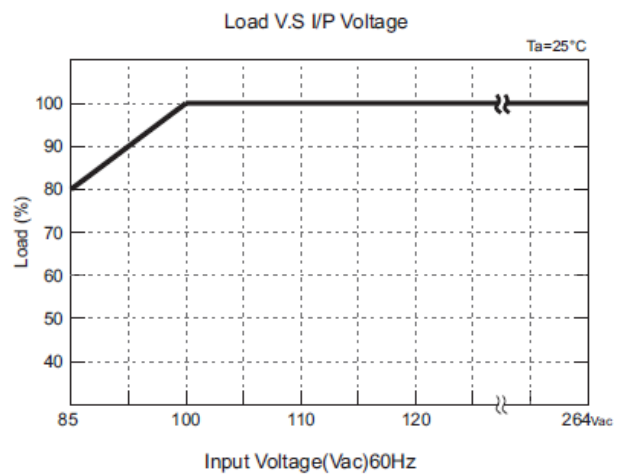
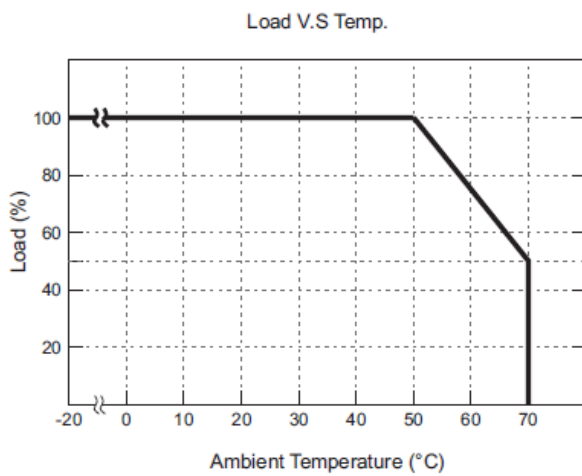

Storage and Shipping Temperature / Humidity

The ADNB 60W series can be stored or shipped at temperatures between -40 °C to +85 °C and relative humidity from 10% to 95%, non-condensing.

Humidity

The ADNB 60W series will operate within specifications when subjected to a relative humidity from 20% to 90% non-condensing. The ADNB 60W series can be stored in a relative humidity from 10% to 95% non-condensing.

Vibration

The ADNB 60W series will pass the following vibration specifications:

Acceleration	2	gRMS
Frequency Range	10-500	Hz
Duration	10	mins
Direction	3 mutually perpendicular axis	
PSD Profile	FREQ 10-500 Hz	SLOPE dB/oct ---
		PSD g²/Hz ---

Application Notes

Block Diagram

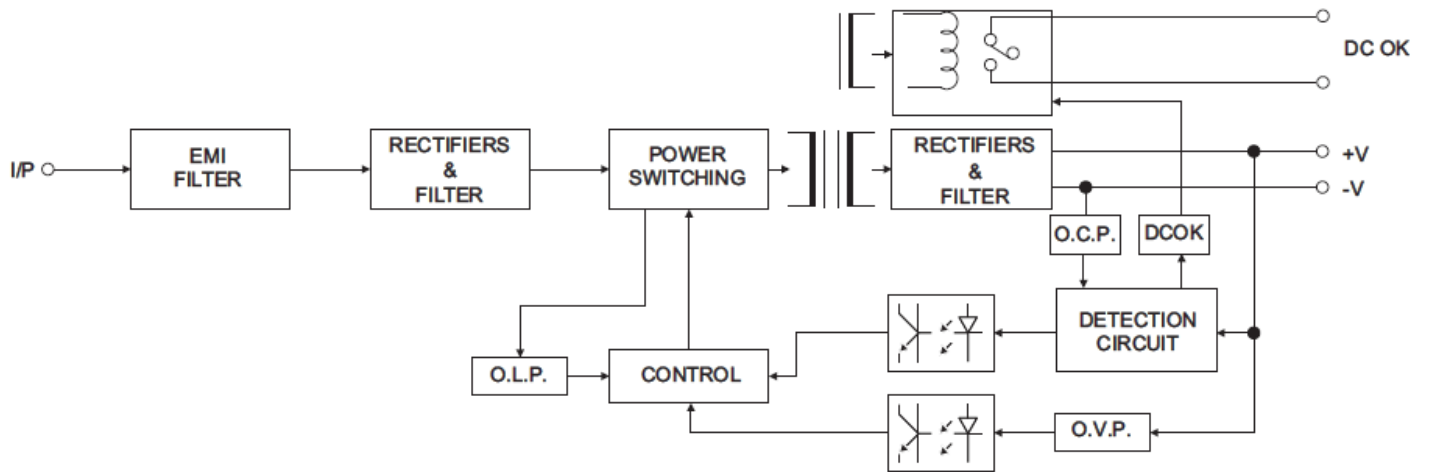

DC OK Relay Contact

Contact Close	When the output voltage reaches the adjusted output voltage
Contact Open	When the output voltage drop below 90% output voltage
Contact Ratings(max.)	30V/1A resistive load

Output Ripple and Noise Measurement

The setup outlined in the diagram below has been used for output voltage ripple and noise measurements on the ADNB 60W series . When measuring output ripple and noise, a scope jack in parallel with a 0.1uF ceramic chip capacitor, and a 47uF aluminum electrolytic capacitor should be used. Oscilloscope should be set to 20MHz bandwidth for this measurement.

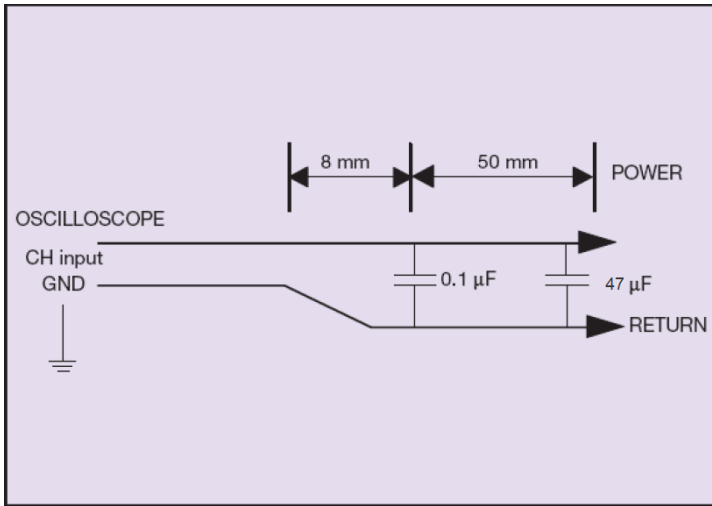

Record of Revision and Changes

Issue	Date	Description	Originators
1.0	04.19.2016	First Issue	E. Bai
1.2	11.02.2016	Updated the MTBF Value	K. Wang
1.3	11.22.2016	Updated the OCP mode	A. Zhang

WORLDWIDE OFFICES

Americas

2900 S.Diablo Way
Tempe, AZ 85282
USA
+1 888 412 7832

Europe (UK)

Waterfront Business Park
Merry Hill, Dudley
West Midlands, DY5 1LX
United Kingdom
+44 (0) 1384 842 211

Asia (HK)

14/F, Lu Plaza
2 Wing Yip Street
Kwun Tong, Kowloon
Hong Kong
+852 2176 3333



www.artesyn.com

While every precaution has been taken to ensure accuracy and completeness in this literature, Artesyn Embedded Technologies assumes no responsibility, and disclaims all liability for damages resulting from use of this information or for any errors or omissions. Artesyn Embedded Technologies, Artesyn and the Artesyn Embedded Technologies logo are trademarks and service marks of Artesyn Technologies, Inc. All other names and logos referred to are trade names, trademarks, or registered trademarks of their respective owners.
© 2014 All rights reserved.

For more information: www.artesyn.com/power
For support: productsupport.ep@artesyn.com