

# **AN-1779 LM2756 Multi-Display Inductorless LED Driver with 32 Exponential Dimming Steps in $\mu$ SMD**

---

## ABSTRACT

This application note discusses the ways in which the LM2756 can be configured to drive the eight LEDs in numerous configurations.

## Contents

1	Typical Application .....	3
2	Basic Description .....	3
3	Bill of Materials .....	3
4	LM2756 Evaluation Board Schematic .....	4
5	LM2756 Evaluation Board Layout .....	4
6	Board Operation .....	6
	6.1 Basic Connections .....	6
	6.2 External Control Interface Connection .....	6
	6.3 Operation Description .....	6
7	Software Interface Information .....	11

## List of Figures

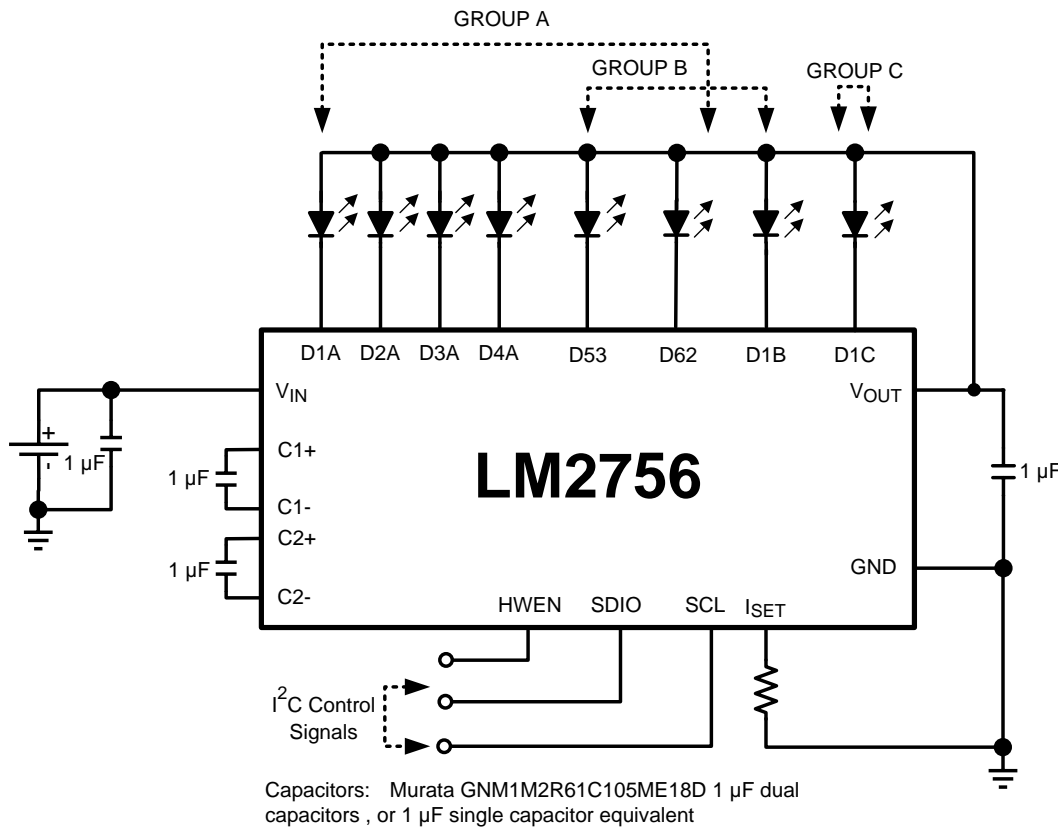
1	Top Layer .....	4
2	Middle Layer 1 .....	5
3	Middle Layer 2 .....	5
4	Bottom Layer (unmirrored) .....	5
5	Data Validity Diagram .....	6
6	Start and Stop Conditions .....	7
7	Write Cycle .....	7
8	Chip Address .....	7
9	General Purpose Register Description Internal Hex Address: 10h .....	8
10	Brightness Control Register Description Internal Hex Address: 0xA0 (GroupA), 0xB0 (GroupB), 0xC0 (GroupC) .....	8
11	Ramp Step Time Register Description Internal Hex Address: 20h .....	10
12	VF Monitor Delay Register Description Internal Hex Address: 60h .....	10
13	GUI Start-Up .....	11
14	Generic Read/Write Field .....	12
15	Drop Down Menu .....	12
16	Control and Configuration Buttons .....	12
17	Brightness Control Sliders .....	12
18	BankA Ramp Step Time .....	13
19	Results of Pressing the Set Button .....	13
20	Example Configuration .....	13

## List of Tables

---

1	Brightness Level Control Table (GroupA) .....	9
2	Brightness Ramp-Up/Ramp-Down Times .....	11

## 1 Typical Application



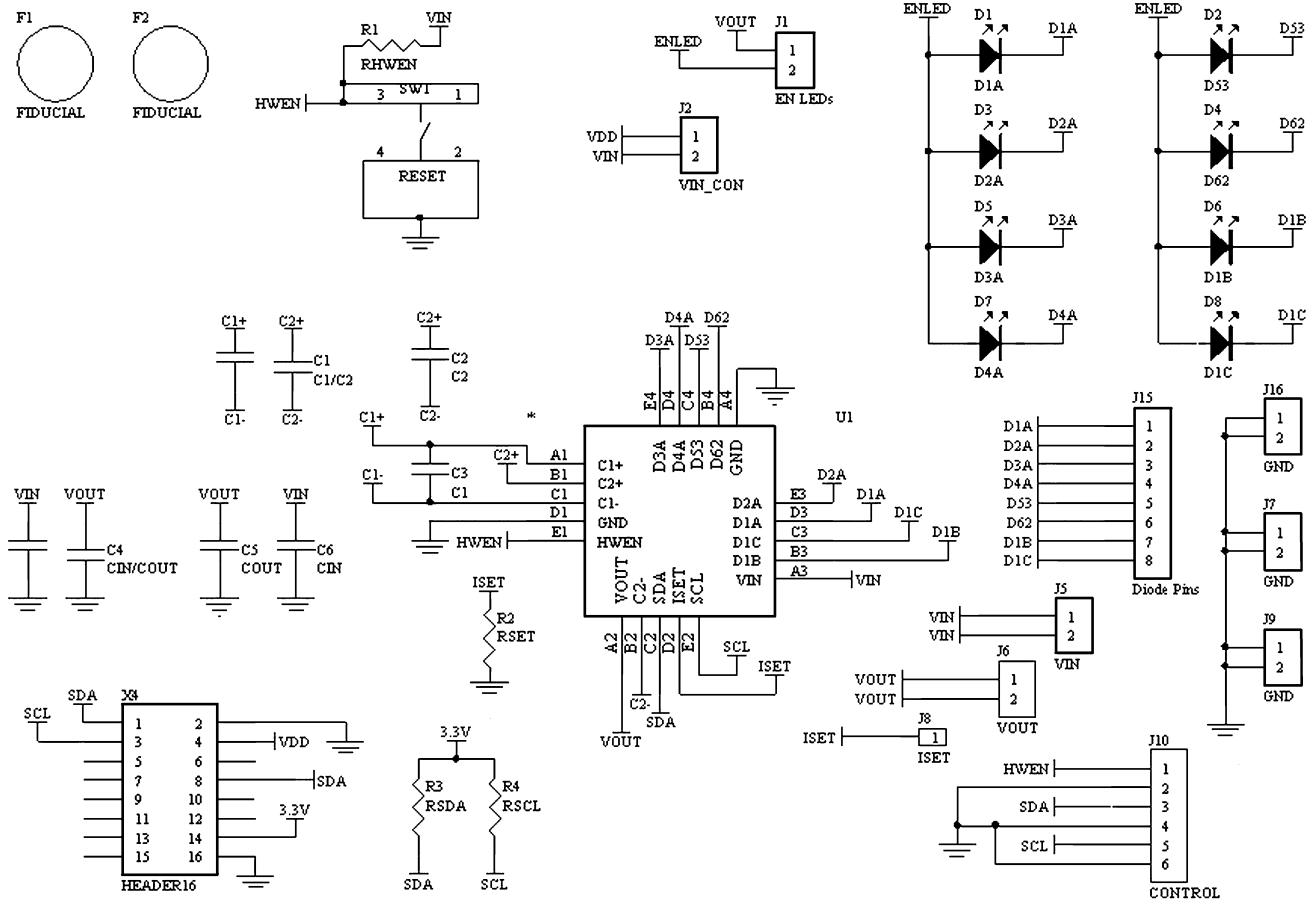
## 2 Basic Description

The LM2756 is a highly integrated, switched-capacitor, multi-display LED driver that can drive up to eight LEDs in parallel. The regulated internal current sources on the evaluation boards are set-up to deliver 20mA to each LED delivering excellent current and brightness matching. Utilizing the I<sup>2</sup>C compatible interface, the user can configure the LM2756 evaluation board to drive the eight LEDs in any of the numerous LED group configurations (4:3:1, 5:2:1, 6:1:1, etc.).

## 3 Bill of Materials

Component Symbol	Value	Manufacturer	Part #
LM2756	--	Texas Instruments	LM2756SDX
LM2756 Evaluation Board	--	Texas Instruments	551013004-002 RevA
D1A-D4A, D53B,D62,D1B,D1C	White LED	Nichia	NSSW020BT
C <sub>OUT</sub> /C <sub>IN</sub>	1µF, 16V Dual Capacitor	Murata	GNM1M2R61C105 ME18D
C <sub>2</sub> /C <sub>1</sub>	1µF, 16V Dual Capacitor	Murata	GNM1M2R61C105 ME18D
R <sub>SET</sub>	11.8kΩ	Vishay Dale	CRCW04021182F
RSCL, RSDA,RHWEN	10kΩ	Vishay Dale	CRCW08051002F
RESET	Momentary Switch	Panasonic	EVQ-P2K02Q
X4	USB Dock Connector	3M	8516-4500JL

### 4 LM2756 Evaluation Board Schematic



### 5 LM2756 Evaluation Board Layout

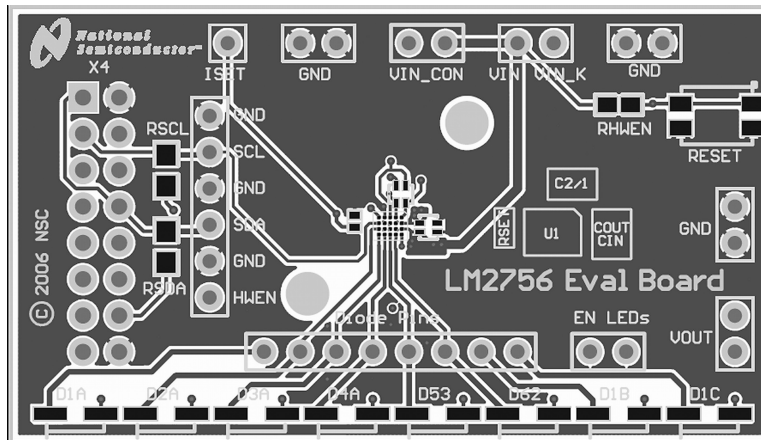
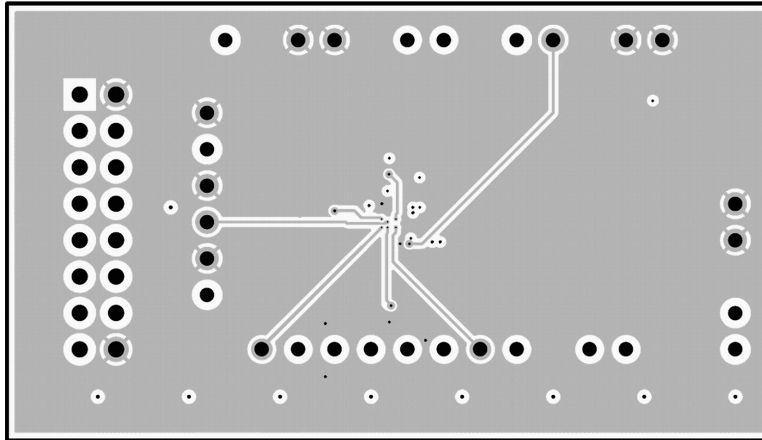
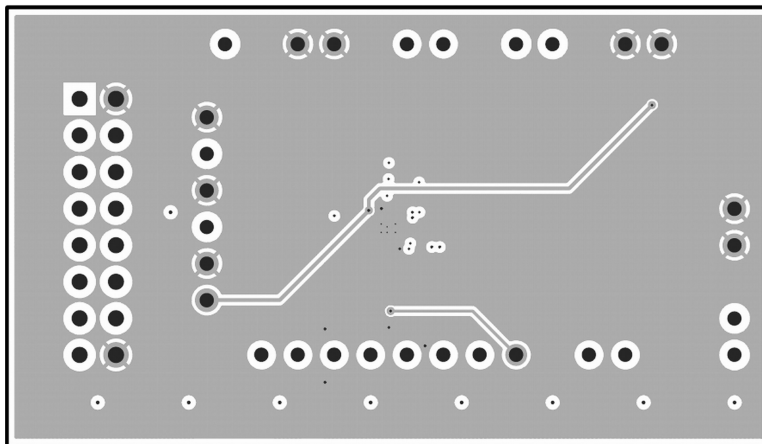


Figure 1. Top Layer

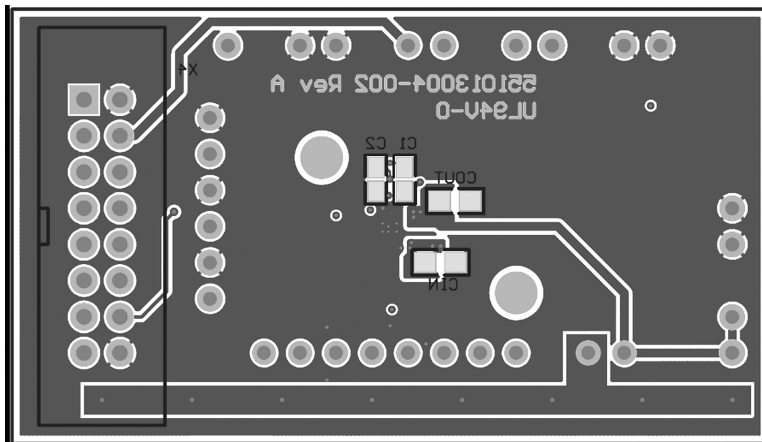




**Figure 2. Middle Layer 1**



**Figure 3. Middle Layer 2**



**Figure 4. Bottom Layer (unmirrored)**

## 6 Board Operation

### 6.1 Basic Connections

To operate the LM2756 Multi-Display Inductorless LED Driver with 32 Exponential Dimming Steps in  $\mu$ SMD, connect a supply voltage (2.7V-5.5V) between board connectors VIN and GND and attach an I<sup>2</sup>C interface using one of the methods described in . There is a RESET button provided on the board to exercise the RESET pin on the LM2756. By default, this pins is pulled high through a resistor to allow normal operation. Depressing this button during board operation will shutdown the LM2756 and will clear all of the internal registers resetting them to their default values.

Default Jumper Connections:

- EN\_LEDS: This connects VOUT to the anodes of the LEDs. Removing the jumper disconnects the on-board LED power and allows external diodes / measurement equipment to be connected between VOUT and the Dx Pins
- VIN\_CON: Connects the adjustable voltage supply of the USB Docking board to the VIN of the LM2756. If the USB board is not used, this jumper does not need to be placed. If the USB Docking board is going to be used for the I<sup>2</sup>C interface, but not for VIN, make sure the VIN\_CON jumper is removed.

With the default jumper connections made, the board will be ready to operate once an input voltage and an I<sup>2</sup>C interface generator (external or USB docking board) are connected.

### 6.2 External Control Interface Connection

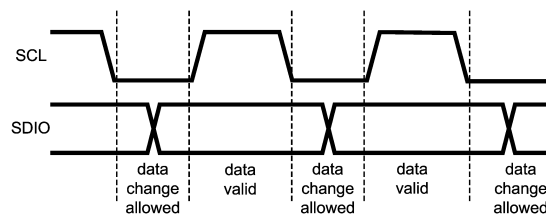
The LM2756 evaluation board provides two ways to connect an I<sup>2</sup>C compatible interface to the LM2756 IC. The first method to connect the interface is through a set of connectors on the bottom of the evaluation board that allow the board to plug into TI's USB interface board directly. The second method of interface connection is through a header strip located on the left hand side of the evaluation board. There are pins available to connect VIO (controller reference voltage), SCL (Interface Clock Line), and SDA (Interface Data Line) each separated by a ground pin. The evaluation board has two external pull-ups that connect both SCL and SDA to VIO to compliment the open drain inputs found on the LM2756. [Section 6.3](#) describes the internal registers and I<sup>2</sup>C compatible interface in greater detail.

### 6.3 Operation Description

#### 6.3.1 I<sup>2</sup>C Compatible Interface

##### 6.3.1.1 Data Validity

The data on SDIO line must be stable during the HIGH period of the clock signal (SCL). In other words, state of the data line can only be changed when SCL is LOW.



**Figure 5. Data Validity Diagram**

A pull-up resistor between the controller's VIO line and SDIO must be greater than  $[(VIO - V_{OL}) / 3.5mA]$  to meet the  $V_{OL}$  requirement on SDIO. Using a larger pull-up resistor results in lower switching current with slower edges, while using a smaller pull-up results in higher switching currents with faster edges.

### 6.3.1.2 Start and Stop Conditions

START and STOP conditions classify the beginning and the end of the I<sup>2</sup>C session. A START condition is defined as SDIO signal transitioning from HIGH to LOW while SCL line is HIGH. A STOP condition is defined as the SDIO transitioning from LOW to HIGH while SCL is HIGH. The I<sup>2</sup>C master always generates START and STOP conditions. The I<sup>2</sup>C bus is considered to be busy after a START condition and free after a STOP condition. During data transmission, the I<sup>2</sup>C master can generate repeated START conditions. First START and repeated START conditions are equivalent, function-wise.

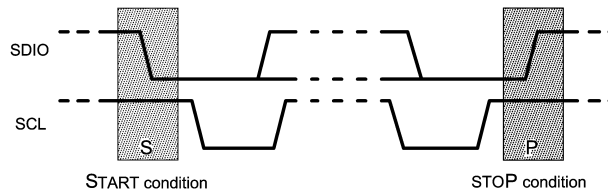
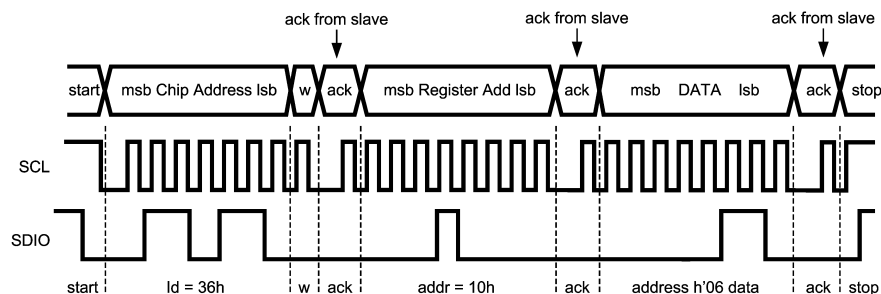


Figure 6. Start and Stop Conditions

### 6.3.1.3 Transferring Data

Every byte put on the SDIO line must be eight bits long, with the most significant bit (MSB) transferred first. Each byte of data has to be followed by an acknowledge bit. The acknowledge related clock pulse is generated by the master. The master releases the SDIO line (HIGH) during the acknowledge clock pulse. The LM2756 pulls down the SDIO line during the 9th clock pulse, signifying an acknowledge. The LM2756 generates an acknowledge after each byte is received.

After the START condition, the I<sup>2</sup>C master sends a chip address. This address is seven bits long followed by an eighth bit which is a data direction bit (R/W). The LM2756 address is 36h. For the eighth bit, a “0” indicates a WRITE and a “1” indicates a READ. The second byte selects the register to which the data will be written. The third byte contains data to write to the selected register.



w = write (SDIO = "0")  
 r = read (SDIO = "1")  
 ack = acknowledge (SDIO pulled down by either master or slave)  
 id = chip address, 36h for LM2756

Figure 7. Write Cycle

### 6.3.1.4 I<sup>2</sup>C Compatible Chip Address

The chip address for LM2756 is 0110110, or 36h.

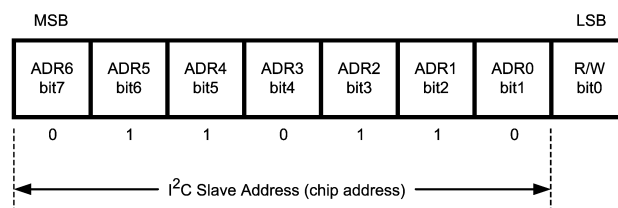
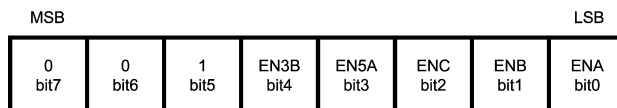


Figure 8. Chip Address

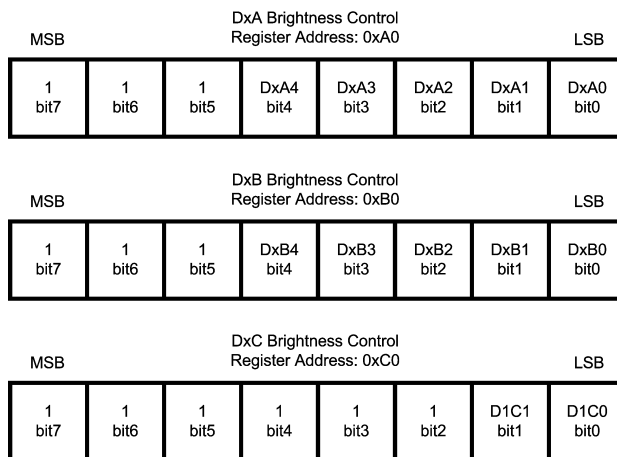
### 6.3.1.5 Internal Registers of LM2756

Register	Internal Hex Address	Power On Value
General Purpose Register	10h	0000 0000
Group A Brightness Control Register	A0h	1110 0000
Group B Brightness Control Register	B0h	1111 1000
Group C Brightness Control Register	C0h	1111 1000
Ramp Step Time Register	20h	1111 0000
VF Monitor Delay Register	60h	1111 1100



**Figure 9. General Purpose Register Description**  
Internal Hex Address: 10h

- 
- NOTE:** ENA: Enables DxA LED drivers (Main Display)  
 ENB: Enables DxB LED drivers (Aux Lighting)  
 ENC: Enables D1C LED driver (Indicator Lighting)  
 SD53: Shuts down driver D53  
 SD62: Shuts down driver D62  
 53A: Configures D53 to GroupA  
 62A: Configures D62 to GroupA
- 



**Figure 10. Brightness Control Register Description**  
Internal Hex Address: 0xA0 (GroupA), 0xB0 (GroupB), 0xC0 (GroupC)

**NOTE:** DxA4-DxA0, D53, D62: Sets Brightness for DxA pins (GroupA). 11111=Fullscale

DxB2-DxB0: Sets Brightness for DxB pins (GroupB). 111=Fullscale

DxC2-DxC0: Sets Brightness for D1C pin. 111 = Fullscale

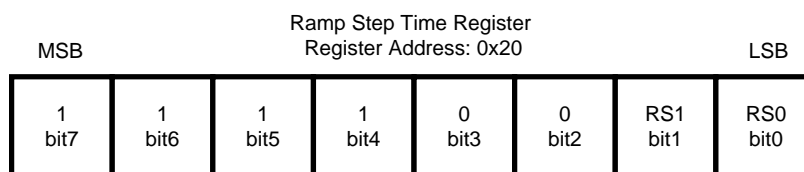
Full-Scale Current set externally by the following equation:

$$I_{Dxx} = 189 \times 1.25V / R_{SET}$$

**Table 1. Brightness Level Control Table (GroupA)**

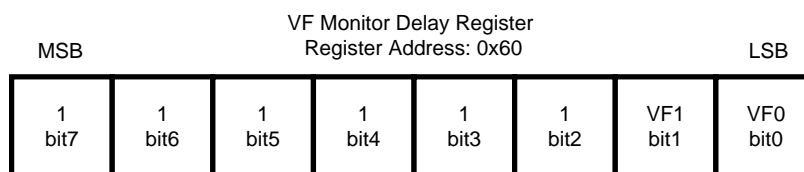
Brightness Code (hex)	Perceived Brightness Level (%)
00	0.125
01	0.313
02	0.625
03	1
04	1.125
05	1.313
06	1.688
07	2.063
08	2.438
09	2.813
0A	3.125
0B	3.75
0C	4.375
0D	5.25
0E	6.25
0F	7.5
10	8.75
11	10
12	12.5
13	15
14	16.875
15	18.75
16	22.5
17	26.25
18	31.25
19	37.5
1A	43.75
1B	52.5
1C	61.25
1D	70
1E	87.5
1F	100

GroupB and GroupC Brightness Levels (% of Full-Scale) = 10%, 20%, 30%, 40%, 50%, 60%, 70%, 100%



**Figure 11. Ramp Step Time Register Description Internal Hex Address: 20h**

**NOTE:** RS1-RS0: Sets Brightness Ramp Step Time. The Brightness ramp settings only affect GroupA current sinks. ('00' = 100µs, '01' = 25ms, '10' = 50ms, '11' = 100ms).



**Figure 12. VF Monitor Delay Register Description Internal Hex Address: 60h**

**NOTE:** VF1-VF0: Sets the Gain Transition Delay Time. The VF Monitor Delay can be set to four different delay times. ('00' (Default) = 3-6msec., '01' = 1.5-3msec., '10' = 0.4msec., '11' = 60-90µsec.).

### 6.3.2 LED Configurations

The LM2756 has a total of eight current sinks capable of sinking 180mA of total diode current. These 8 current sinks are configured to operate in three independently controlled lighting regions. GroupA has four dedicated current sinks, while GroupB and GroupC each have one. To add greater lighting flexibility, the LM2756 has two additional drivers (D53 and D62) that can be assigned to either GroupA or GroupB through a setting in the general purpose register.

At start-up, the default condition is four LEDs in GroupA, three LEDs in GroupB and a single LED in GroupC (NOTE: GroupC only consists of a single current sink (D1C) under any configuration). Bits 53A and 62A in the general purpose register control where current sinks D53 and D62 are assigned. By writing a '1' to the 53A or 62A bits, D53 and D62 become assigned to the GroupA lighting region. Writing a '0' to these bits assigns D53 and D62 to the GroupB lighting region. With this added flexibility, the LM2756 is capable of supporting applications requiring 4, 5, or 6 LEDs for main display lighting, while still providing additional current sinks that can be used for a wide variety of lighting functions.

### 6.3.3 Setting Led Current

The current through the LEDs connected to DxA and DxB can be set to a desired level simply by connecting an appropriately sized resistor (R<sub>SET</sub>) between the I<sub>SET</sub> pin of the LM2756 and GND. The DxA, DxB and D1C LED currents are proportional to the current that flows out of the I<sub>SET</sub> pin and are a factor of 189 times greater than the I<sub>SET</sub> current. The feedback loops of the internal amplifiers set the voltage of the I<sub>SET</sub> pin to 1.25V (typ.). The statements above are simplified in the equations below:

$$I_{DxA/B/C} (A) = 189 \times (V_{ISET} / R_{SET}) \quad R_{SET} (\Omega) = 189 \times (1.25V / I_{DxA/B/C}) \quad (1)$$

Once the desired R<sub>SET</sub> value has been chosen, the LM2756 has the ability to internally dim the LEDs using analog current scaling. The analog current level is set through the I<sup>2</sup>C compatible interface. LEDs connected to GroupA can be dimmed to 32 different levels. GroupB and GroupC(D1C) have 8 analog current levels.

Please refer to [Section 6.3.1](#) for detailed instructions on how to adjust the brightness control registers.

### 6.3.4 LED Current Ramping

The LM2756 provides an internal LED current ramping function that allows the GroupA LEDs to turn on and turn off gradually over time. The target current level is set in the GroupA Brightness Control Register (0xA0). The total ramp-up/ramp-down time is determined by the GroupA brightness level (0-31) and the user configurable ramp step time.

Bits RS1 and RS2 in the Ramp Step Time Register (0x20) set the ramp step time to the following four times: '00' = 100µsec., '01' = 25msec., '10' = 50msec., '11' = 100msec.

The LM2756 will always ramp-up (upon enable) and ramp-down (upon disable) through the brightness levels until the target level is reached. At the default setting of '00', the LM2756's current ramping feature looks more like a current step rather than a current ramp. Table 2 the approximate ramp-up/ramp-down times if the GroupA brightness register is set to full-scale, or brightness code 31.

**Table 2. Brightness Ramp-Up/Ramp-Down Times**

Ramp Code RS1-RS0	Ramp Step Time	Total Ramp Time
00	100µs	3.2ms
01	25ms	0.8s
10	50ms	1.6s
11	100ms	3.2s

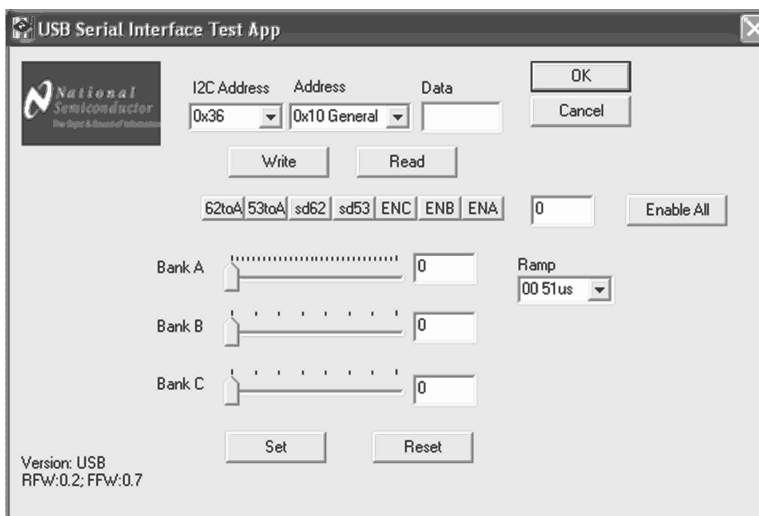
## 7 Software Interface Information

In order to fully evaluate the LM2756 part, an I<sup>2</sup>C Compatible interface must be used for any functionality to occur. A detailed description of the interface control is described in the LM2756 data sheet.

Texas Instruments has created an I<sup>2</sup>C compatible interface generation program and USB docking board that can help exercise the part in a simple way. Contained in this document is a description of how to use the USB docking board and interface software.

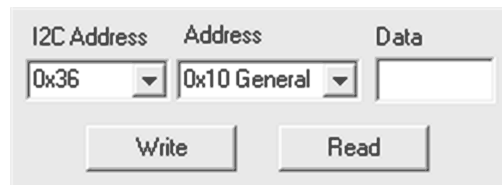
The LM2756 evaluation board has the means to “plug into” the USB docking board. The USB docking board can provide all of the control signals and power required to operate the evaluation board. A standard USB cable must be connected to the board from a PC.

The I<sup>2</sup>C compatible interface program provides all of the control that the LM2756 part requires. For proper operation, the USB docking board should be plugged into the PC before the interface program is opened. Once connected, and the program is executed, a basic interface window will open.

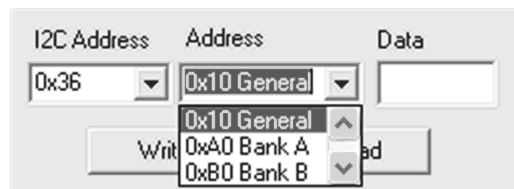


**Figure 13. GUI Start-Up**

At the top of the interface, the user can read or write to any of the data registers on the LM2756 part using the two pull down menus (for the slave i.d. and the desired data address), the data field, and the read and write buttons.



**Figure 14. Generic Read/Write Field**



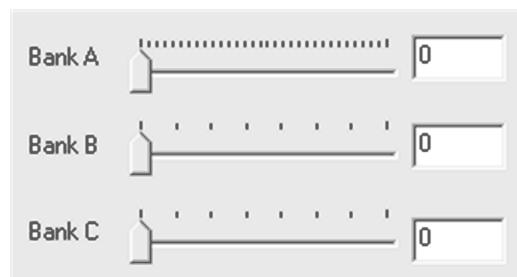
**Figure 15. Drop Down Menu**

Just below the pull down menus are convenient toggle buttons to set/reset the control bits in the General Purpose Register.



**Figure 16. Control and Configuration Buttons**

- 62toA and 53toA: Assigns D62 and D63 current sinks to BankA when depressed. By default, D62 and D53 are assigned to BankB
- SD62 and SD53: Disabled drivers D62 and D53 when depressed
- ENC, ENB and ENA: These bits, when depressed, enable BankA, BankB and BankC.



**Figure 17. Brightness Control Sliders**

- BankA Slider: Sets the BankA brightness to any allowable brightness code (0 to 31)
- BankB Slider: Sets the BankB brightness to any allowable brightness code (0 to 7)
- BankC Slider: Sets the BankC brightness to any allowable brightness code (0 to 7)



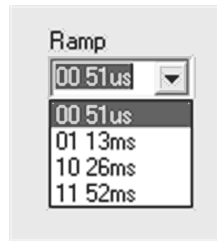


Figure 18. BankA Ramp Step Time

- Ramp Step Time: This field sets the BankA brightness control ramp-up/ramp-down times. The time shown in the field corresponds to the time the LM2756 remains at each brightness code.

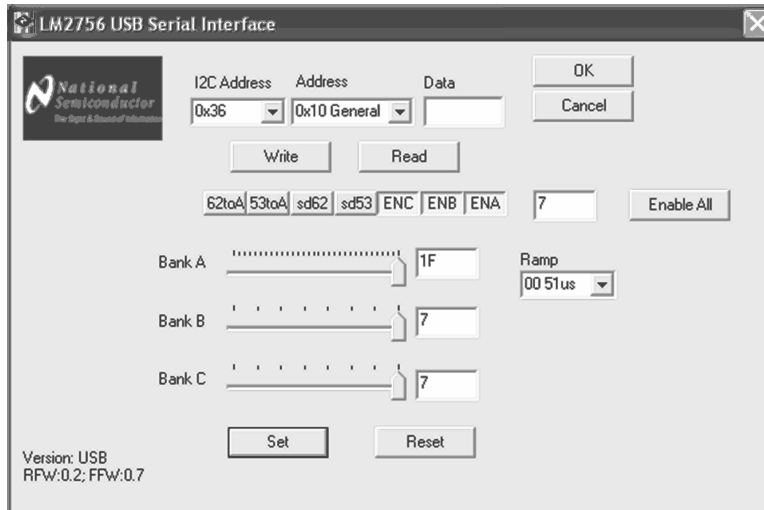


Figure 19. Results of Pressing the Set Button

Pressing the Set button places the LM2756 into the 4:3:1 configuration and sets the brightness levels in each bank to full-scale.

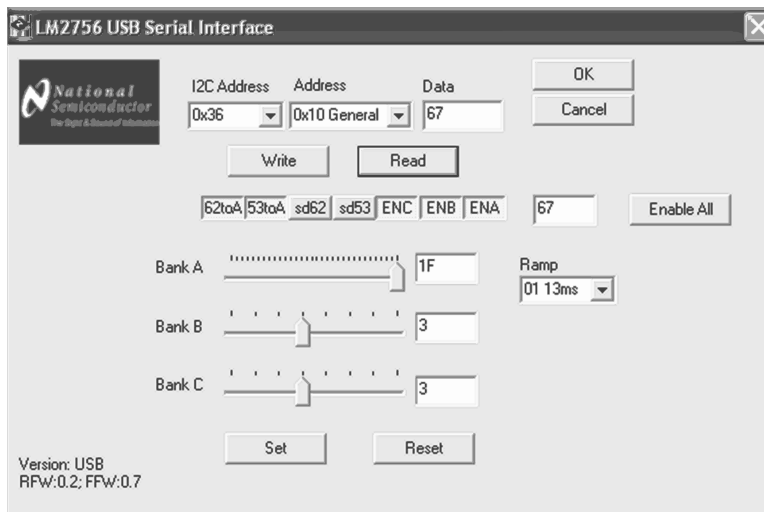


Figure 20. Example Configuration

In this configuration, the LM2756 will have 6 LEDs in BankA set to the full-scale brightness with a ramp step time equal to 13ms. BankB and BankC are each set to brightness code3 and are both active.

**NOTE:** If the part is enabled to any level of brightness or state and the program is closed (by either hitting the OK or cancel buttons) , the LM2756 part will remain in the last controlled state.

---

## IMPORTANT NOTICE

Texas Instruments Incorporated and its subsidiaries (TI) reserve the right to make corrections, enhancements, improvements and other changes to its semiconductor products and services per JESD46, latest issue, and to discontinue any product or service per JESD48, latest issue. Buyers should obtain the latest relevant information before placing orders and should verify that such information is current and complete. All semiconductor products (also referred to herein as "components") are sold subject to TI's terms and conditions of sale supplied at the time of order acknowledgment.

TI warrants performance of its components to the specifications applicable at the time of sale, in accordance with the warranty in TI's terms and conditions of sale of semiconductor products. Testing and other quality control techniques are used to the extent TI deems necessary to support this warranty. Except where mandated by applicable law, testing of all parameters of each component is not necessarily performed.

TI assumes no liability for applications assistance or the design of Buyers' products. Buyers are responsible for their products and applications using TI components. To minimize the risks associated with Buyers' products and applications, Buyers should provide adequate design and operating safeguards.

TI does not warrant or represent that any license, either express or implied, is granted under any patent right, copyright, mask work right, or other intellectual property right relating to any combination, machine, or process in which TI components or services are used. Information published by TI regarding third-party products or services does not constitute a license to use such products or services or a warranty or endorsement thereof. Use of such information may require a license from a third party under the patents or other intellectual property of the third party, or a license from TI under the patents or other intellectual property of TI.

Reproduction of significant portions of TI information in TI data books or data sheets is permissible only if reproduction is without alteration and is accompanied by all associated warranties, conditions, limitations, and notices. TI is not responsible or liable for such altered documentation. Information of third parties may be subject to additional restrictions.

Resale of TI components or services with statements different from or beyond the parameters stated by TI for that component or service voids all express and any implied warranties for the associated TI component or service and is an unfair and deceptive business practice. TI is not responsible or liable for any such statements.

Buyer acknowledges and agrees that it is solely responsible for compliance with all legal, regulatory and safety-related requirements concerning its products, and any use of TI components in its applications, notwithstanding any applications-related information or support that may be provided by TI. Buyer represents and agrees that it has all the necessary expertise to create and implement safeguards which anticipate dangerous consequences of failures, monitor failures and their consequences, lessen the likelihood of failures that might cause harm and take appropriate remedial actions. Buyer will fully indemnify TI and its representatives against any damages arising out of the use of any TI components in safety-critical applications.

In some cases, TI components may be promoted specifically to facilitate safety-related applications. With such components, TI's goal is to help enable customers to design and create their own end-product solutions that meet applicable functional safety standards and requirements. Nonetheless, such components are subject to these terms.

No TI components are authorized for use in FDA Class III (or similar life-critical medical equipment) unless authorized officers of the parties have executed a special agreement specifically governing such use.

Only those TI components which TI has specifically designated as military grade or "enhanced plastic" are designed and intended for use in military/aerospace applications or environments. Buyer acknowledges and agrees that any military or aerospace use of TI components which have **not** been so designated is solely at the Buyer's risk, and that Buyer is solely responsible for compliance with all legal and regulatory requirements in connection with such use.

TI has specifically designated certain components as meeting ISO/TS16949 requirements, mainly for automotive use. In any case of use of non-designated products, TI will not be responsible for any failure to meet ISO/TS16949.

### Products

Audio	<a href="http://www.ti.com/audio">www.ti.com/audio</a>
Amplifiers	<a href="http://amplifier.ti.com">amplifier.ti.com</a>
Data Converters	<a href="http://dataconverter.ti.com">dataconverter.ti.com</a>
DLP® Products	<a href="http://www.dlp.com">www.dlp.com</a>
DSP	<a href="http://dsp.ti.com">dsp.ti.com</a>
Clocks and Timers	<a href="http://www.ti.com/clocks">www.ti.com/clocks</a>
Interface	<a href="http://interface.ti.com">interface.ti.com</a>
Logic	<a href="http://logic.ti.com">logic.ti.com</a>
Power Mgmt	<a href="http://power.ti.com">power.ti.com</a>
Microcontrollers	<a href="http://microcontroller.ti.com">microcontroller.ti.com</a>
RFID	<a href="http://www.ti-rfid.com">www.ti-rfid.com</a>
OMAP Applications Processors	<a href="http://www.ti.com/omap">www.ti.com/omap</a>
Wireless Connectivity	<a href="http://www.ti.com/wirelessconnectivity">www.ti.com/wirelessconnectivity</a>

### Applications

Automotive and Transportation	<a href="http://www.ti.com/automotive">www.ti.com/automotive</a>
Communications and Telecom	<a href="http://www.ti.com/communications">www.ti.com/communications</a>
Computers and Peripherals	<a href="http://www.ti.com/computers">www.ti.com/computers</a>
Consumer Electronics	<a href="http://www.ti.com/consumer-apps">www.ti.com/consumer-apps</a>
Energy and Lighting	<a href="http://www.ti.com/energy">www.ti.com/energy</a>
Industrial	<a href="http://www.ti.com/industrial">www.ti.com/industrial</a>
Medical	<a href="http://www.ti.com/medical">www.ti.com/medical</a>
Security	<a href="http://www.ti.com/security">www.ti.com/security</a>
Space, Avionics and Defense	<a href="http://www.ti.com/space-avionics-defense">www.ti.com/space-avionics-defense</a>
Video and Imaging	<a href="http://www.ti.com/video">www.ti.com/video</a>

### TI E2E Community

[e2e.ti.com](http://e2e.ti.com)