

Features

- $BV_{CEO} > 60V$
- $I_C = 3A$ Continuous Collector Current
- $I_{CM} = 8A$ Peak Pulse Current
- $R_{CE(SAT)} < 90m\Omega$
- Rated to +175°C – Ideal for High Ambient Temperature Environments
- **Lead-Free Finish; RoHS Compliant (Notes 1 & 2)**
- **Halogen and Antimony Free. "Green" Device (Note 3)**
- **An Automotive-Compliant Part is Available Under Separate Datasheet ([DXTN3C60PSQ](#))**

Mechanical Data

- Case: PowerDI[®] 5060-8
- Case Material: Molded Plastic, "Green" Molding Compound. UL Flammability Classification Rating 94V-0
- Moisture Sensitivity: Level 1 per J-STD-020
- Terminal Finish - Matte Tin Annealed over Copper Leadframe; Solderable per MIL-STD-202, Method 208 ^(e3)
- Weight: 0.097 grams (Approximate)

Applications

- Power Management
- Load Switch
- Linear Mode Voltage Regulator
- Backlighting Applications

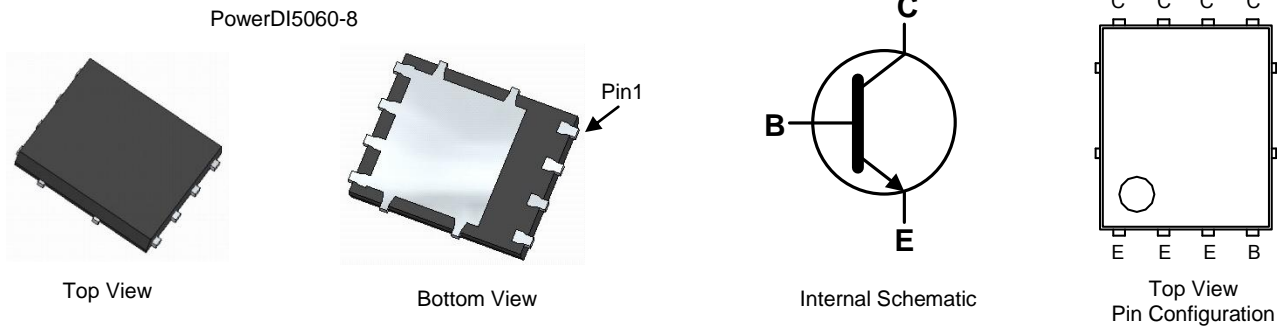

Ordering Information (Note 4)

Part Number	Compliance	Marking	Reel Size (inches)	Tape Width (mm)	Quantity Per Reel
DXTN3C60PS-13	AEC-Q101	DXTN3C60PS	13	12	1,000

- Notes:
1. EU Directive 2002/95/EC (RoHS), 2011/65/EU (RoHS 2) & 2015/863/EU (RoHS 3) compliant. All applicable RoHS exemptions applied.
 2. See <https://www.diodes.com/quality/lead-free/> for more information about Diodes Incorporated's definitions of Halogen- and Antimony-free, "Green" and Lead-free.
 3. Halogen- and Antimony-free "Green" products are defined as those which contain <900ppm bromine, <900ppm chlorine (<1500ppm total Br + Cl) and <1000ppm antimony compounds.
 4. For packaging details, go to our website at <https://www.diodes.com/design/support/packaging/diodes-packaging/>.

Marking Information

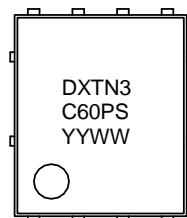

DXTN3 = Product Type Marking Code
 C60PS = Product Type Marking Code
 YYWW = Date Code Marking
 YY = Last Two Digits of Year (ex: 19 = 2019)
 WW = Week Code (01 to 53)

Absolute Maximum Ratings (@T_A = +25°C, unless otherwise specified.)

Characteristic	Symbol	Value	Unit
Collector-Base Voltage	V _{CBO}	60	V
Collector-Emitter Voltage	V _{CEO}	60	V
Emitter-Base Voltage	V _{EBO}	7	V
Base Current	I _B	500	mA
Continuous Collector Current	I _C	3	A
Peak Pulse Collector Current	I _{CM}	8	A

Thermal Characteristics (@T_A = +25°C, unless otherwise specified.)

Characteristic	Symbol	Value	Unit
Power Dissipation (Note 5)	P _D	2.5	W
Thermal Resistance, Junction to Ambient (Note 5)	R _{θJA}	60	°C/W
		140 (Note 6)	
Thermal Resistance, Junction to Case (Note 5, 7)	R _{θJC}	2	°C/W
		12 (Note 6, 7)	
Operating and Storage Temperature Range	T _J , T _{STG}	-55 to +175	°C

ESD Ratings (Note 8)

Characteristic	Symbol	Value	Unit	JEDEC Class
Electrostatic Discharge - Human Body Model	ESD HBM	8000	V	3A
Electrostatic Discharge - Machine Model	ESD MM	400	V	C

- Notes:
5. For a device mounted with the collector lead on 25mm x 25mm 2oz copper that is on a single-sided 1.6mm FR4 PCB; device is measured under still air conditions whilst operating in a steady-state.
 6. Same as note (5), except mounted on minimum recommended pad layout.
 7. Thermal resistance from junction to the top of the case.
 8. Refer to JEDEC specification JESD22-A114 and JESD22-A115.

Typical Thermal Characteristics (@ $T_A = +25^\circ\text{C}$, unless otherwise specified.)

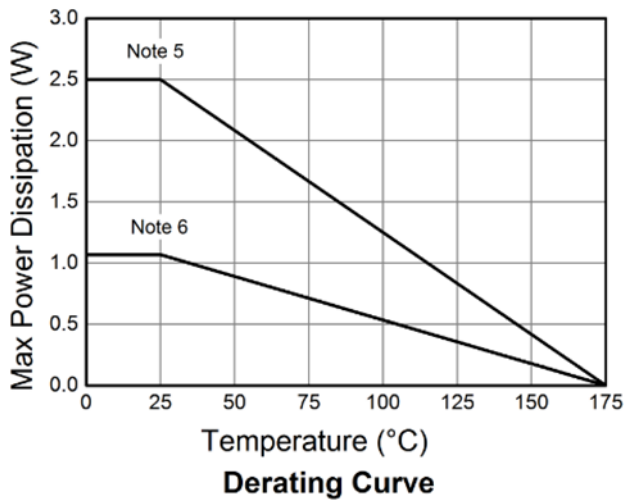
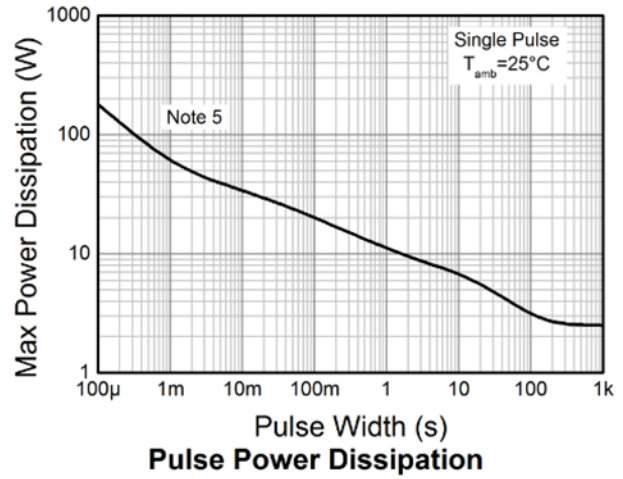
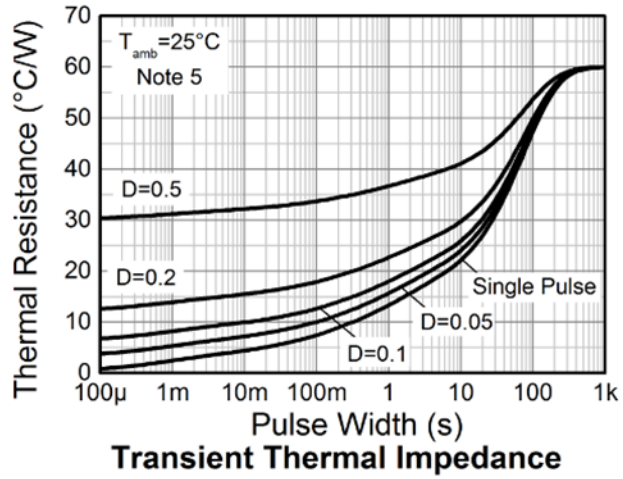
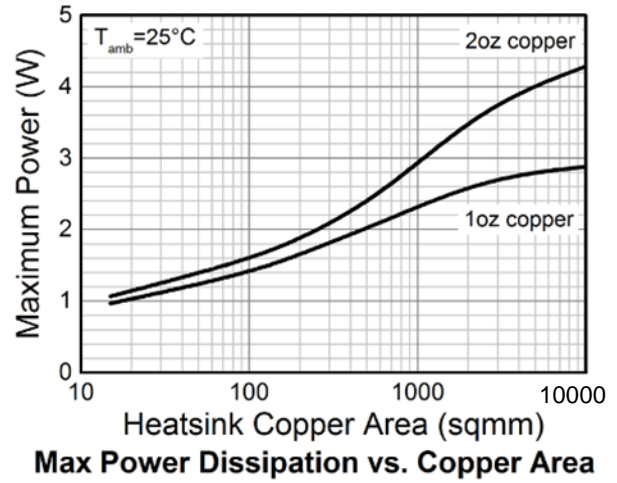
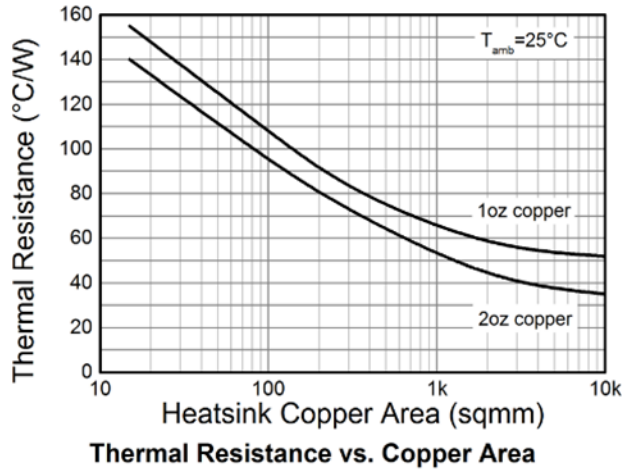

Electrical Characteristics (@T_A = +25°C, unless otherwise specified.)

Characteristic	Symbol	Min	Typ	Max	Unit	Test Condition
OFF CHARACTERISTICS						
Collector-Base Breakdown Voltage	BV _{CBO}	60	—	—	V	I _C = 100μA
Collector-Emitter Breakdown Voltage (Note 9)	BV _{CEO}	60	—	—	V	I _C = 10mA
Emitter-Base Breakdown Voltage	BV _{EBO}	7	—	—	V	I _E = 100μA
Collector-Base Cutoff Current	I _{CBO}	—	—	100	nA	V _{CB} = 48V
		—	—	50	μA	V _{CB} = 48V @T _J = +150°C
Emitter Cutoff Current	I _{EBO}	—	—	100	nA	V _{EB} = 7V
Collector-Emitter Cutoff Current	I _{CES}	—	—	100	nA	V _{CES} = 48V
ON CHARACTERISTICS (Note 9)						
DC Current Gain	h _{FE}	200	400	—	—	I _C = 500mA, V _{CE} = 2V
		200	330	—		I _C = 1A, V _{CE} = 2V
		100	180	—		I _C = 2A, V _{CE} = 2V
		50	100	—		I _C = 3A, V _{CE} = 2V
Collector-Emitter Saturation Voltage	V _{CE(SAT)}	—	70	120	mV	I _C = 1A, I _B = 50mA
		—	180	270	mV	I _C = 3A, I _B = 300mA
Collector-Emitter Saturation Resistance	R _{CE(SAT)}	—	60	90	mΩ	I _C = 3A, I _B = 300mA
Base-Emitter Saturation Voltage	V _{BE(SAT)}	—	0.86	1.0	V	I _C = 1A, I _B = 100mA
		—	1.0	1.2		I _C = 2A, I _B = 200mA
Base-Emitter Turn-On Voltage	V _{BE(ON)}	—	0.65	0.85	V	I _C = 0.1A, V _{CE} = 2V
SMALL SIGNAL CHARACTERISTICS						
Current Gain-Bandwidth Product	f _T	—	140	—	MHz	V _{CE} = 10V, I _C = 100mA, f = 10MHz
Output Capacitance	C _{obo}	—	17	—	pF	V _{CB} = 10V, f = 1MHz
Delay Time	t _D	—	15	—	ns	V _{CC} = 12.5V, I _C = 1A I _{B1} = -I _{B2} = 0.05A
Rise Time	t _R	—	120	—	ns	
Turn-On Time	t _(ON)	—	135	—	ns	
Storage Time	t _S	—	800	—	ns	
Fall Time	t _F	—	300	—	ns	
Turn-Off Time	t _(OFF)	—	1100	—	ns	

Note: 9. Measured under pulsed conditions. Pulse width ≤ 300μs. Duty cycle ≤ 2%.

Typical Electrical Characteristics (@ $T_A = +25^\circ\text{C}$, unless otherwise specified.)

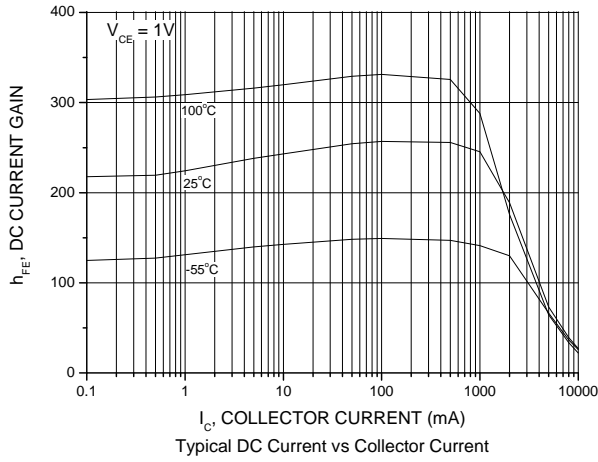

Typical DC Current vs Collector Current

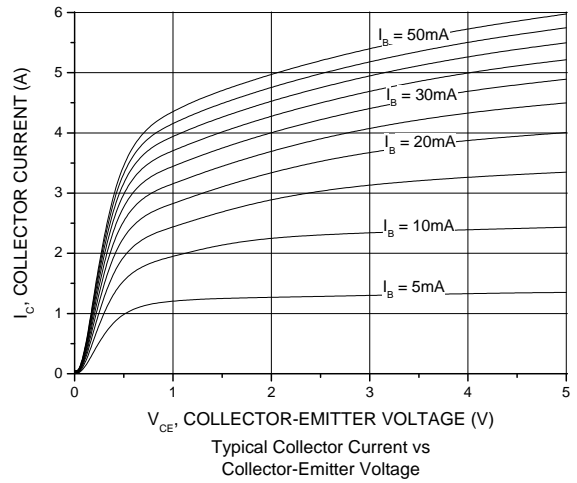

Typical Collector Current vs Collector-Emitter Voltage

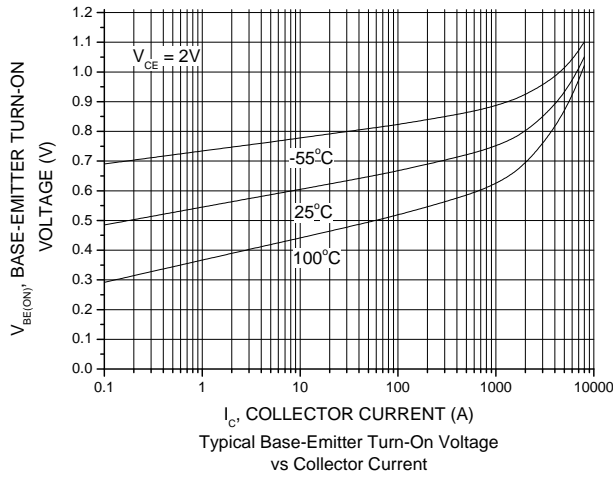

Typical Base-Emitter Turn-On Voltage vs Collector Current

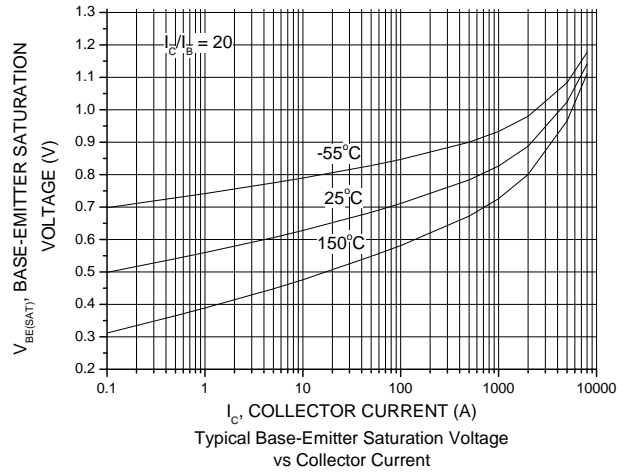

Typical Base-Emitter Saturation Voltage vs Collector Current

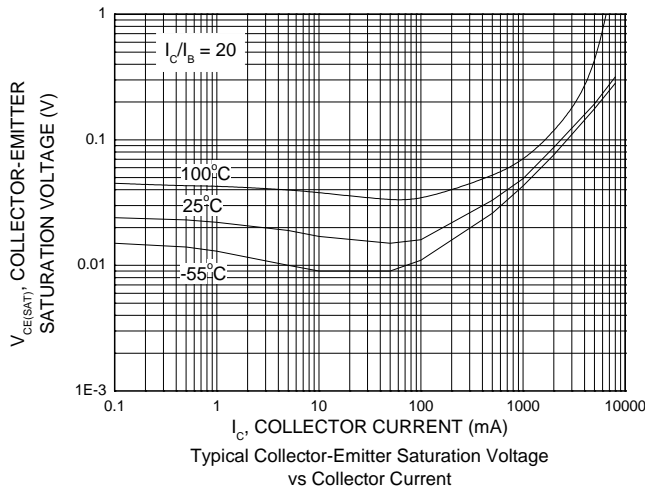

Typical Collector-Emitter Saturation Voltage vs Collector Current

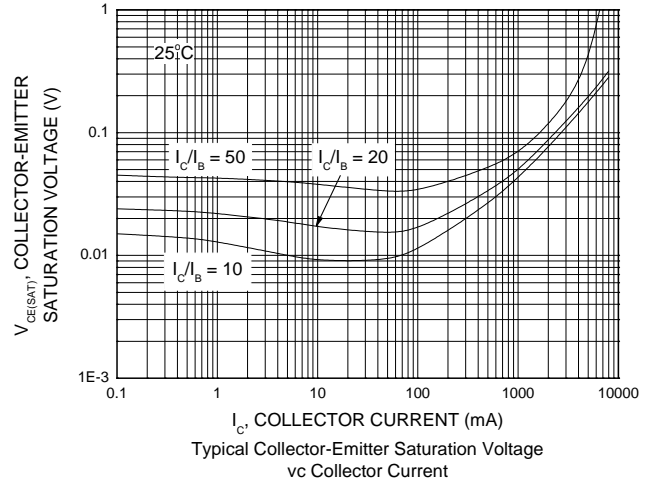

Typical Collector-Emitter Saturation Voltage vs Collector Current

Typical Electrical Characteristics (@T_A = +25°C, unless otherwise specified.) (continued)

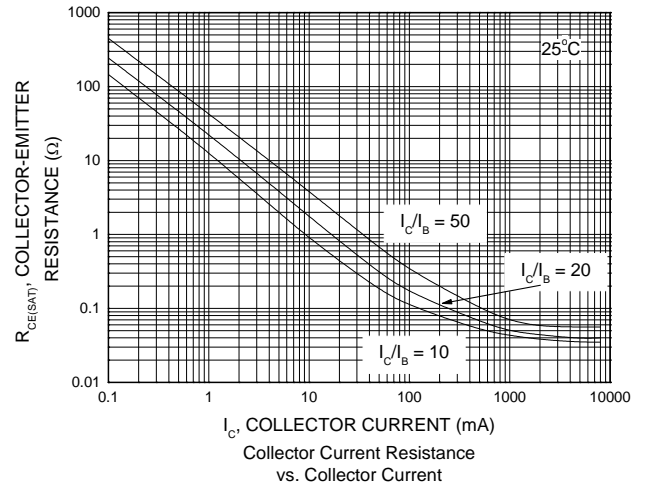
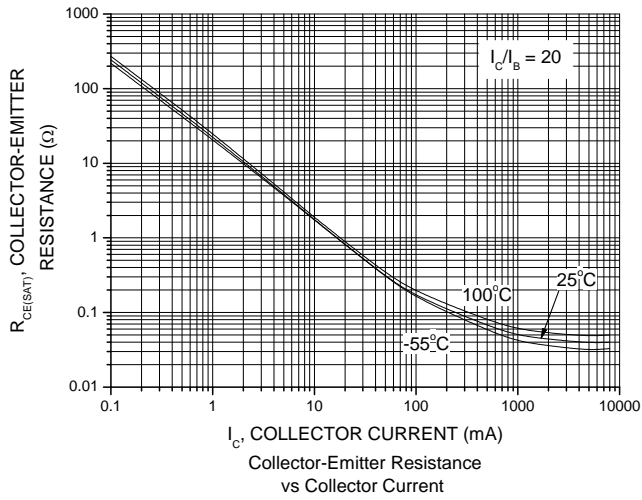

Package Outline Dimensions

Please see <http://www.diodes.com/package-outlines.html> for the latest version.

PowerDI5060-8

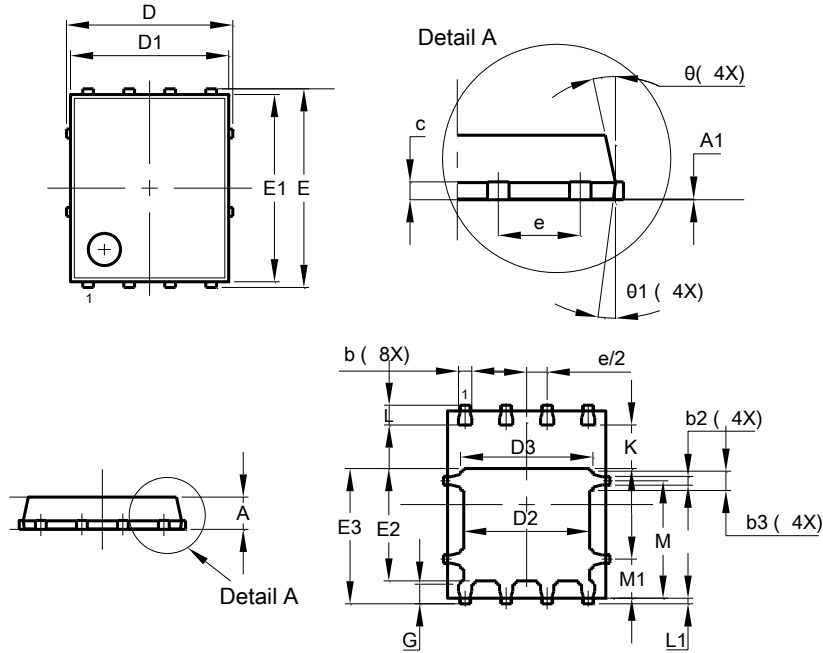

PowerDI5060-8			
Dim	Min	Max	Typ
A	0.90	1.10	1.00
A1	0.00	0.05	-
b	0.33	0.51	0.41
b2	0.200	0.350	0.273
b3	0.40	0.80	0.60
c	0.230	0.330	0.277
D	5.15 BSC		
D1	4.70	5.10	4.90
D2	3.70	4.10	3.90
D3	3.90	4.30	4.10
E	6.15 BSC		
E1	5.60	6.00	5.80
E2	3.28	3.68	3.48
E3	3.99	4.39	4.19
e	1.27 BSC		
G	0.51	0.71	0.61
K	0.51	-	-
L	0.51	0.71	0.61
L1	0.100	0.200	0.175
M	3.235	4.035	3.635
M1	1.00	1.40	1.21
θ	10°	12°	11°
θ1	6°	8°	7°
All Dimensions in mm			

Suggested Pad Layout

Please see <http://www.diodes.com/package-outlines.html> for the latest version.

PowerDI5060-8

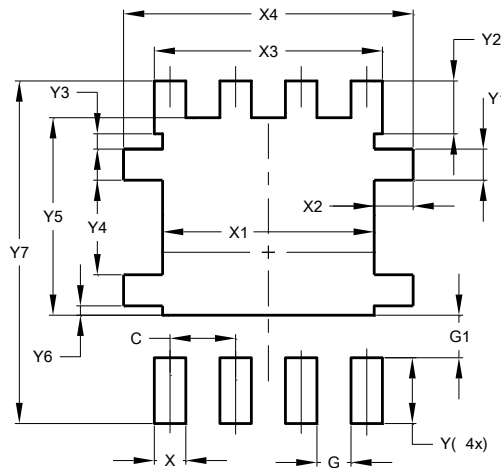

Dimensions	Value (in mm)
C	1.270
G	0.660
G1	0.820
X	0.610
X1	4.100
X2	0.755
X3	4.420
X4	5.610
Y	1.270
Y1	0.600
Y2	1.020
Y3	0.295
Y4	1.825
Y5	3.810
Y6	0.180
Y7	6.610

IMPORTANT NOTICE

DIODES INCORPORATED MAKES NO WARRANTY OF ANY KIND, EXPRESS OR IMPLIED, WITH REGARDS TO THIS DOCUMENT, INCLUDING, BUT NOT LIMITED TO, THE IMPLIED WARRANTIES OF MERCHANTABILITY AND FITNESS FOR A PARTICULAR PURPOSE (AND THEIR EQUIVALENTS UNDER THE LAWS OF ANY JURISDICTION).

Diodes Incorporated and its subsidiaries reserve the right to make modifications, enhancements, improvements, corrections or other changes without further notice to this document and any product described herein. Diodes Incorporated does not assume any liability arising out of the application or use of this document or any product described herein; neither does Diodes Incorporated convey any license under its patent or trademark rights, nor the rights of others. Any Customer or user of this document or products described herein in such applications shall assume all risks of such use and will agree to hold Diodes Incorporated and all the companies whose products are represented on Diodes Incorporated website, harmless against all damages.

Diodes Incorporated does not warrant or accept any liability whatsoever in respect of any products purchased through unauthorized sales channel. Should Customers purchase or use Diodes Incorporated products for any unintended or unauthorized application, Customers shall indemnify and hold Diodes Incorporated and its representatives harmless against all claims, damages, expenses, and attorney fees arising out of, directly or indirectly, any claim of personal injury or death associated with such unintended or unauthorized application.

Products described herein may be covered by one or more United States, international or foreign patents pending. Product names and markings noted herein may also be covered by one or more United States, international or foreign trademarks.

This document is written in English but may be translated into multiple languages for reference. Only the English version of this document is the final and determinative format released by Diodes Incorporated.

LIFE SUPPORT

Diodes Incorporated products are specifically not authorized for use as critical components in life support devices or systems without the express written approval of the Chief Executive Officer of Diodes Incorporated. As used herein:

A. Life support devices or systems are devices or systems which:

1. are intended to implant into the body, or
2. support or sustain life and whose failure to perform when properly used in accordance with instructions for use provided in the labeling can be reasonably expected to result in significant injury to the user.

B. A critical component is any component in a life support device or system whose failure to perform can be reasonably expected to cause the failure of the life support device or to affect its safety or effectiveness.

Customers represent that they have all necessary expertise in the safety and regulatory ramifications of their life support devices or systems, and acknowledge and agree that they are solely responsible for all legal, regulatory and safety-related requirements concerning their products and any use of Diodes Incorporated products in such safety-critical, life support devices or systems, notwithstanding any devices- or systems-related information or support that may be provided by Diodes Incorporated. Further, Customers must fully indemnify Diodes Incorporated and its representatives against any damages arising out of the use of Diodes Incorporated products in such safety-critical, life support devices or systems.

Copyright © 2019, Diodes Incorporated

www.diodes.com