

PART NAME	NEMA 4X ENCLOSURE	PART No.	PNR-2605, PNR-2605-C AND PNR-2605-DG PNR-2606, PNR-2606-C AND PNR-2606-DG	REV. DATE	11-17-08
-----------	-------------------	----------	--	-----------	----------

INDUSTRY STANDARDS:
 POLYCARBONATE (LIGHT GRAY AND CLEAR)
 UL94-HB FLAMMABILITY RATING (UL FILE #E41613)
 UV STABILIZED
 SERVICE TEMPERATURE RANGE: -40°C TO +120°C
 ABS (DARK GRAY)
 UL94-HB FLAMMABILITY RATING (UL FILE #E56070)
 SERVICE TEMPERATURE RANGE: -40°C TO +80°C

PART NUMBER	DIMENSION			
	A	B	C	D
PNR-2605, PNR-2605-C AND PNR-2605-DG	1.442	1.382	2.377	1.926
PNR-2606, PNR-2606-C AND PNR-2606-DG	3.022	2.962	3.957	3.506

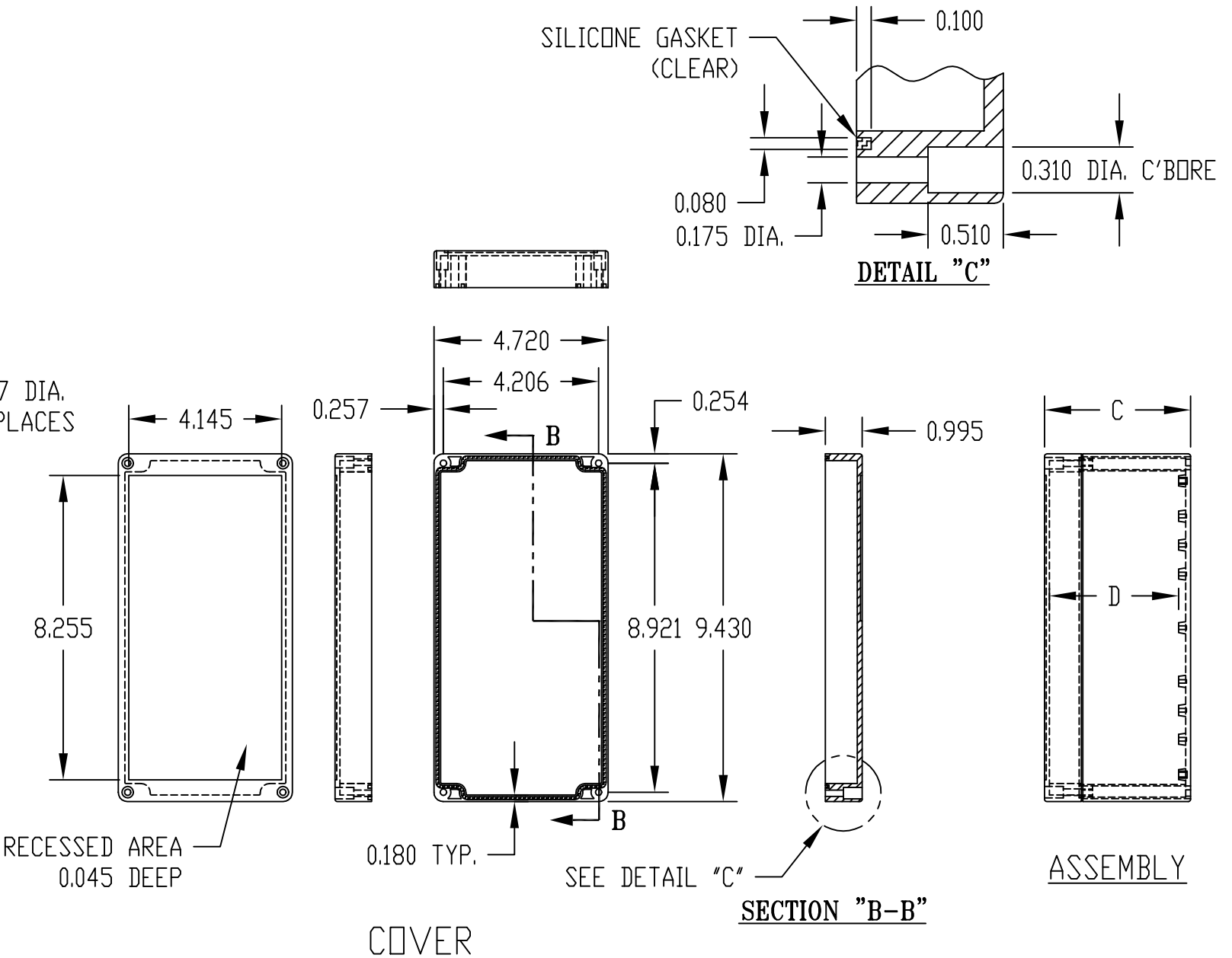
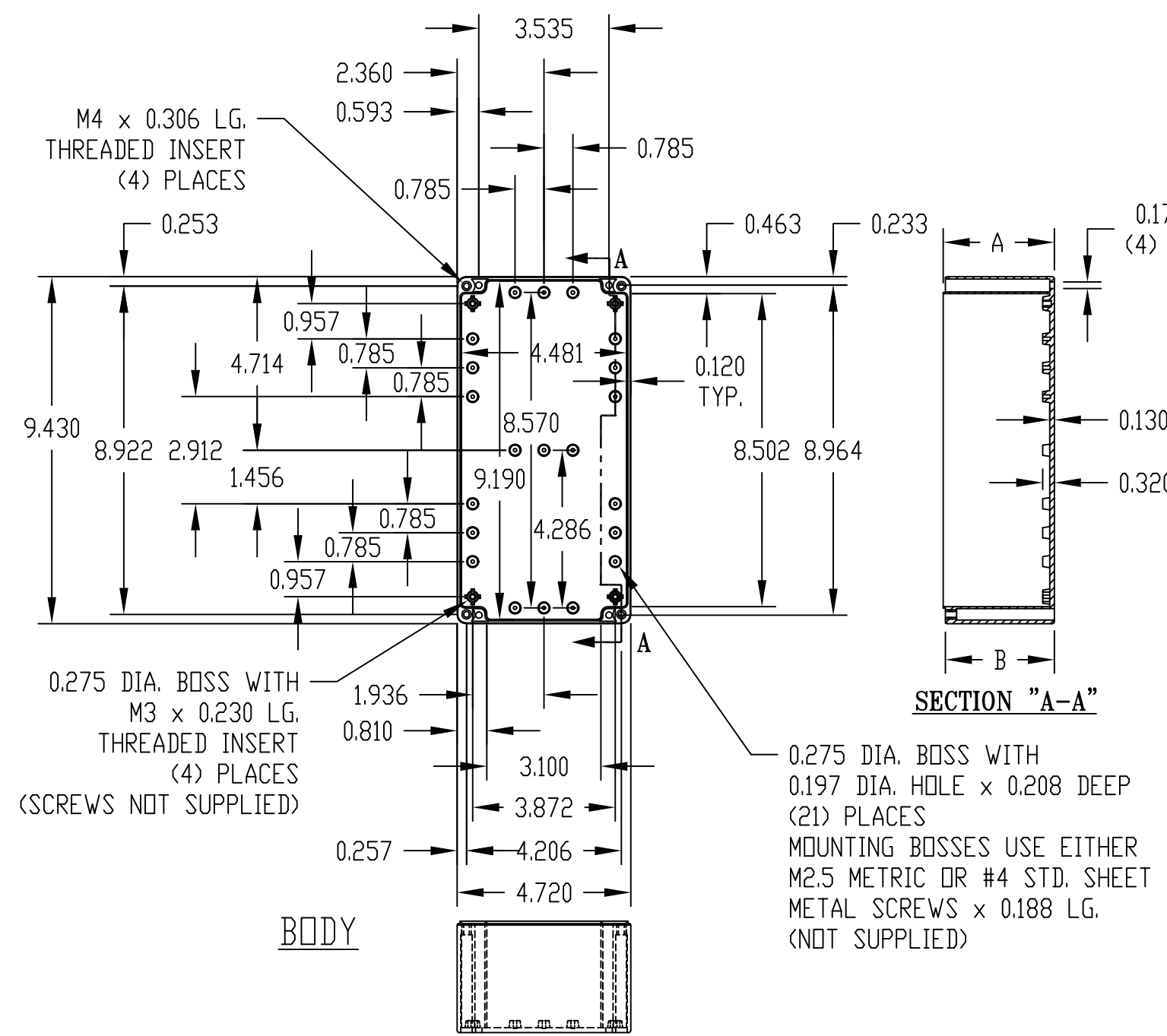

NOTE: ALL DIMENSIONS HAVE ±0.015 TOLERANCE UNLESS OTHERWISE SPECIFIED.

PART NUMBER	MATERIAL		FINISH		HARDWARE KIT
	BODY	COVER	BODY	COVER	
PNR-2605 & PNR-2606	POLYCARBONATE		LIGHT GRAY		KIT CONTAINS (4) M4 x 17mm (0.668") LG. SCREWS FOR ASSEMBLY
PNR-2605-C & PNR-2606-C	POLYCARBONATE		LIGHT GRAY	CLEAR	
PNR-2605-DG & PNR-2606-DG	HIGH-IMPACT ABS		DARK GRAY		