

IRGP30B60KD-EP

INSULATED GATE BIPOLAR TRANSISTOR WITH ULTRAFAST SOFT RECOVERY DIODE

Features

- Low $V_{CE(on)}$ Non Punch Through IGBT Technology.
- Low Diode V_F .
- 10 μ s Short Circuit Capability.
- Square RBSOA.
- Ultrasoft Diode Reverse Recovery Characteristics.
- Positive $V_{CE(on)}$ Temperature Coefficient.
- TO-247AD Package
- Lead-Free

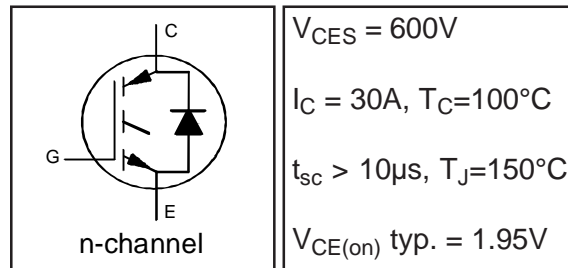

Benefits

- Benchmark Efficiency for Motor Control.
- Rugged Transient Performance.
- Low EMI.
- Excellent Current Sharing in Parallel Operation.

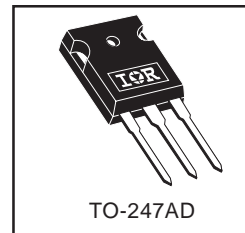

Absolute Maximum Ratings

	Parameter	Max.	Units
V_{CES}	Collector-to-Emitter Voltage	600	V
$I_C @ T_C = 25^\circ C$	Continuous Collector Current	60	A
$I_C @ T_C = 100^\circ C$	Continuous Collector Current	30	
I_{CM}	Pulsed Collector Current	120	
I_{LM}	Clamped Inductive Load Current ①	120	
$I_F @ T_C = 25^\circ C$	Diode Continuous Forward Current	60	
$I_F @ T_C = 100^\circ C$	Diode Continuous Forward Current	30	
I_{FM}	Diode Maximum Forward Current	120	
V_{GE}	Gate-to-Emitter Voltage	± 20	V
$P_D @ T_C = 25^\circ C$	Maximum Power Dissipation	304	W
$P_D @ T_C = 100^\circ C$	Maximum Power Dissipation	122	
T_J	Operating Junction and	-55 to +150	$^\circ C$
T_{STG}	Storage Temperature Range		
	Soldering Temperature, for 10 sec.		
	Mounting Torque, 6-32 or M3 Screw	10 lbf•in (1.1N•m)	

Thermal Resistance

	Parameter	Min.	Typ.	Max.	Units
$R_{\theta JC}$	Junction-to-Case - IGBT	—	—	0.41	$^\circ C/W$
$R_{\theta JC}$	Junction-to-Case - Diode	—	—	1.32	
$R_{\theta CS}$	Case-to-Sink, flat, greased surface	—	0.24	—	
$R_{\theta JA}$	Junction-to-Ambient, typical socket mount	—	—	40	
Wt	Weight	—	6.0	—	

IRGP30B60KD-EP

International
IR Rectifier

Electrical Characteristics @ T_J = 25°C (unless otherwise specified)

	Parameter	Min.	Typ.	Max.	Units	Conditions	Ref.Fig.
V _{(BR)CES}	Collector-to-Emitter Breakdown Voltage	600	—	—	V	V _{GE} = 0V, I _C = 500μA	
ΔV _{(BR)CES} /ΔT _J	Temperature Coeff. of Breakdown Voltage	—	0.4	—	V/°C	V _{GE} = 0V, I _C = 1.0mA, (25°C-150°C)	
V _{CE(on)}	Collector-to-Emitter Saturation Voltage	—	1.95	2.35	V	I _C = 30A, V _{GE} = 15V	5,6,7
		—	2.40	2.75		I _C = 30A, V _{GE} = 15V, T _J = 150°C	9,10,11
V _{GE(th)}	Gate Threshold Voltage	3.5	4.5	5.5	V	V _{CE} = V _{GE} , I _C = 250μA	9,10,11
ΔV _{GE(th)} /ΔT _J	Temperature Coeff. of Threshold Voltage	—	-10	—	mV/°C	V _{CE} = V _{GE} , I _C = 1.0mA, (25°C-150°C)	12
g _{fe}	Forward Transconductance	—	18	—	S	V _{CE} = 50V, I _C = 50A, PW=80μs	
I _{CES}	Zero Gate Voltage Collector Current	—	5.0	250	μA	V _{GE} = 0V, V _{CE} = 600V	
		—	1000	2000		V _{GE} = 0V, V _{CE} = 600V, T _J = 150°C	
V _{FM}	Diode Forward Voltage Drop	—	1.30	1.55	V	I _F = 30A	8
		—	1.25	1.50		I _F = 30A T _J = 150°C	
I _{GES}	Gate-to-Emitter Leakage Current	—	—	±100	nA	V _{GE} = ±20V	

Switching Characteristics @ T_J = 25°C (unless otherwise specified)

	Parameter	Min.	Typ.	Max.	Units	Conditions	Ref.Fig.
Q _g	Total Gate Charge (turn-on)	—	102	153	nC	I _C = 30A	23
Q _{ge}	Gate - Emitter Charge (turn-on)	—	14	21		V _{CC} = 400V	CT.1
Q _{gc}	Gate - Collector Charge (turn-on)	—	44	66		V _{GE} = 15V	
E _{on}	Turn-On Switching Loss	—	350	620	μJ	I _C = 30A, V _{CC} = 400V	CT.4
E _{off}	Turn-Off Switching Loss	—	825	955		V _{GE} = 15V, R _G = 10Ω, L = 200μH,	
E _{tot}	Total Switching Loss	—	1175	1575		L _S = 150nH T _J = 25°C ②	
t _{d(on)}	Turn-On Delay Time	—	46	60	ns	I _C = 30A, V _{CC} = 400V	CT.4
t _r	Rise Time	—	28	39		V _{GE} = 15V, R _G = 10Ω L = 200μH	
t _{d(off)}	Turn-Off Delay Time	—	185	200		L _S = 150nH, T _J = 25°C	
t _f	Fall Time	—	31	40			
E _{on}	Turn-On Switching Loss	—	635	1085	μJ	I _C = 30A, V _{CC} = 400V	CT.4
E _{off}	Turn-Off Switching Loss	—	1150	1350		V _{GE} = 15V, R _G = 10Ω, L = 200μH	
E _{tot}	Total Switching Loss	—	1785	2435		L _S = 150nH T _J = 150°C ②	
t _{d(on)}	Turn-On Delay Time	—	46	60	ns	I _C = 30A, V _{CC} = 400V	CT.4
t _r	Rise Time	—	28	39		V _{GE} = 15V, R _G = 10Ω L = 200μH	
t _{d(off)}	Turn-Off Delay Time	—	205	235		L _S = 150nH, T _J = 150°C	
t _f	Fall Time	—	32	42			
C _{ies}	Input Capacitance	—	1750	—	pF	V _{GE} = 0V	22
C _{oes}	Output Capacitance	—	160	—		V _{CC} = 30V	
C _{res}	Reverse Transfer Capacitance	—	60	—		f = 1.0MHz	
RBSOA	Reverse Bias Safe Operating Area	FULL SQUARE				T _J = 150°C, I _C = 120A, V _p = 600V V _{CC} = 500V, V _{GE} = +15V to 0V, R _G = 10Ω	4 CT.2
SCSOA	Short Circuit Safe Operating Area	10	—	—	μs	T _J = 150°C, V _p = 600V, R _G = 10Ω V _{CC} = 360V, V _{GE} = +15V to 0V	CT.3 WF.4
E _{rec}	Reverse Recovery energy of the diode	—	925	1165	μJ	T _J = 150°C	17,18,19
t _{rr}	Diode Reverse Recovery time	—	125	—	ns	V _{CC} = 400V, I _F = 30A, L = 200μH	20,21
I _{rr}	Diode Peak Reverse Recovery Current	—	43	48	A	V _{GE} = 15V, R _G = 10Ω, L _S = 150nH	CT.4, WF.3

Notes: ① V_{CC} = 80% (V_{CES}), V_{GE} = 15V, L = 28μH, R_G = 22Ω.

② Energy losses include "tail" and diode reverse recovery.

IRGP30B60KD-EP

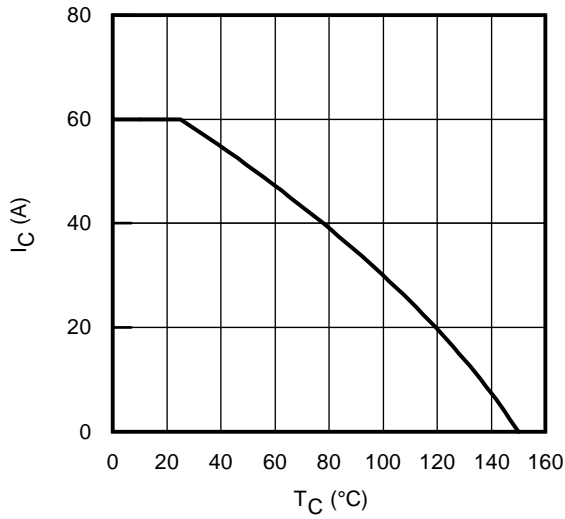

Fig. 1 - Maximum DC Collector Current vs. Case Temperature

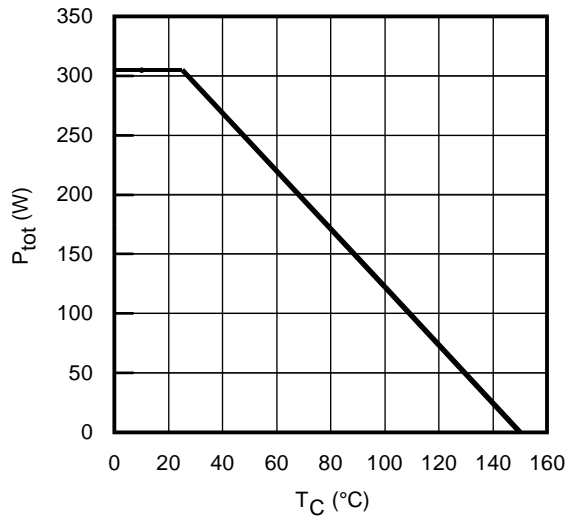

Fig. 2 - Power Dissipation vs. Case Temperature

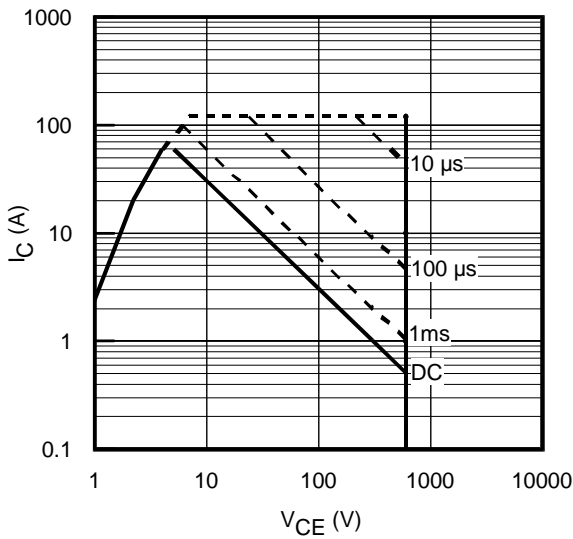

Fig. 3 - Forward SOA
 $T_C = 25^\circ\text{C}$; $T_J \leq 150^\circ\text{C}$

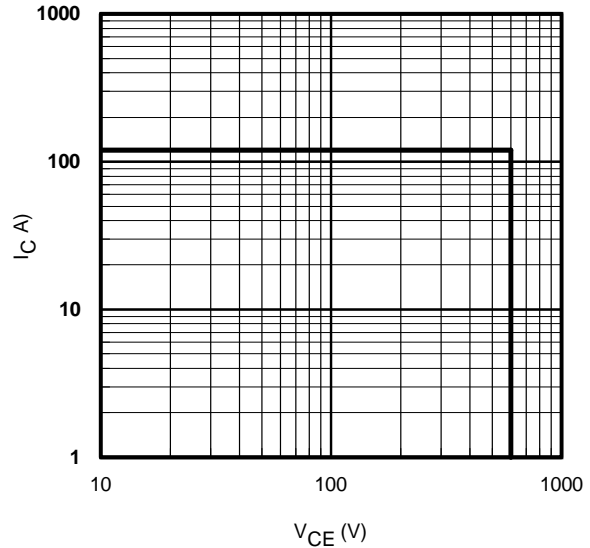

Fig. 4 - Reverse Bias SOA
 $T_J = 150^\circ\text{C}$; $V_{GE} = 15\text{V}$

IRGP30B60KD-EP

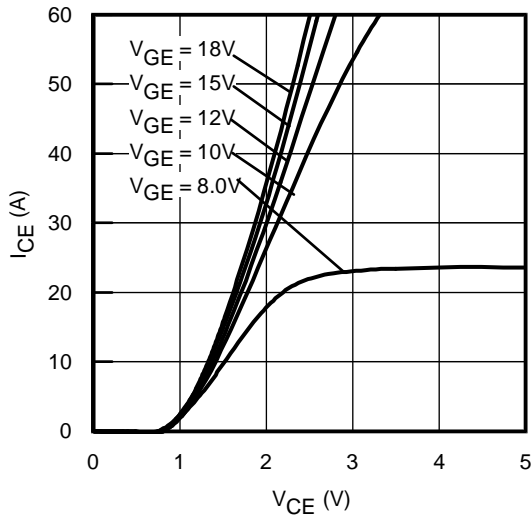

Fig. 5 - Typ. IGBT Output Characteristics
 $T_J = -40^{\circ}\text{C}$; $t_p = 80\mu\text{s}$

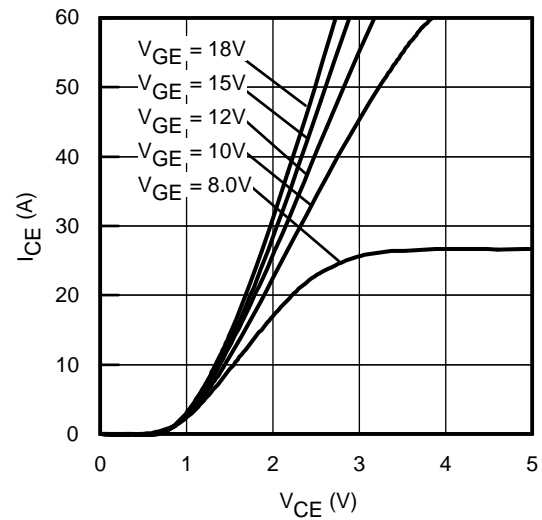

Fig. 6 - Typ. IGBT Output Characteristics
 $T_J = 25^{\circ}\text{C}$; $t_p = 80\mu\text{s}$

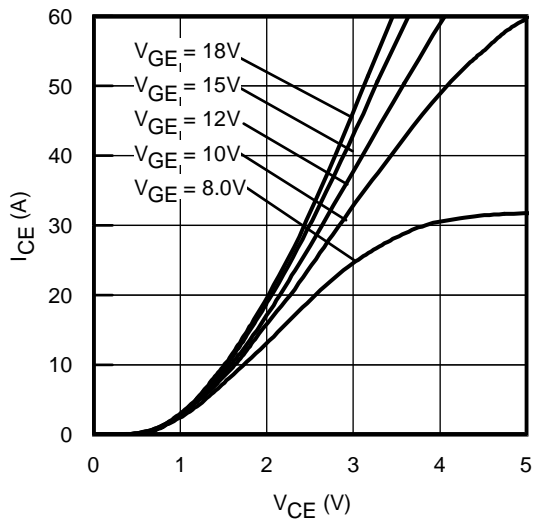

Fig. 7 - Typ. IGBT Output Characteristics
 $T_J = 150^{\circ}\text{C}$; $t_p = 80\mu\text{s}$

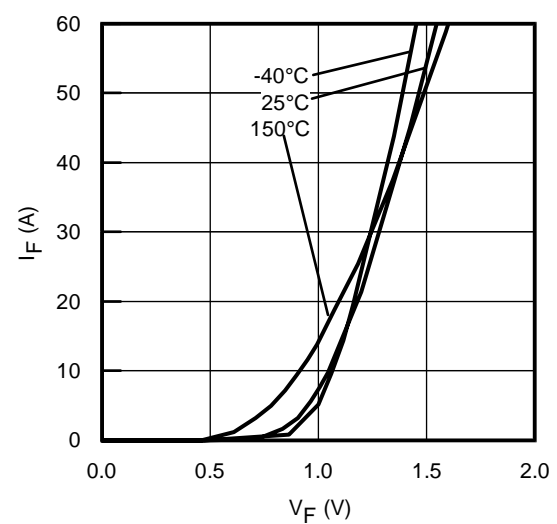

Fig. 8 - Typ. Diode Forward Characteristics
 $t_p = 80\mu\text{s}$

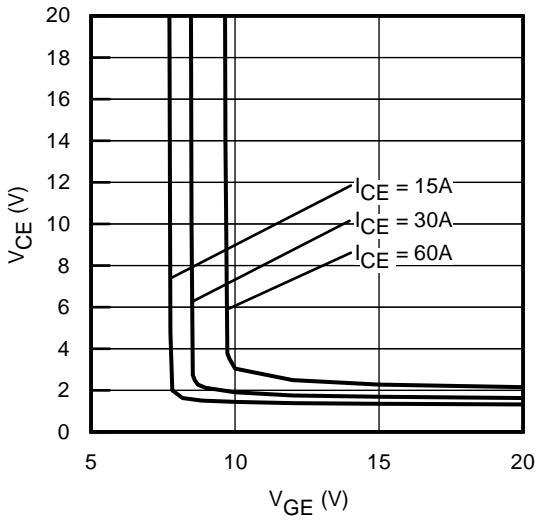

Fig. 9 - Typical V_{CE} vs. V_{GE}
 $T_J = -40^\circ\text{C}$

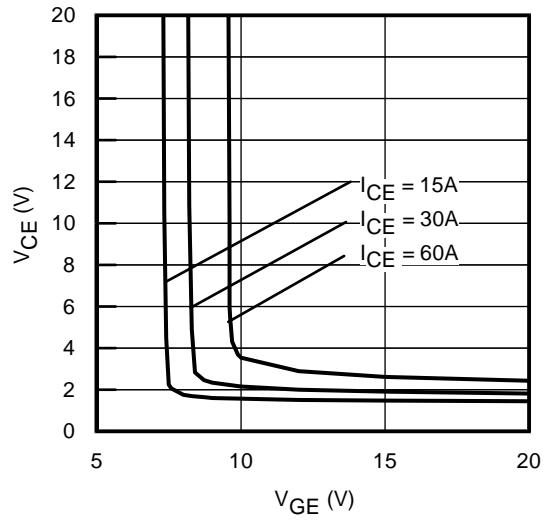

Fig. 10 - Typical V_{CE} vs. V_{GE}
 $T_J = 25^\circ\text{C}$

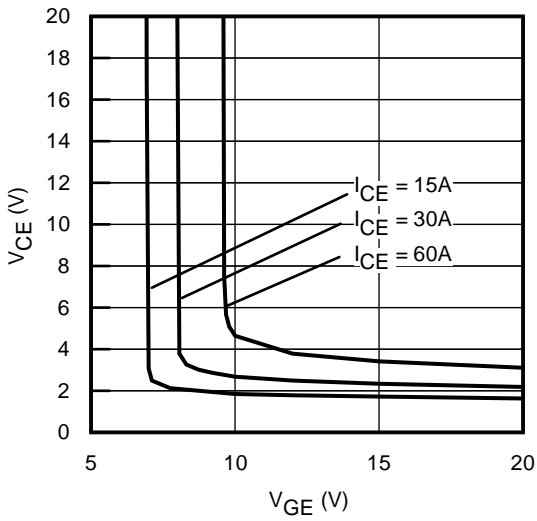

Fig. 11 - Typical V_{CE} vs. V_{GE}
 $T_J = 150^\circ\text{C}$

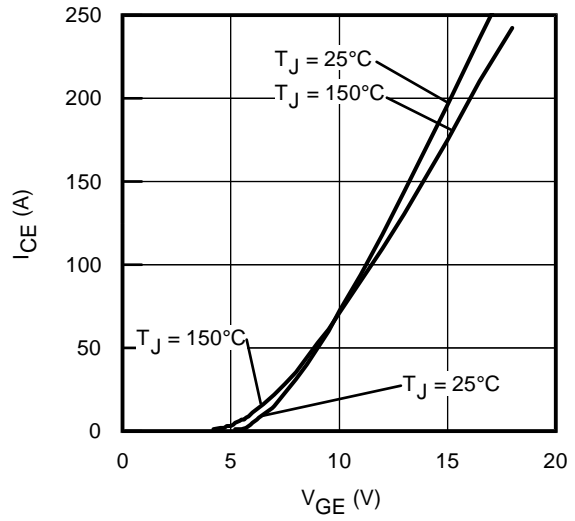

Fig. 12 - Typ. Transfer Characteristics
 $V_{CE} = 50\text{V}$; $t_p = 10\mu\text{s}$

IRGP30B60KD-EP

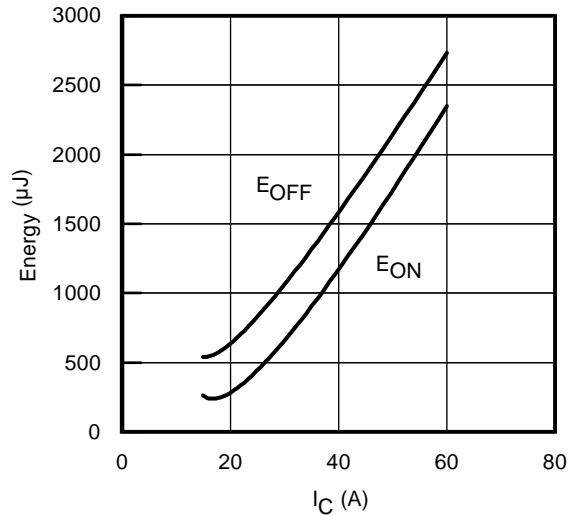

Fig. 13 - Typ. Energy Loss vs. I_C
 $T_J = 150^\circ\text{C}$; $L = 200\mu\text{H}$; $V_{CE} = 400\text{V}$
 $R_G = 10\Omega$; $V_{GE} = 15\text{V}$

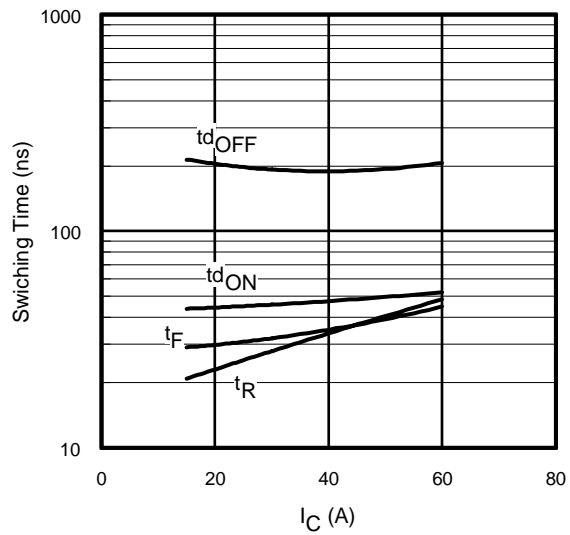

Fig. 14 - Typ. Switching Time vs. I_C
 $T_J = 150^\circ\text{C}$; $L = 200\mu\text{H}$; $V_{CE} = 400\text{V}$
 $R_G = 10\Omega$; $V_{GE} = 15\text{V}$

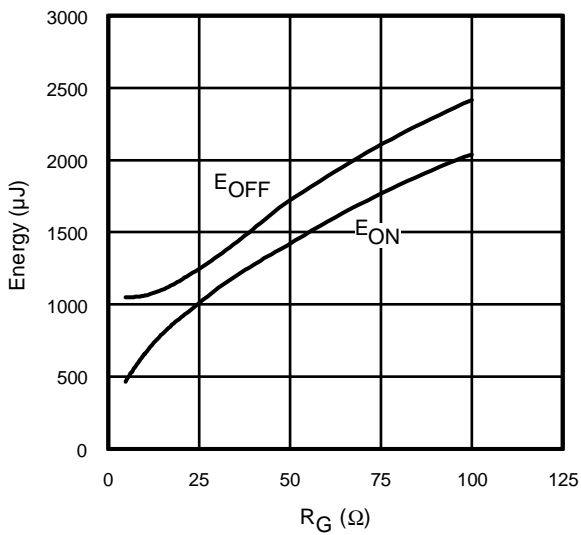

Fig. 15 - Typ. Energy Loss vs. R_G
 $T_J = 150^\circ\text{C}$; $L = 200\mu\text{H}$; $V_{CE} = 400\text{V}$
 $I_{CE} = 30\text{A}$; $V_{GE} = 15\text{V}$

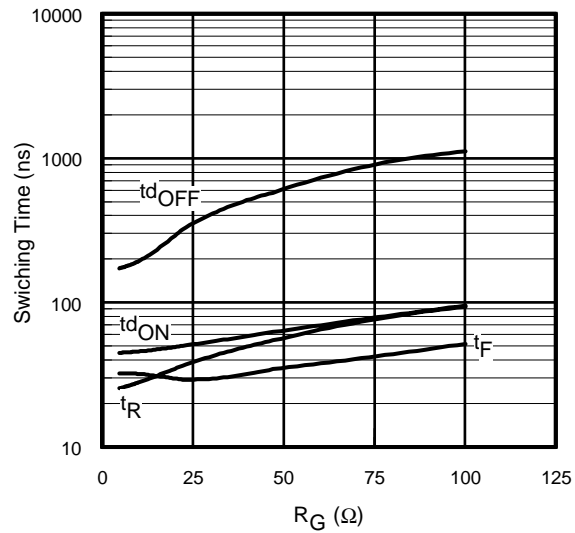

Fig. 16 - Typ. Switching Time vs. R_G
 $T_J = 150^\circ\text{C}$; $L = 200\mu\text{H}$; $V_{CE} = 400\text{V}$
 $I_{CE} = 30\text{A}$; $V_{GE} = 15\text{V}$

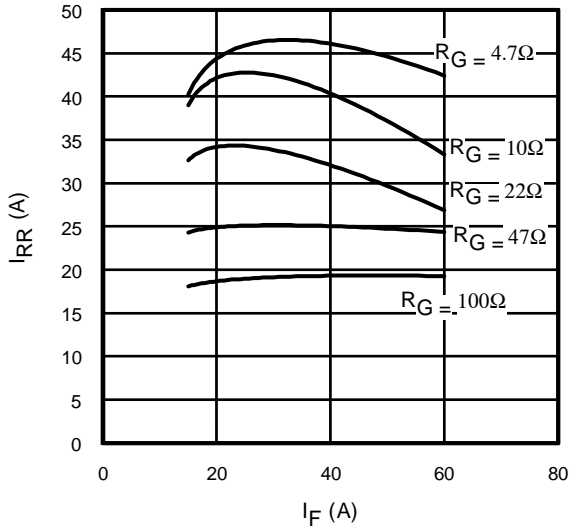

Fig. 17 - Typical Diode I_{RR} vs. I_F
 $T_J = 150^\circ\text{C}$

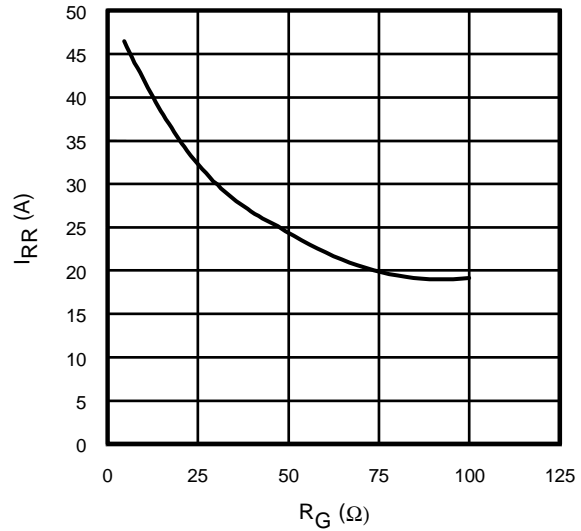

Fig. 18 - Typical Diode I_{RR} vs. R_G
 $T_J = 150^\circ\text{C}; I_F = 30\text{A}$

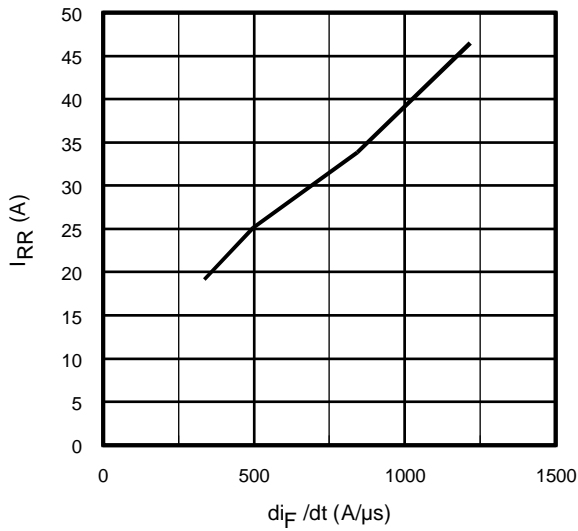

Fig. 19- Typical Diode I_{RR} vs. di_F/dt
 $V_{CC} = 400\text{V}; V_{GE} = 15\text{V};$
 $I_F = 30\text{A}; T_J = 150^\circ\text{C}$

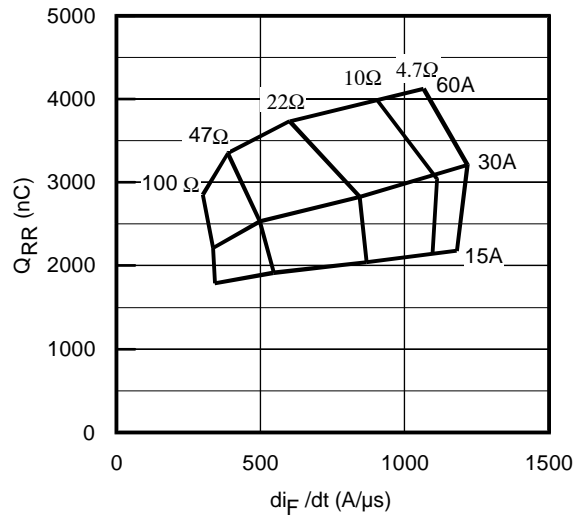

Fig. 20 - Typical Diode Q_{RR}
 $V_{CC} = 400\text{V}; V_{GE} = 15\text{V}; T_J = 150^\circ\text{C}$

IRGP30B60KD-EP

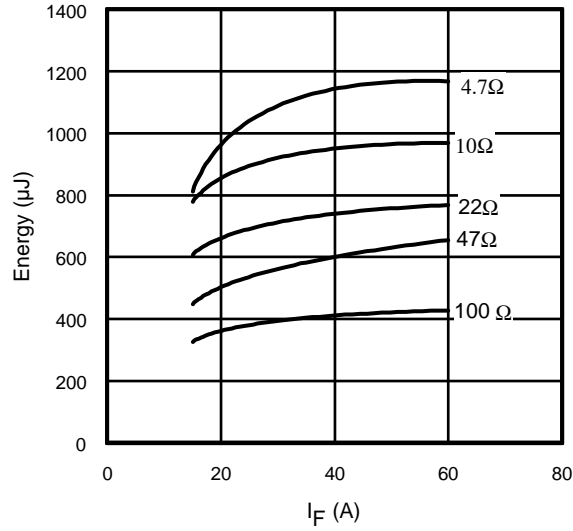

Fig. 21 - Typical Diode E_{RR} vs. I_F
 $T_J = 150^\circ\text{C}$

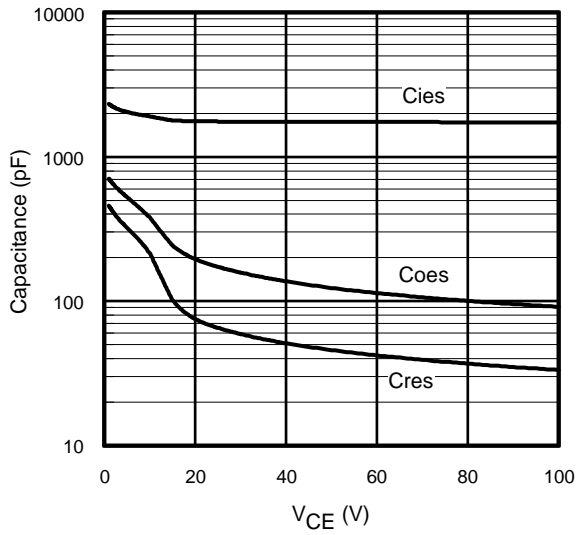

Fig. 22- Typ. Capacitance vs. V_{CE}
 $V_{GE} = 0\text{V}$; $f = 1\text{MHz}$

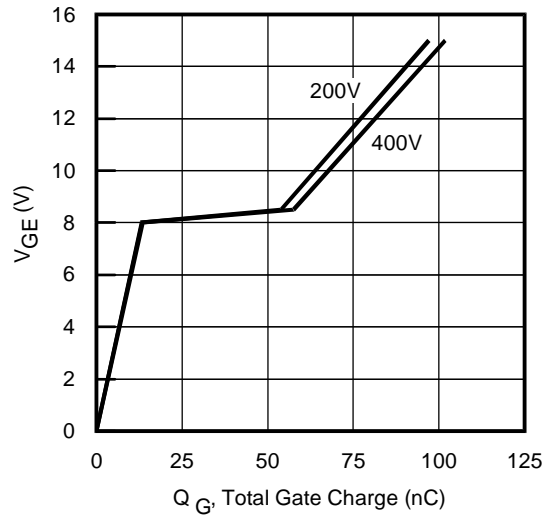

Fig. 23 - Typical Gate Charge vs. V_{GE}
 $I_{CE} = 30\text{A}$; $L = 600\mu\text{H}$

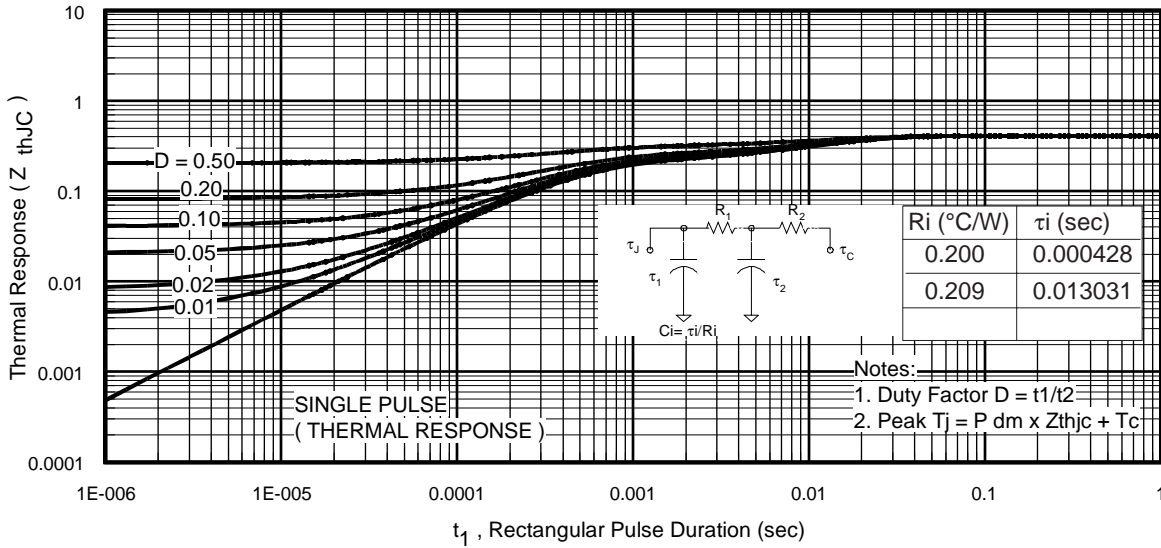

Fig 24. Maximum Transient Thermal Impedance, Junction-to-Case (IGBT)

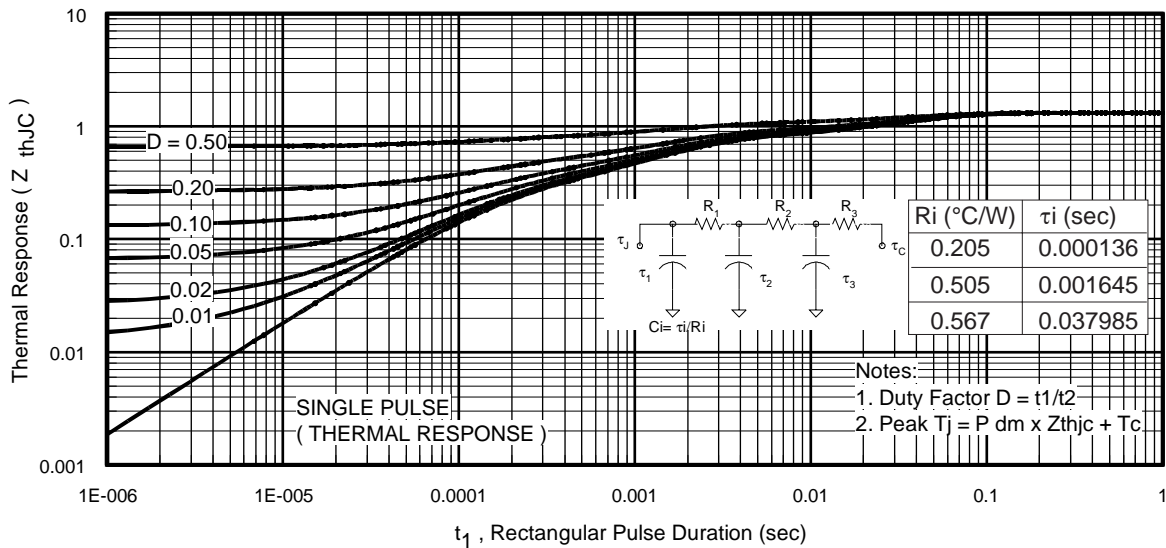

Fig 25. Maximum Transient Thermal Impedance, Junction-to-Case (DIODE)

IRGP30B60KD-EP

International
IR Rectifier

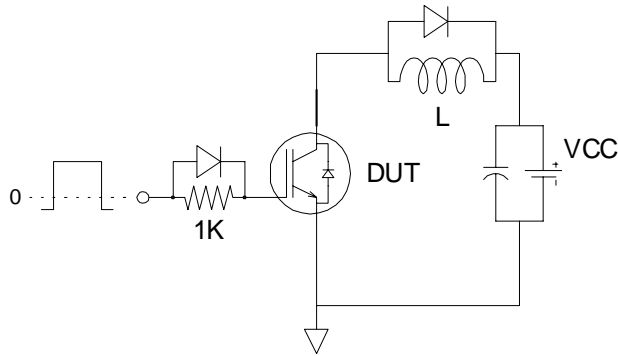

Fig.C.T.1 - Gate Charge Circuit (turn-off)

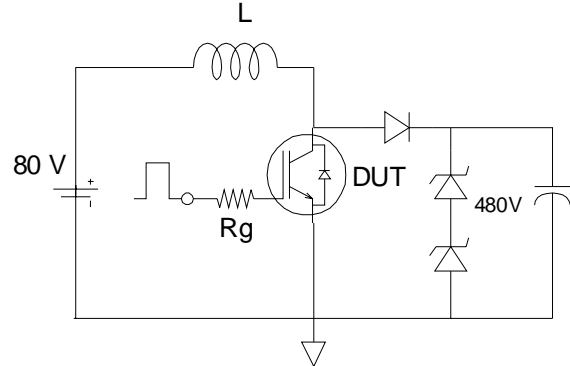

Fig.C.T.2 - RBSOA Circuit

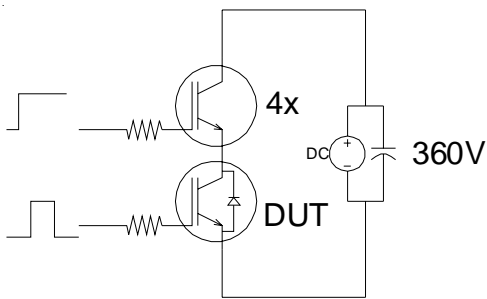

Fig.C.T.3 - S.C.SOA Circuit

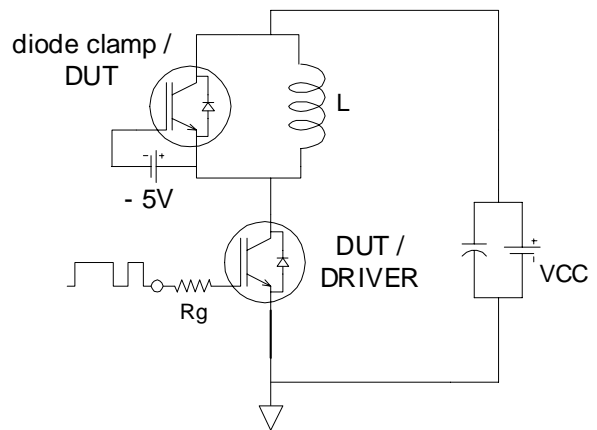

Fig.C.T.4 - Switching Loss Circuit

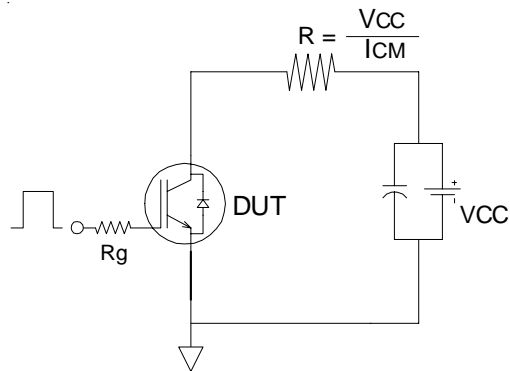

Fig.C.T.5 - Resistive Load Circuit

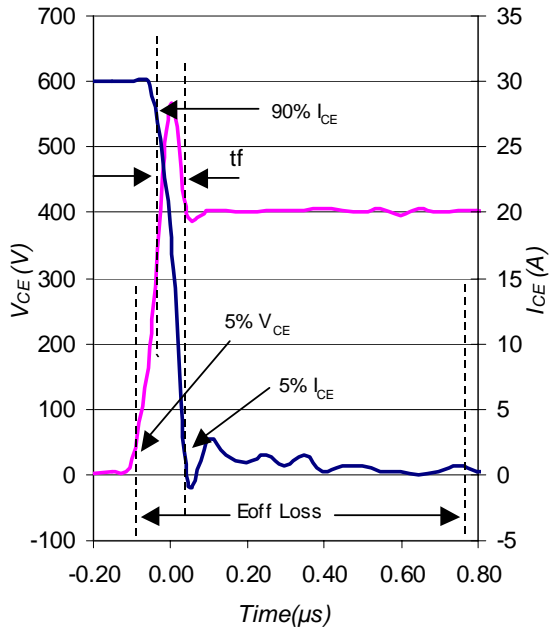

Fig. WF1- Typ. Turn-off Loss Waveform @ $T_J = 150^\circ C$ using Fig. CT.4

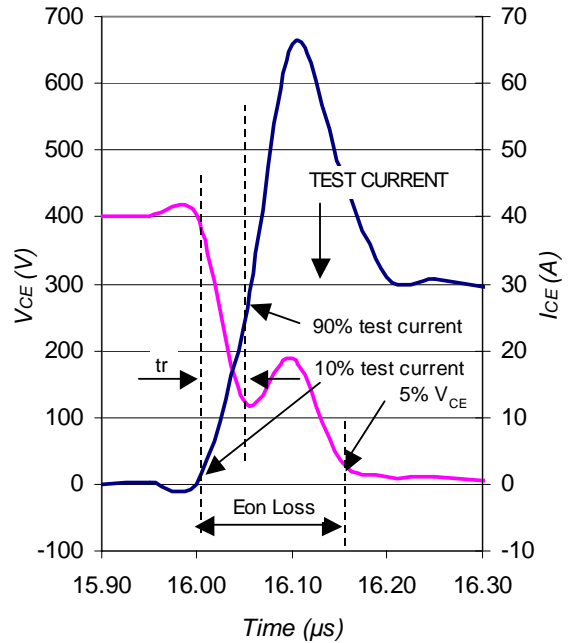

Fig. WF2- Typ. Turn-on Loss Waveform @ $T_J = 150^\circ C$ using Fig. CT.4

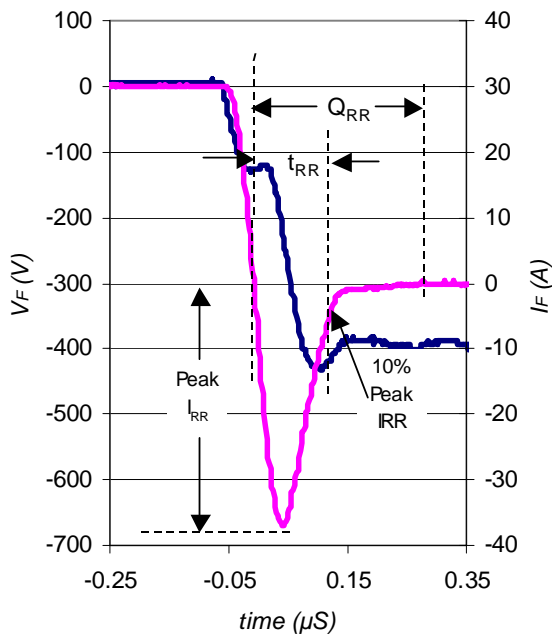

Fig. WF3- Typ. Diode Recovery Waveform @ $T_J = 150^\circ C$ using Fig. CT.4

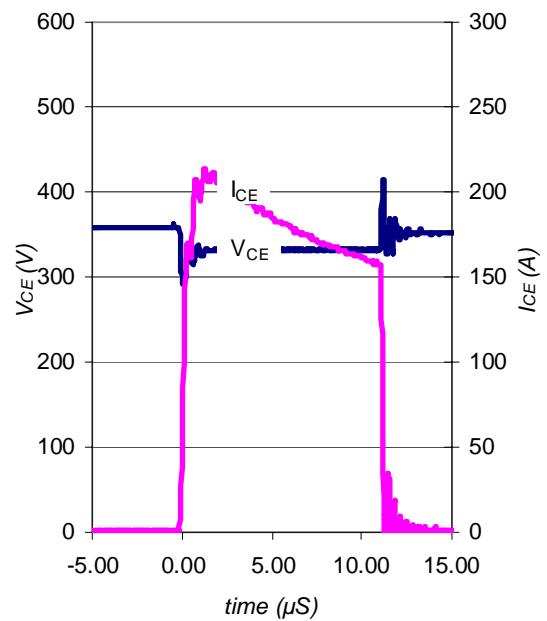

Fig. WF4- Typ. S.C. Waveform @ $T_C = 150^\circ C$ using Fig. CT.3

IRGP30B60KD-EP



TO-247AD Package Outline

Dimensions are shown in millimeters (inches)

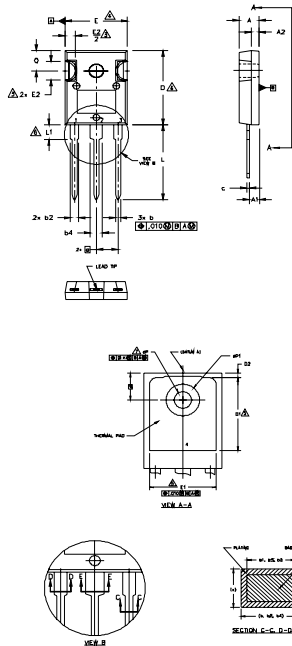

NOTES:

1. DIMENSIONING AND TOLERANCING AS PER ASME Y14.5M 1994.
2. DIMENSIONS ARE SHOWN IN INCHES.
3. CONTOUR OF SLOT OPTIONAL.
4. DIMENSION D & E DO NOT INCLUDE MOLD FLASH. MOLD FLASH SHALL NOT EXCEED .005" (0.127) PER SIDE. THESE DIMENSIONS ARE MEASURED AT THE OUTERMOST EXTREMES OF THE PLASTIC BODY.
5. THERMAL PAD CONTOUR OPTIONAL WITHIN DIMENSIONS D1 & E1.
6. LEAD FINISH UNCONTROLLED IN L1.
7. ØP TO HAVE A MAXIMUM DRAFT ANGLE OF 1.5 ° TO THE TOP OF THE PART WITH A MAXIMUM HOLE DIAMETER OF .154 INCH.
8. OUTLINE CONFORMS TO JEDEC OUTLINE TO-247AD.

SYMBOL	DIMENSIONS				NOTES
	INCHES		MILLIMETERS		
	MIN.	MAX.	MIN.	MAX.	
A	.183	.209	4.65	5.31	
A1	.087	.102	2.21	2.59	
A2	.059	.098	1.50	2.49	
b	.039	.055	0.99	1.40	
b1	.039	.053	0.99	1.35	
b2	.065	.094	1.65	2.39	
b3	.065	.092	1.65	2.34	
b4	.102	.135	2.59	3.43	
b5	.102	.133	2.59	3.38	
c	.015	.035	0.38	0.89	
c1	.015	.033	0.38	0.84	
D	.776	.815	19.71	20.70	4
D1	.515	-	13.08	-	5
D2	.020	.053	0.51	1.35	
E	.602	.625	15.29	15.87	4
E1	.530	-	13.46	-	
E2	.178	.216	4.52	5.49	
e	.215 BSC		5.46 BSC		
ØK	.010		0.25		
L	.780	.827	19.57	21.00	
L1	.146	.169	3.71	4.29	
ØP	.140	.144	3.56	3.66	
ØP1	-	.291	-	7.39	
Q	.209	.224	5.31	5.69	
S	.217 BSC		5.51 BSC		

LEAD ASSIGNMENTS

HEXFET

- 1.- GATE
- 2.- DRAIN
- 3.- SOURCE
- 4.- DRAIN

IGBTs, CoPACK

- 1.- GATE
- 2.- COLLECTOR
- 3.- EMITTER
- 4.- COLLECTOR

DIODES

- 1.- ANODE/OPEN
- 2.- CATHODE
- 3.- ANODE

TO-247AD Part Marking Information

EXAMPLE: THIS IS AN IRFPE30 WITH ASSEMBLY LOT CODE 5657 ASSEMBLED ON WW 35, 2000 IN THE ASSEMBLY LINE 'H'
Note: "P" in assembly line position indicates "Lead-Free"

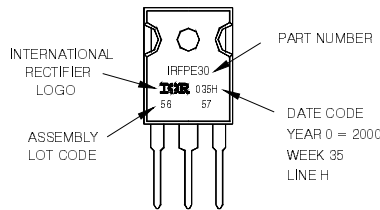

Data and specifications subject to change without notice. This product has been designed and qualified for Industrial market. Qualification Standards can be found on IR's Web site.



IR WORLD HEADQUARTERS: 233 Kansas St., El Segundo, California 90245, USA Tel: (310) 252-7105 TAC Fax: (310) 252-7903

Visit us at www.irf.com for sales contact information. 02/06

www.irf.com

Note: For the most current drawings please refer to the IR website at:
<http://www.irf.com/package/>