

PART NAME PLASTIBOX (STYLE "G")

PART No.

PSP-11573

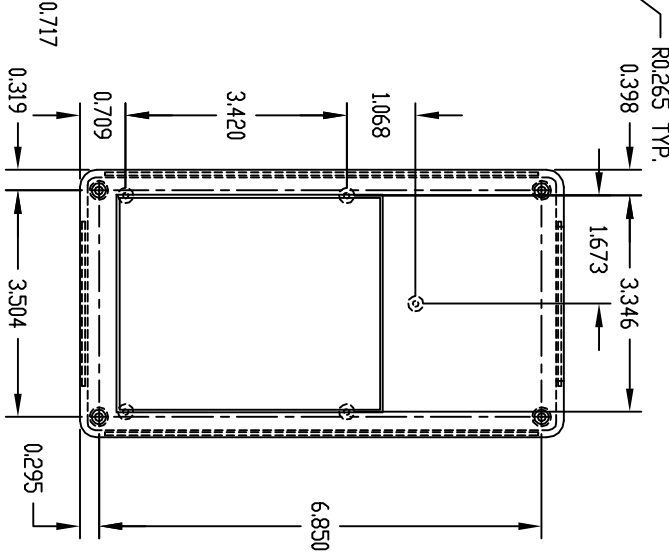
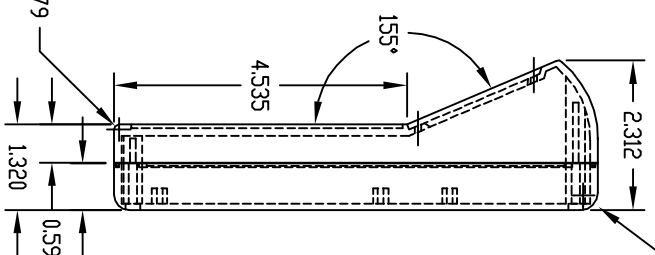
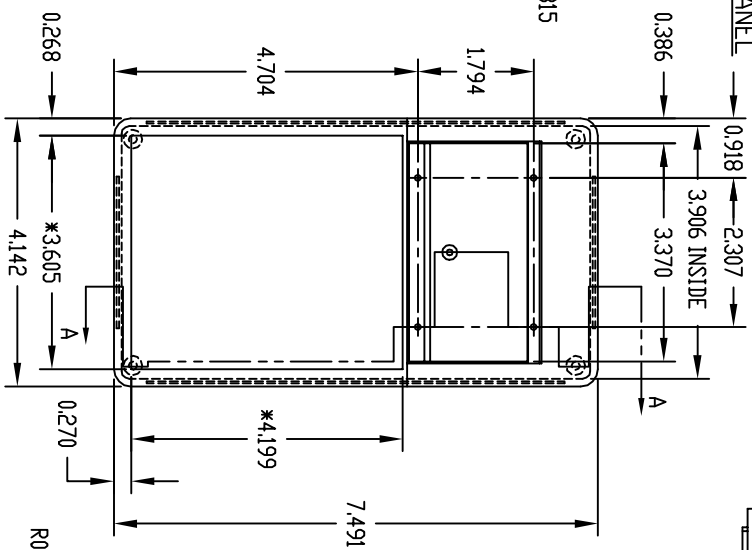
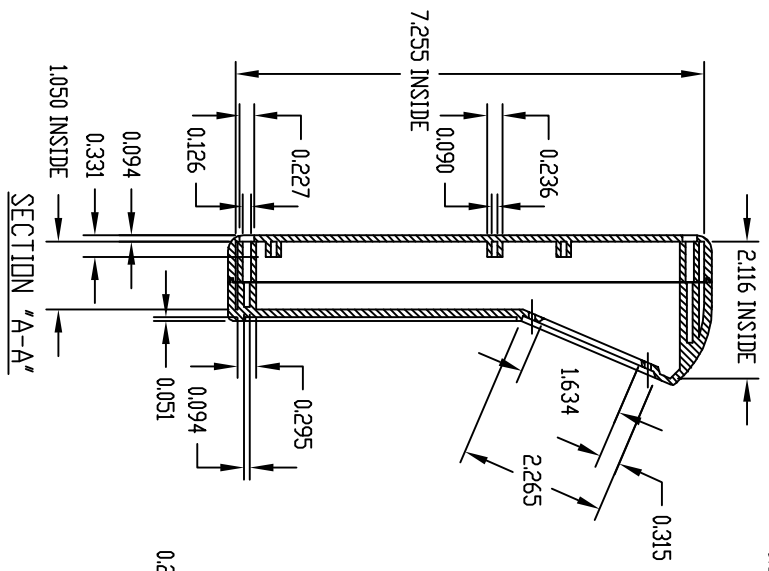
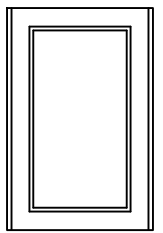
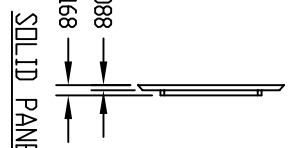
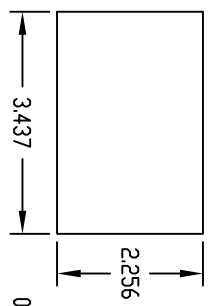
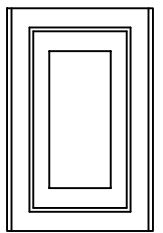
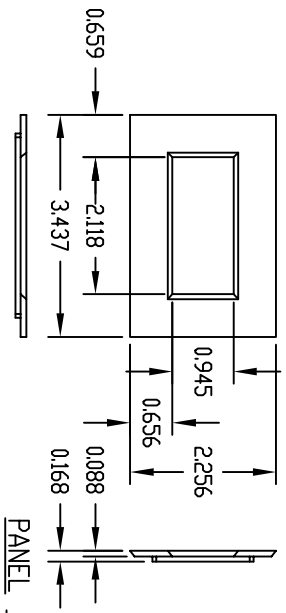

BASE AND COVER

MATERIAL - HIGH-IMPACT ABS
 COLOR - BLACK
 FINISH - TEXTURED BODY WITH SMOOTH TOP INSERT AREA
 * - SMOOTH AREA
 (4) M3 x 25.4mm SCREWS INCLUDED.
 ALL DIMENSIONS HAVE ±0.015 TOLERANCE.