

PART NAME

PLASTICASE

PART No.

PC-11466, PC-11467 & PC-11468

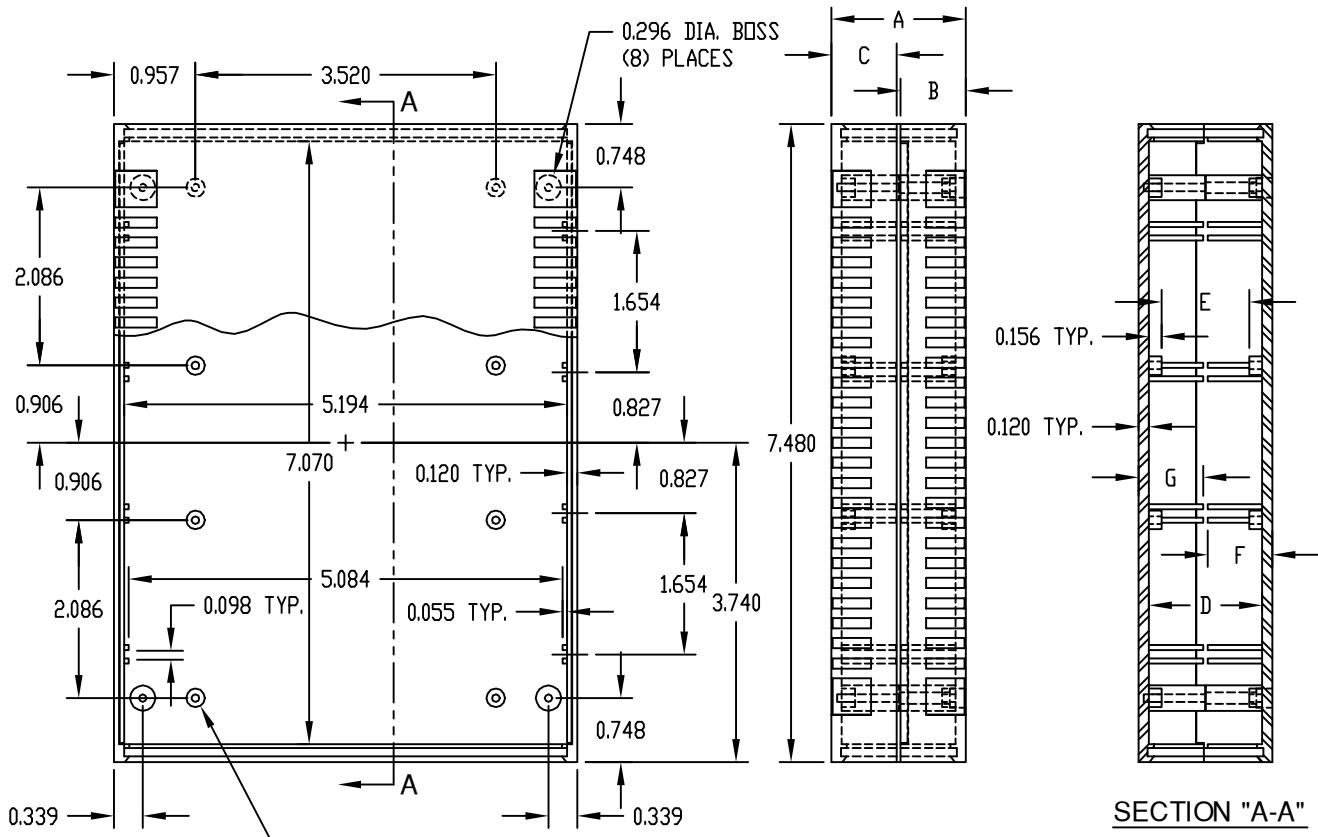

SECTION "A-A"

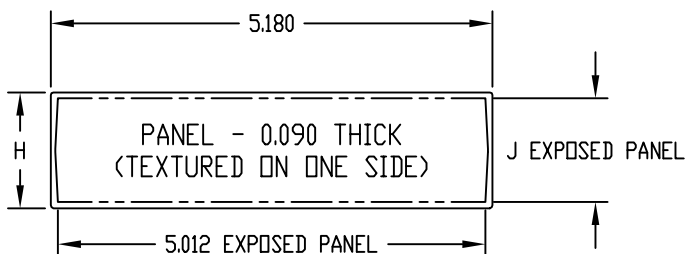
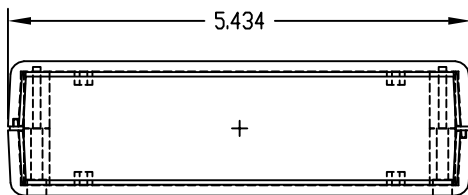

MATERIAL: ABS THERMOPLASTIC (UL 94-HB RATED)

FINISH: TOP & BOTTOM _____ LIGHT GRAY
 PANELS _____ DARK GRAY

FOR PC-11466 & PC-11467
 FOUR (4) M3 x 1.087 LG SCREWS SUPPLIED
 FOR ASSEMBLING BOTTOM TO TOP.

FOR PC-11468
 FOUR (4) M3 x 1.887 LG SCREWS SUPPLIED
 FOR ASSEMBLING BOTTOM TO TOP.

FOUR (4) RUBBER STICK-ON FEET SUPPLIED.

MOUNTING BOSSES USE EITHER M2.5 METRIC
 OR #4 STD. SHEET METAL SCREWS x 3/16 LG.
 (NOT SUPPLIED)

NOTE: ALL DIMENSIONS HAVE ±0.015 TOLERANCE
 UNLESS OTHERWISE SPECIFIED.

PART NO.	A	B	C	D	E	F	G	H	J
PC-11466	1.575	0.768	0.768	1.335	1.023	0.759	0.759	1.356	1.215
PC-11467	2.362	0.768	1.555	2.122	1.810	0.759	1.546	2.143	2.002
PC-11468	3.149	1.555	1.555	2.909	2.597	1.546	1.546	2.930	2.789