



575SX1A48S503SS

575 Series Commercial Potentiometer, Conductive Plastic Element, Solder Hook Terminals, 0.5 W Power Rating, 50 kOhm Resistance Value

Representative photograph, actual product appearance may vary.

Due to regional agency approval requirements, some products may not be available in your area. Please contact your regional Honeywell office regarding your product of choice.

Features

- All plastic construction
- Conductive plastic element
- Linear taper
- Solder hook terminals

Typical Applications

- Manual controls (throttle, joystick)
- Welding and heating
- Telecommunications

Description

The 575 Series is a low cost potentiometer with the benefits of a conductive plastic element. It is panel mounted and the housing and shaft are made from thermoplastic material.

575SX1A48S503SS

575 Series Commercial Potentiometer, Conductive Plastic Element, Solder Hook Terminals, 0.5 W Power Rating, 50 kOhm Resistance Value

Product Specifications	
Potentiometer Type	Commercial
Element Type	Conductive Plastic
Terminal Type	Solder Hook
Power Rating	0.5 W
Resistance Value	50 kOhm
Resistance Tolerance	± 20 %
Linearity	± 5 %
Bushing Thread	9,53 mm [0.375 in] x 32 NEF-2A
Bushing length	6,35 mm [0.25 in]
Bushing Type	Standard
Shaft Diameter	6,35 mm [0.25 in]
Shaft length	19,05 mm [0.75 in]
Shaft Ending	Slotted
Body	21.08 mm [0.83 in] square, ± 0.79 mm [0.031 in], except at terminal standoff
Electrical Taper	Linear
Operating Temperature	-40 °C to 120 °C [-40 °F to 248 °F]
Working Voltage (Max.)	350 V
Rotational Life	50000 cycles
Mechanical Rotation	300°
Availability	Global
Series Name	575 Series
UNSPSC Code	4111363300
UNSPSC Commodity	4111363300 Potentiometers

Honeywell

575SX1A48S503SS

575 Series Commercial Potentiometer, Conductive Plastic Element, Solder Hook Terminals, 0.5 W Power Rating, 50 kOhm Resistance Value

For Reference Only

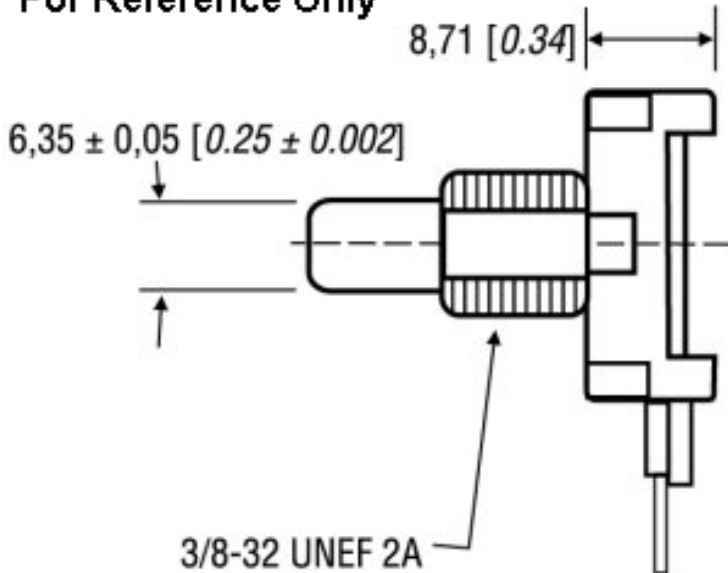

Solder Hook
Terminals

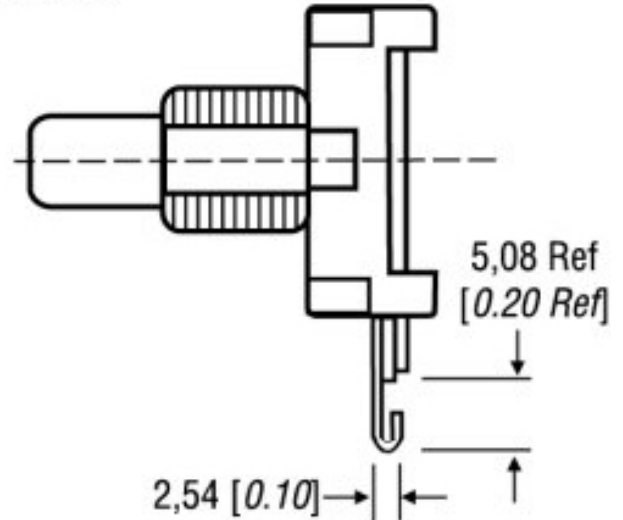

Honeywell

575SX1A48S503SS

575 Series Commercial Potentiometer, Conductive Plastic Element, Solder Hook Terminals, 0.5 W Power Rating, 50 kOhm Resistance Value

▲ WARNING

PERSONAL INJURY

DO NOT USE these products as safety or emergency stop devices, or in any other application where failure of the product could result in personal injury.

Failure to comply with these instructions could result in death or serious injury.

▲ WARNING

MISUSE OF DOCUMENTATION

- The information presented in this product sheet (or catalog) is for reference only. DO NOT USE this document as product installation information.
- Complete installation, operation and maintenance information is provided in the instructions supplied with each product.

Failure to comply with these instructions could result in death or serious injury.

