

# Dual Input Standalone Li-Ion Battery Charger

## FEATURES

- Charges Single-Cell Li-Ion Batteries from Wall Adapter and USB Inputs
- Automatic Input Power Detection and Selection
- Charge Current Programmable up to 950mA from Wall Adapter Input
- C/10 Charge Current Termination
- Thermal Regulation Maximizes Charge Rate Without Risk of Overheating\*
- Preset Charge Voltage with  $\pm 0.6\%$  Accuracy
- 18 $\mu$ A USB Suspend Current in Shutdown
- Power Present Status Output
- Charge Status Output
- Automatic Recharge
- Available in a Thermally Enhanced, Low Profile (0.75mm) 10-Lead (3mm  $\times$  3mm) DFN Package

## APPLICATIONS

- Cellular Telephones
- Handheld Computers
- Portable MP3 Players
- Digital Cameras

## DESCRIPTION

The LTC<sup>®</sup>4077 is a standalone linear charger that is capable of charging a single-cell Li-Ion battery from both wall adapter and USB inputs. The charger can detect power at the inputs and automatically select the appropriate power source for charging.

No external sense resistor or blocking diode is required for charging due to the internal MOSFET architecture. Internal thermal feedback regulates the battery charge current to maintain a constant die temperature during high power operation or high ambient temperature conditions. The float voltage is fixed at 4.2V and the charge current is programmed with an external resistor. The LTC4077 terminates the charge cycle when the charge current drops below the termination threshold after the final float voltage is reached. The LTC4077 can be put into shutdown mode reducing the DCIN supply current to 20 $\mu$ A, the USBIN supply current to 10 $\mu$ A, and the battery drain current to less than 2 $\mu$ A even with power applied to both inputs.

Other features include automatic recharge, undervoltage lockout, charge status output, power present status output to indicate the presence of wall adapter or USB power and high power/low power adjustable mode for USB compatible applications.

LT, LT, LTC and LTM are registered trademarks of Linear Technology Corporation. All other trademarks are the property of their respective owners. \*Protected by U.S. patents, including 6522118

## TYPICAL APPLICATION

Dual Input Battery Charger for Single-Cell Li-Ion

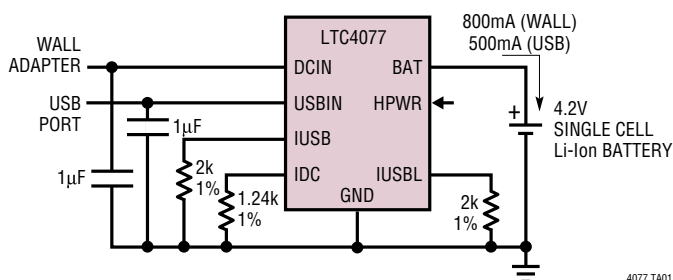

4077 TA01

Complete Charge Cycle (1100mAh Battery)

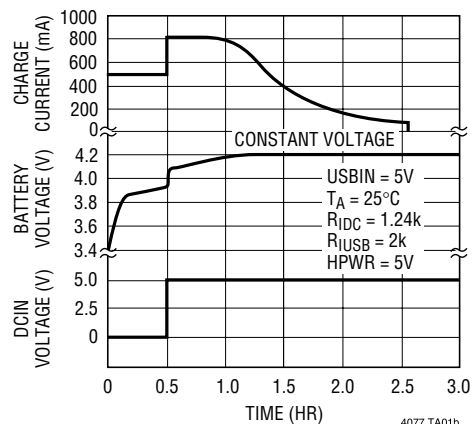

4077 TA01b

40771a

## ABSOLUTE MAXIMUM RATINGS

(Notes 1, 9)

Input Supply Voltage (DCIN, USBIN) .....	-0.3V to 10V
EN, CHRG, PWR, HPWR .....	-0.3V to 10V
BAT, IDC, IUSB, IUSBL .....	-0.3V to 7V
DCIN Pin Current (Note 6) .....	1A
USBIN Pin Current (Note 6) .....	700mA
BAT Pin Current (Note 6) .....	1A
BAT Short-Circuit Duration .....	Continuous
Maximum Junction Temperature .....	125°C
Operating Temperature Range (Note 2) ..	-40°C to 85°C
Storage Temperature Range .....	-65°C to 125°C

## PACKAGE/ORDER INFORMATION

TOP VIEW

DD PACKAGE  
10-LEAD (3mm × 3mm) PLASTIC DFN

$T_{JMAX} = 125^{\circ}\text{C}$ ,  $\theta_{JA} = 40^{\circ}\text{C/W}$  (NOTE 3)  
EXPOSED PAD (PIN 11) IS GND, MUST BE SOLDERED TO PCB

ORDER PART NUMBER	DD PART MARKING
LTC4077EDD	LBWD

**Order Options** Tape and Reel: Add #TR  
Lead Free: Add #PBF Lead Free Tape and Reel: Add #TRPBF  
Lead Free Part Marking: <http://www.linear.com/leadfree/>

Consult LTC Marketing for parts specified with wider operating temperature ranges.

## ELECTRICAL CHARACTERISTICS

The ● denotes the specifications which apply over the full operating temperature range, otherwise specifications are at  $T_A = 25^{\circ}\text{C}$ .  $V_{DCIN} = 5\text{V}$ ,  $V_{USBIN} = 5\text{V}$ ,  $HPWR = 5\text{V}$  unless otherwise noted.

SYMBOL	PARAMETER	CONDITIONS	MIN	TYP	MAX	UNITS	
$V_{DCIN}$	Supply Voltage		● 4.3		8	V	
$V_{USBIN}$	Supply Voltage		● 4.3		8	V	
$I_{DCIN}$	DCIN Supply Current	Charge Mode (Note 4), $R_{IDC} = 10\text{k}$ Standby Mode; Charge Terminated Shutdown Mode ( $EN = 5\text{V}$ )	●	150 50 20	700 100 40	$\mu\text{A}$ $\mu\text{A}$ $\mu\text{A}$	
$I_{USBIN}$	USBIN Supply Current	Charge Mode (Note 5), $R_{IUSB} = R_{IUSBL} = 10\text{k}$ , $V_{DCIN} = 0\text{V}$ Standby Mode; Charge Terminated, $V_{DCIN} = 0\text{V}$ Shutdown ( $V_{DCIN} = 0\text{V}$ , $EN = 5\text{V}$ ) $V_{DCIN} > V_{USBIN}$	● ●	150 50 18 10	700 100 36 20	$\mu\text{A}$ $\mu\text{A}$ $\mu\text{A}$ $\mu\text{A}$	
$V_{FLOAT}$	Regulated Output (Float) Voltage	$I_{BAT} = 1\text{mA}$ (Note 9) $I_{BAT} = 1\text{mA}$ , $0^{\circ}\text{C} < T_A < 85^{\circ}\text{C}$ , $4.3\text{V} < V_{CC} < 8\text{V}$		4.175 4.158	4.2 4.2	4.225 4.242	V V
$I_{BAT}$	BAT Pin Current	$R_{IDC} = 1.25\text{k}$ , Constant-Current Mode $R_{IUSB} = 2.1\text{k}$ , Constant-Current Mode $R_{IDC} = 10\text{k}$ or $R_{IUSB} = 10\text{k}$ $R_{IUSBL} = 4\text{k}$ , $HPWR = 0$ Standby Mode, Charge Terminated Shutdown Mode (Charger Disabled) Sleep Mode ( $V_{DCIN} = 0\text{V}$ , $V_{USBIN} = 0\text{V}$ )	● ● ● ●	760 450 92 44	800 476 100 50	840 500 108 56	$\text{mA}$ $\text{mA}$ $\text{mA}$ $\text{mA}$
				-3 -1	-6 -2	$\mu\text{A}$ $\mu\text{A}$	
				$\pm 1$	$\pm 2$	$\mu\text{A}$	
$V_{IDC}$	IDC Pin Regulated Voltage	Constant-Current Mode		0.95	1	1.05	V
$V_{IUSB}$	IUSB Pin Regulated Voltage	Constant-Current Mode		0.95	1	1.05	V
$V_{IUSBL}$	IUSBL Pin Regulated Voltage	Constant-Current Mode		0.18	0.2	0.22	V
$I_{C/10}$	Charge Current Termination Threshold	$V_{DCIN} = 5\text{V}$ , $R_{IDC} = 1.25\text{k}$ (Note 7) $V_{USBIN} = 5\text{V}$ , $V_{DCIN} = 0\text{V}$	● ●	0.09 0.09	0.1 0.1	0.11 0.11	$\text{mA}/\text{mA}$ $\text{mA}/\text{mA}$

## ELECTRICAL CHARACTERISTICS

The ● denotes the specifications which apply over the full operating temperature range, otherwise specifications are at  $T_A = 25^\circ\text{C}$ .  $V_{\text{DCIN}} = 5\text{V}$ ,  $V_{\text{USBIN}} = 5\text{V}$ ,  $\text{HPWR} = 5\text{V}$  unless otherwise noted.

SYMBOL	PARAMETER	CONDITIONS	MIN	TYP	MAX	UNITS	
$I_{\text{C}/2}$	Charge Current Termination Threshold	HPWR = 0V (Note 8)	●	0.45	0.5	0.55	mA/mA
$I_{\text{TRIKL}}$	Trickle Charge Current	$V_{\text{BAT}} < V_{\text{TRIKL}}$ ; $R_{\text{IDC}} = 1.25\text{k}$ $V_{\text{BAT}} < V_{\text{TRIKL}}$ ; $R_{\text{IUSB}} = 2.1\text{k}$ $V_{\text{BAT}} < V_{\text{TRIKL}}$ ; $R_{\text{IUSBL}} = 4\text{k}$		60 30 17	80 47.5 25	100 65 33	mA mA mA
$V_{\text{TRIKL}}$	Trickle Charge Threshold Voltage	$V_{\text{BAT}}$ Rising Hysteresis		2.8 2.9 100		3 V mV	
$V_{\text{UVDC}}$	DCIN Undervoltage Lockout Voltage	From Low to High Hysteresis		4 4.15 200		4.3 V mV	
$V_{\text{UVUSB}}$	USBIN Undervoltage Lockout Voltage	From Low to High Hysteresis		3.8 3.95 200		4.1 V mV	
$V_{\text{ASD-DC}}$	$V_{\text{DCIN}} - V_{\text{BAT}}$ Lockout Threshold	$V_{\text{DCIN}}$ from Low to High, $V_{\text{BAT}} = 4.2\text{V}$ $V_{\text{DCIN}}$ from High to Low, $V_{\text{BAT}} = 4.2\text{V}$		140 20	180 50	220 80	mV mV
$V_{\text{ASD-USB}}$	$V_{\text{USBIN}} - V_{\text{BAT}}$ Lockout Threshold	$V_{\text{USBIN}}$ from Low to High $V_{\text{USBIN}}$ from High to Low		140 20	180 50	220 80	mV mV
$\overline{V}_{\text{EN}}$	$\overline{\text{EN}}$ Input Threshold Voltage			0.4	0.7	1	V
$\overline{R}_{\text{EN}}$	$\overline{\text{EN}}$ Pulldown Resistance		●	1	2	5	$\text{M}\Omega$
$V_{\text{HPWR}}$	HPWR Input Threshold Voltage			0.4	0.7	1	V
$R_{\text{HPWR}}$	HPWR Pulldown Resistance		●	1	2	5	$\text{M}\Omega$
$V_{\text{CHRG}}$	$\overline{\text{CHRG}}$ Output Low Voltage	$I_{\text{CHRG}} = 5\text{mA}$			0.35	0.6	V
$V_{\text{PWR}}$	$\overline{\text{PWR}}$ Output Low Voltage	$I_{\text{PWR}} = 5\text{mA}$			0.35	0.6	V
$\Delta V_{\text{RECHRG}}$	Recharge Battery Threshold Voltage	$V_{\text{FLOAT}} - V_{\text{RECHRG}}$ , $0^\circ\text{C} < T_A < 85^\circ\text{C}$		65	100	135	mV
$t_{\text{RECHRG}}$	Recharge Comparator Filter Time	$V_{\text{BAT}}$ from High to Low		3	6	10	ms
$t_{\text{TERMINATE}}$	Termination Comparator Filter Time	$I_{\text{BAT}}$ Drops Below Termination Threshold		0.8	1.5	2.2	ms
$t_{\text{SS}}$	Soft-Start Time	$I_{\text{BAT}} = 10\%$ to $90\%$ Full-Scale		175	250	325	$\mu\text{s}$
$R_{\text{ON-DC}}$	Power FET "ON" Resistance (Between DCIN and BAT)				400		$\text{m}\Omega$
$R_{\text{ON-USB}}$	Power FET "ON" Resistance (Between USBIN and BAT)				550		$\text{m}\Omega$
$T_{\text{LIM}}$	Junction Temperature in Constant-Temperature Mode				105		$^\circ\text{C}$

**Note 1:** Stresses beyond those listed under Absolute Maximum Ratings may cause permanent damage to the device. Exposure to any Absolute Maximum Rating condition for extended periods may affect device reliability and lifetime.

**Note 2:** The LTC4077E is guaranteed to meet the performance specifications from  $0^\circ\text{C}$  to  $85^\circ\text{C}$ . Specifications over the  $-40^\circ\text{C}$  to  $85^\circ\text{C}$  operating temperature range are assured by design, characterization and correlation with statistical process controls.

**Note 3:** Failure to correctly solder the exposed backside of the package to the PC board will result in a thermal resistance much higher than  $40^\circ\text{C}/\text{W}$ . See Thermal Considerations.

**Note 4:** Supply current includes IDC pin current (approximately  $100\mu\text{A}$ ) but does not include any current delivered to the battery through the BAT pin.

**Note 5:** Supply current includes IUSB and IUSBL pin currents (approximately  $100\mu\text{A}$  each) but does not include any current delivered to the battery through the BAT pin.

**Note 6:** Guaranteed by long term current density limitations.

**Note 7:**  $I_{\text{C}/10}$  is expressed as a fraction of measured full charge current.

**Note 8:**  $I_{\text{C}/2}$  is expressed as a fraction of measured full charge current.

**Note 9:**  $V_{\text{CC}}$  is greater of DCIN or USBIN.

# TYPICAL PERFORMANCE CHARACTERISTICS

**Regulated Output (Float) Voltage vs Charge Current**

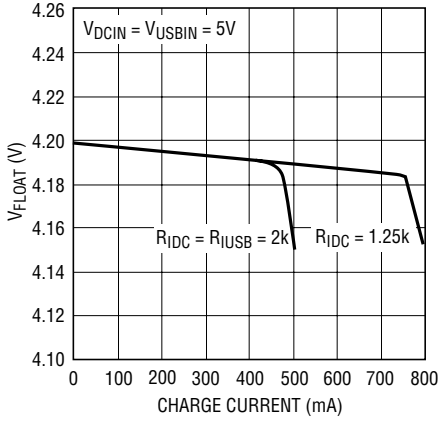

4077 G01

**Regulated Output (Float) Voltage vs Temperature**

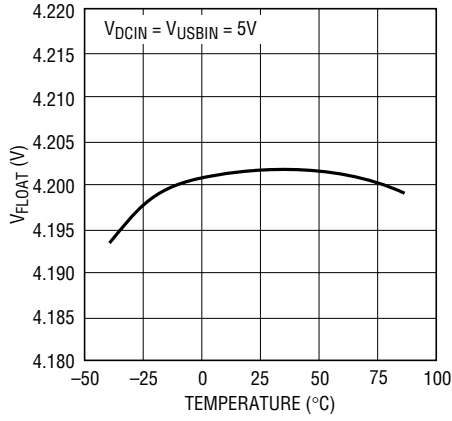

4077 G02

**IDC Pin Voltage vs Temperature (Constant-Current Mode)**

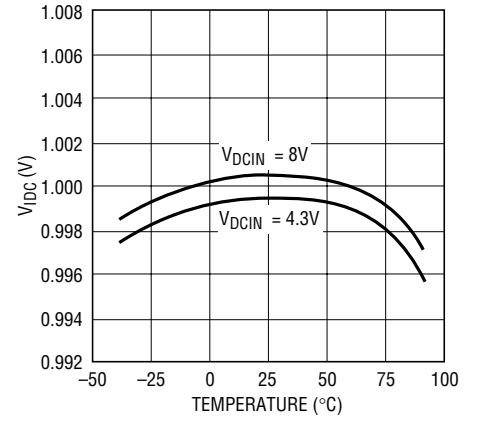

4077 G03

**IUSB Pin Voltage vs Temperature (Constant-Current Mode)**

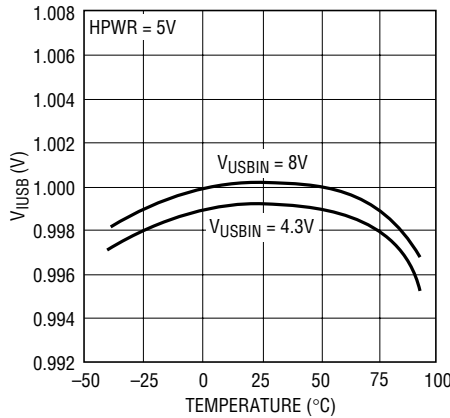

4077 G04

**IUSBL Pin Voltage vs Temperature (Constant-Current Mode)**

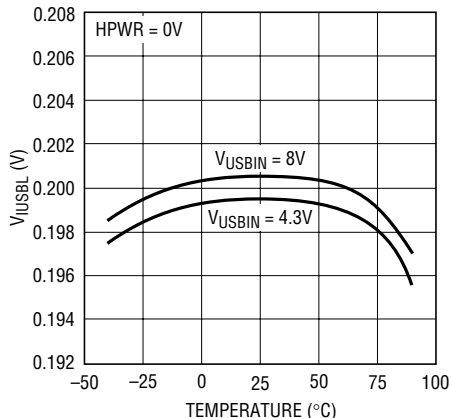

4077 G24

**Charge Current vs IDC Pin Voltage**

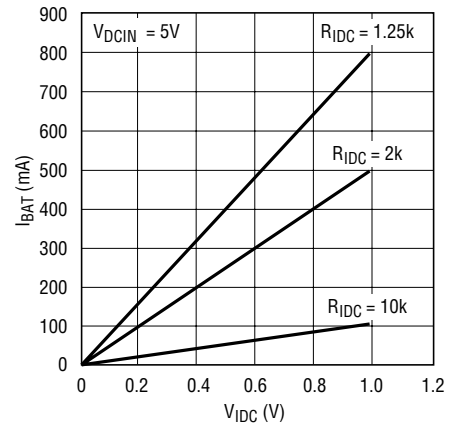

4077 G05

**Charge Current vs IUSB Pin Voltage**

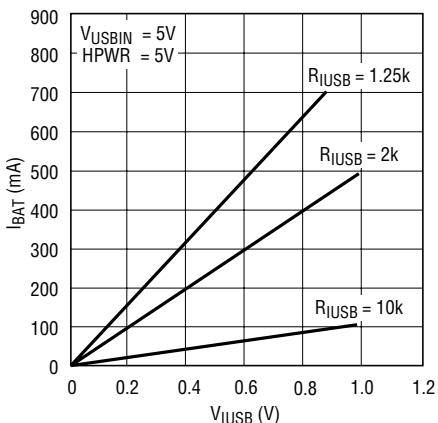

4077 G06

**Charge Current vs IUSBL Pin Voltage**

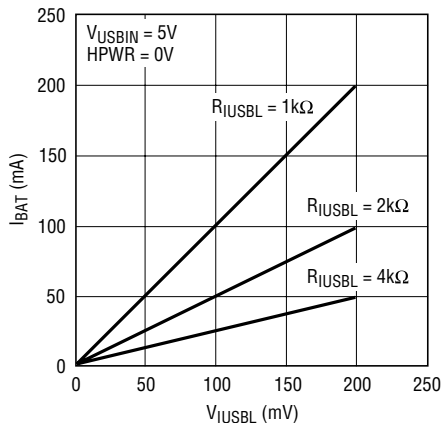

4077 G25

**PWR Pin I-V Curve**

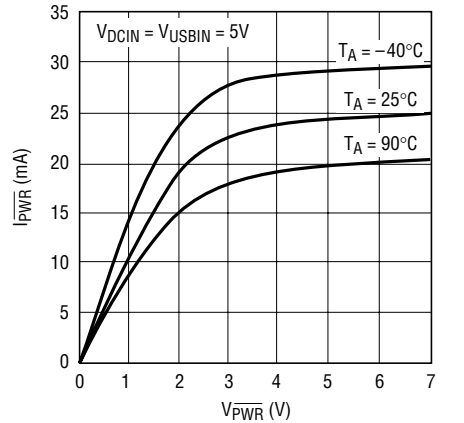

4077 G07

# TYPICAL PERFORMANCE CHARACTERISTICS

**CHRG Pin I-V Curve**

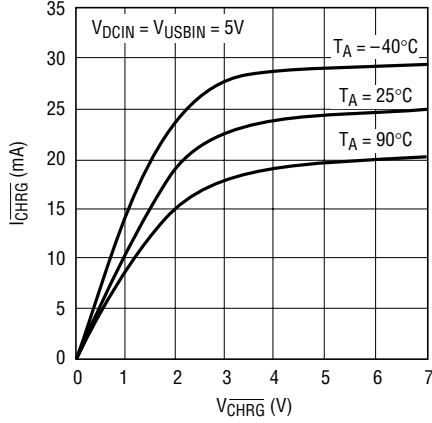

4077 G08

**Charge Current vs Ambient Temperature**

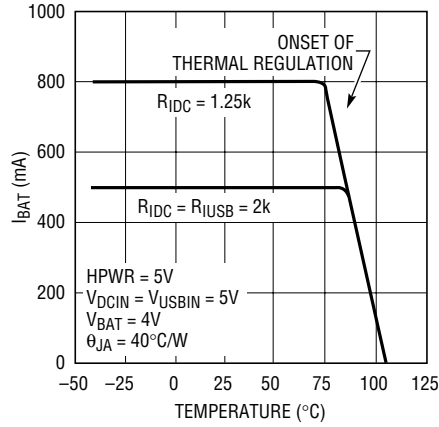

4077 G09

**Charge Current vs Supply Voltage**

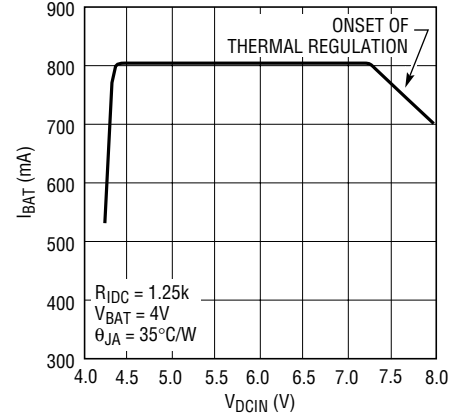

4077 G10

**Charge Current vs Battery Voltage**

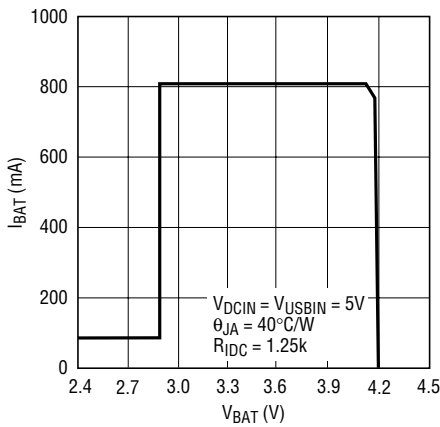

4077 G11

**DCIN Power FET "On" Resistance vs Temperature**

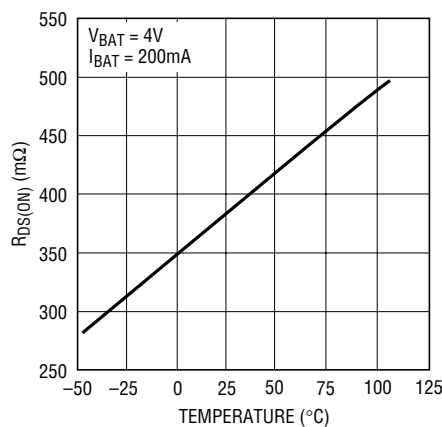

4077 G12

**USBIN Power FET "On" Resistance vs Temperature**

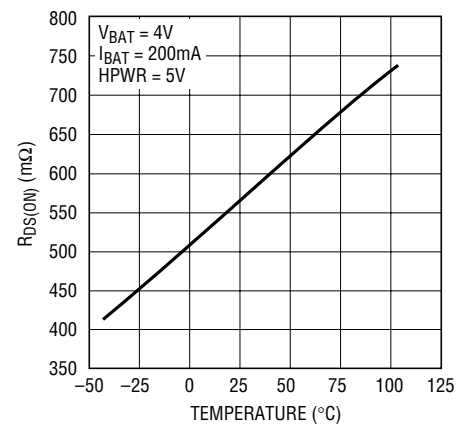

4077 G13

**EN Pin Threshold (Rising) vs Temperature**

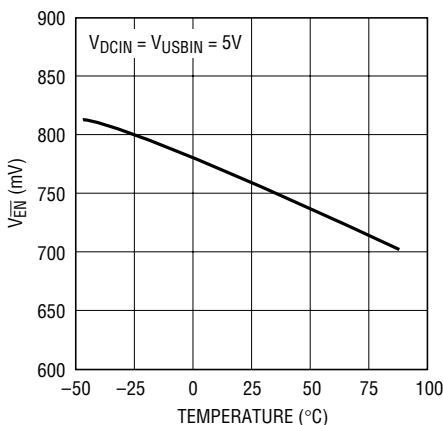

4077 G14

**HPWR Pin Threshold (Rising) vs Temperature**

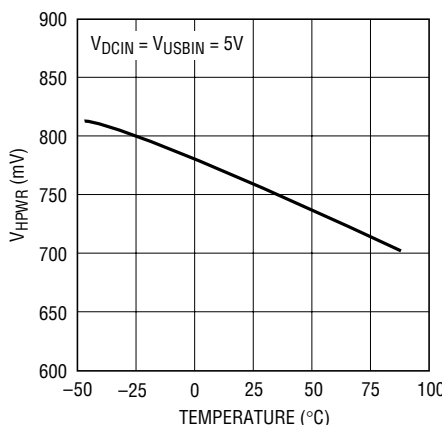

4077 G15

**DCIN Shutdown Current vs Temperature**

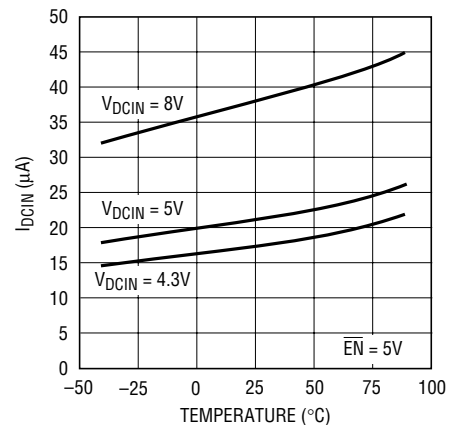

4077 G16

## TYPICAL PERFORMANCE CHARACTERISTICS

**USBIN Shutdown Current vs Temperature**

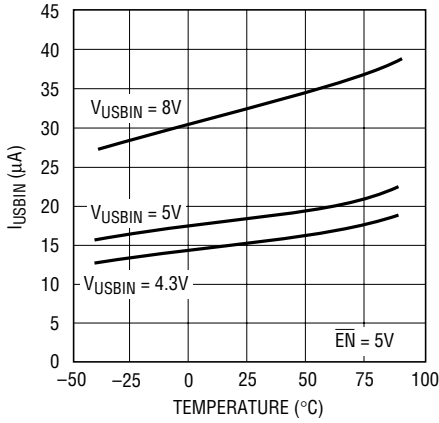

4077 G17

**EN Pin Pulldown Resistance vs Temperature**

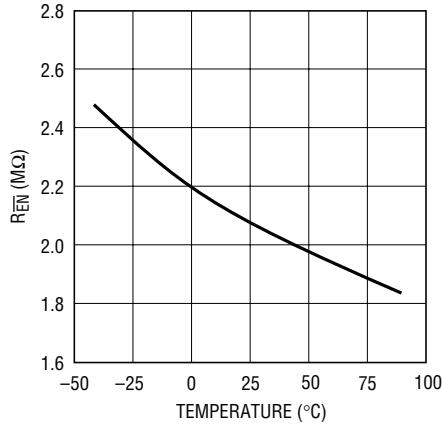

4077 G18

**HPWR Pin Pulldown Resistance vs Temperature**

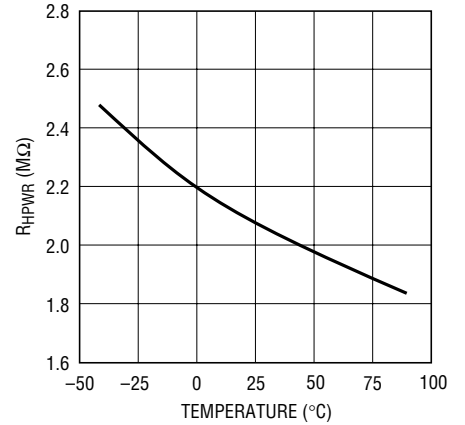

4077 G19

**Undervoltage Lockout Threshold vs Temperature**

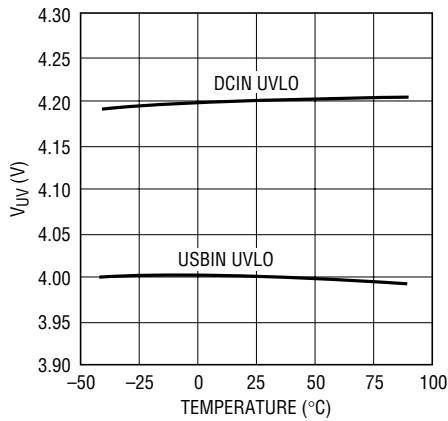

4077 G20

**Recharge Threshold vs Temperature**

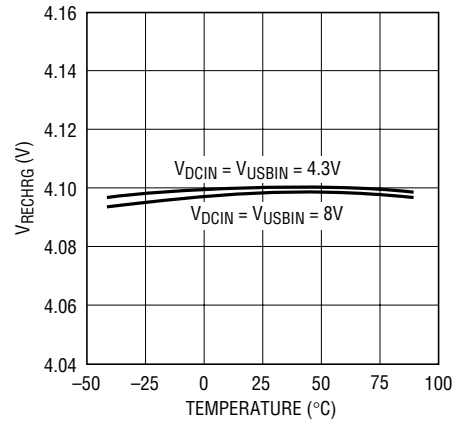

4077 G21

**Battery Drain Current vs Temperature**

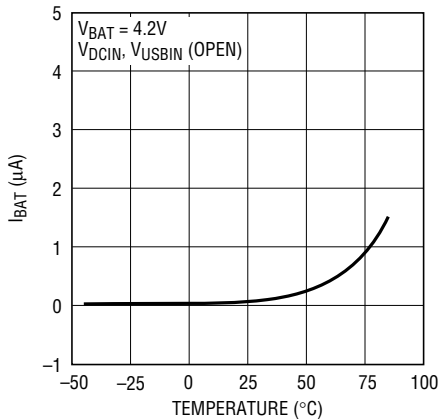

4077 G22

**Charge Current at Turn-On and Turn-Off**

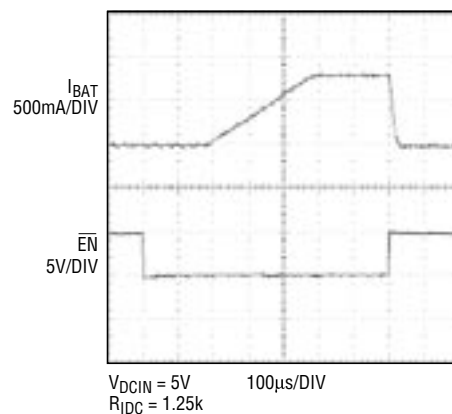

4077 G23

## PIN FUNCTIONS

**USBIN (Pin 1):** USB Input Supply Pin. Provides power to the battery charger. The maximum supply current is 650mA. This pin should be bypassed with a 1 $\mu$ F capacitor.

**IUSB (Pin 2):** Charge Current Program for High USB Power. The charge current is set by connecting a resistor,  $R_{IUSB}$ , to ground. When charging in constant-current mode, this pin servos to 1V. The voltage on this pin can be used to measure the battery current delivered from the USB input using the following formula:

$$I_{BAT} = \frac{V_{IUSB}}{R_{IUSB}} \cdot 1000$$

**IUSBL (Pin 3):** Charge Current Program for Low USB Power. The charge current is set by connecting a resistor,  $R_{IUSBL}$ , to ground. When charging in constant current mode, this pin servos to 0.2V. The voltage on this pin can be used to measure the battery current delivered from the USB input using the following formula:

$$I_{BAT} = \frac{V_{IUSBL}}{R_{IUSBL}} \cdot 200$$

**PWR (Pin 4):** Open-Drain Power Supply Status Output. When the DCIN or USBIN pin voltage is sufficient to begin charging (i.e. when the supply is greater than the under-voltage lockout threshold and at least 180mV above the battery terminal), the  $\overline{PWR}$  pin is pulled low by an internal N-channel MOSFET. Otherwise  $\overline{PWR}$  is high impedance. This output is capable of sinking up to 10mA, making it suitable for driving an LED.

**CHRG (Pin 5):** Open-Drain Charge Status Output. When the LTC4077 is charging, the  $\overline{CHRG}$  pin is pulled low by an internal N-channel MOSFET. When the charge cycle is completed,  $\overline{CHRG}$  becomes high impedance. This output is capable of sinking up to 10mA, making it suitable for driving an LED.

**$\overline{EN}$  (Pin 6):** Charge Enable Input. A logic low on this pin enables the charger. If left floating, an internal 2M $\Omega$  pull-down resistor defaults the LTC4077 to charge mode. Pull this pin high for shutdown.

**HPWR (Pin 7):** HPWR Enable Input. Used to control the amount of current drawn from the USB port. A logic high on the HPWR pin sets the current limit at the current programmed by the IUSB pin. A logic low on the HPWR pin sets the current limit at the current programmed by the IUSBL pin. An internal 2M $\Omega$  pull-down resistor defaults the HPWR pin to its low current state.

**IDC (Pin 8):** Charge Current Program for Wall Adapter Power. The charge current is set by connecting a resistor,  $R_{IDC}$ , to ground. When charging in constant-current mode, this pin servos to 1V. The voltage on this pin can be used to measure the battery current delivered from the DC input using the following formula:

$$I_{BAT} = \frac{V_{IDC}}{R_{IDC}} \cdot 1000$$

**BAT (Pin 9):** Charger Output. This pin provides charge current to the battery and regulates the final float voltage to 4.2V.

**DCIN (Pin 10):** Wall Adapter Input Supply Pin. Provides power to the battery charger. The maximum supply current is 950mA. This should be bypassed with a 1 $\mu$ F capacitor.

**Exposed Pad (Pin 11):** GND. The exposed backside of the package is ground and must be soldered to PC board ground for electrical connection and maximum heat transfer.

## BLOCK DIAGRAM

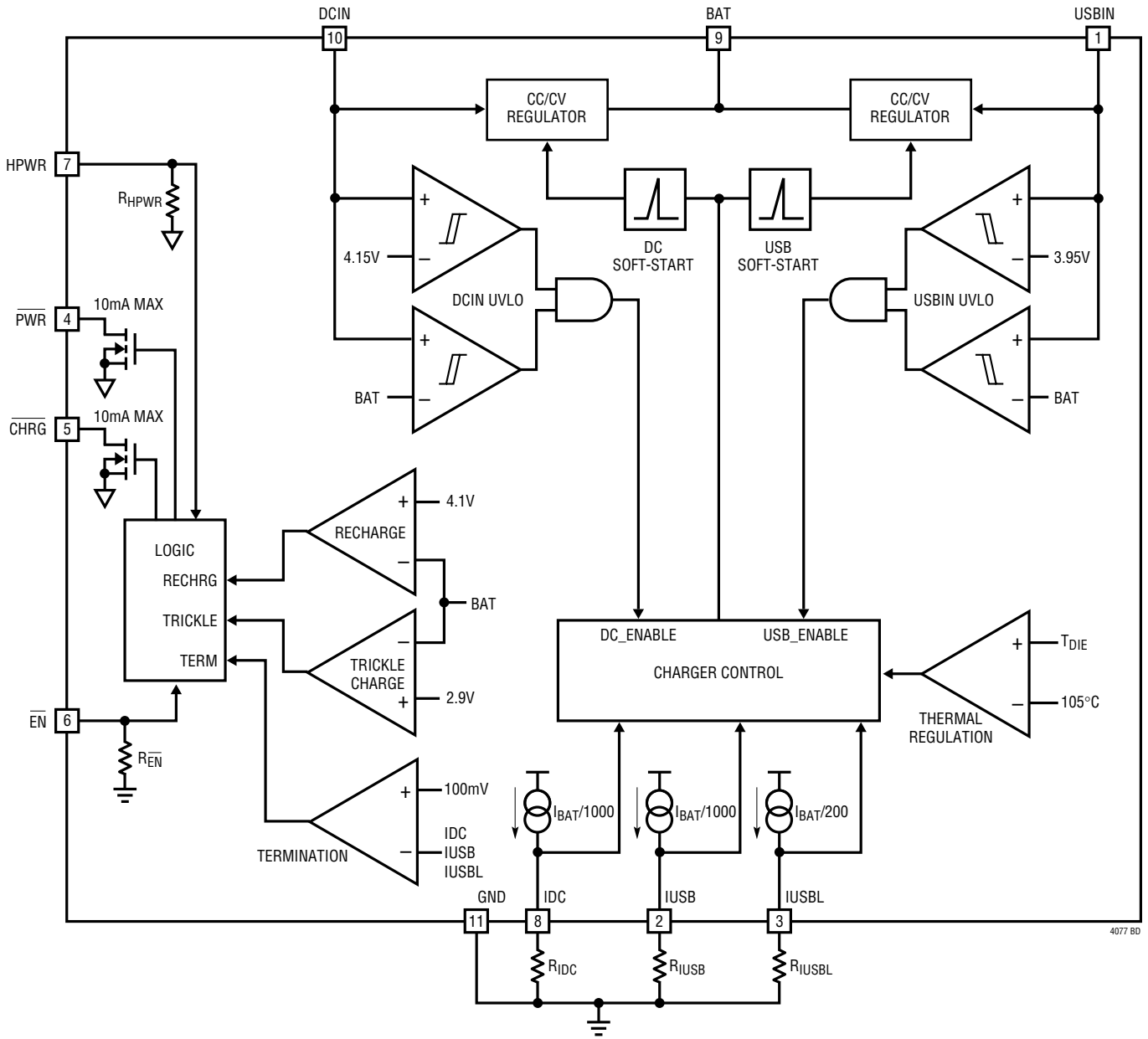

4077 BD



## OPERATION

The LTC4077 is designed to efficiently manage charging of a single-cell lithium-ion battery from two separate power sources: a wall adapter and USB power bus. Using the constant-current/constant-voltage algorithm, the charger can deliver up to 950mA of charge current from the wall adapter supply or up to 650mA of charge current from the USB supply with a final float voltage accuracy of  $\pm 0.6\%$ . The LTC4077 has two internal P-channel power MOSFETs and thermal regulation circuitry. No blocking diodes or external sense resistors are required.

### Power Source Selection

The LTC4077 can charge a battery from either the wall adapter input or the USB port input. The LTC4077 automatically senses the presence of voltage at each input. If both power sources are present, the LTC4077 defaults to the wall adapter source provided sufficient power is present at the DCIN input. "Sufficient power" is defined as:

- Supply voltage is greater than the UVLO threshold.
- Supply voltage is greater than the battery voltage by 50mV (180mV rising, 50mV falling).

The open drain power status output ( $\overline{\text{PWR}}$ ) indicates that sufficient power is available. Table 1 describes the behavior of this status output.

**Table 1. Power Source Selection**

	$V_{\text{USBIN}} > 3.95\text{V}$ and $V_{\text{USBIN}} > \text{BAT} + 50\text{mV}$	$V_{\text{USBIN}} < 3.95\text{V}$ or $V_{\text{USBIN}} < \text{BAT} + 50\text{mV}$
$V_{\text{DCIN}} > 4.15\text{V}$ and $V_{\text{DCIN}} > \text{BAT} + 50\text{mV}$	Device powered from wall adapter source; USBIN current $< 25\mu\text{A}$ $\overline{\text{PWR}}$ : LOW	Device powered from wall adapter source  $\overline{\text{PWR}}$ : LOW
$V_{\text{DCIN}} < 4.15\text{V}$ or $V_{\text{DCIN}} < \text{BAT} + 50\text{mV}$	Device powered from USB source; $\overline{\text{PWR}}$ : LOW	No charging  $\overline{\text{PWR}}$ : Hi-Z

### Programming and Monitoring Charge Current

The charge current delivered to the battery from the wall adapter supply is programmed using a single resistor from the IDC pin to ground. Likewise, the charge current from the USB supply is programmed using a single resistor from the IUSB pin to ground if HPWR is set on its high logic state or from the IUSBL pin to ground if HPWR is set on its low logic state or it is left floating. The program resistor and the charge current ( $I_{\text{CHRG}}$ ) are calculated using the following equations:

$$R_{\text{IDC}} = \frac{1000\text{V}}{I_{\text{CHRG(DC)}}}, I_{\text{CHRG(DC)}} = \frac{1000\text{V}}{R_{\text{IDC}}}$$

$$R_{\text{IUSB}} = \frac{1000\text{V}}{I_{\text{CHRG(USB)}}}, I_{\text{CHRG(USB)}} = \frac{1000\text{V}}{R_{\text{IUSB}}}$$

$$R_{\text{IUSBL}} = \frac{200\text{V}}{I_{\text{CHRG(USB)}}}, I_{\text{CHRG(USB)}} = \frac{200\text{V}}{R_{\text{IUSBL}}}$$

Charge current out of the BAT pin can be determined at any time by monitoring the IDC or IUSB pin voltage and using the following equations:

$$I_{\text{BAT}} = \frac{V_{\text{IDC}}}{R_{\text{IDC}}} \cdot 1000, \text{ (charging from wall adapter)}$$

$$I_{\text{BAT}} = \frac{V_{\text{IUSB}}}{R_{\text{IUSB}}} \cdot 1000, \text{ (charging from USB supply, HPWR = high)}$$

$$I_{\text{BAT}} = \frac{V_{\text{IUSBL}}}{R_{\text{IUSBL}}} \cdot 200, \text{ (charging from USB supply, HPWR = low)}$$

## OPERATION

### Programming Charge Termination

The charge cycle terminates when the voltage at the IUSB, IUSBL and IDC pins falls below 100mV. For wall adapter or high power USB use the charge termination is set to 1/10th of the programmed charge current. For low power USB use (HPWR = 0V) the charge termination is set to 1/2 of the programmed charge current.

The termination condition is detected by using an internal filtered comparator to monitor the IDC, IUSB and IUSBL pin voltages. When one of these voltages drops below 100mV\* for longer than  $t_{\text{TERMINATE}}$  (typically 1.5ms), the charge cycle terminates, charge current latches off and the LTC4077 enters standby mode.

When charging, transient loads on the BAT pin can cause the active charge current program pin to fall below 100mV for short periods of time before the steady-state charge current has dropped below the programmed termination current. The 1.5ms filter time ( $t_{\text{TERMINATE}}$ ) on the termination comparator ensures that transient loads of this nature do not result in premature charge cycle termination. Once the *average* charge current drops below the termination threshold, the LTC4077 terminates the charge cycle and ceases to provide any current out of the BAT pin. In this state, any load on the BAT pin must be supplied by the battery.

### Low-Battery Charge Conditioning (Trickle Charge)

This feature ensures that deeply discharged batteries are gradually charged before reapplying full charge current. If the BAT pin voltage is below 2.9V, the LTC4077 supplies 1/10th of the full charge current to the battery, when HPWR = high or 1/2 of the full charge current (programmed by  $R_{\text{IUSBL}}$ ) to the battery when HPWR = low, until the BAT pin rises above 2.9V. For example, if the charger is programmed to charge at 800mA from the wall adapter input and 500mA from the USB input when HPWR is high or 50mA if HPWR is low, the charge current during trickle charge mode would be 80mA, 50mA and 25mA respectively.

### Automatic Recharge

In standby mode, the charger sits idle and monitors the battery voltage using a comparator with a 6ms filter time ( $t_{\text{RECHRG}}$ ). A charge cycle automatically restarts when the battery voltage falls below 4.1V (which corresponds to approximately 80%-90% battery capacity). This ensures that the battery is kept at, or near, a fully charged condition and eliminates the need for periodic charge cycle initiations.

If the battery is removed from the charger, a sawtooth waveform of approximately 100mV appears at the battery output. This is caused by the repeated cycling between termination and recharge events. This cycling results in pulsing at the CHRG output; an LED connected to this pin will exhibit a blinking pattern, indicating to the user that a battery is not present. The frequency of the sawtooth is dependent on the amount of output capacitance.

### Manual Shutdown

The  $\overline{\text{EN}}$  pin has a 2M $\Omega$  pulldown resistor to GND. A logic low enables the charger and logic high disables it (the pulldown defaults the charger to the charging state).

The DCIN input draws 20 $\mu$ A when the charger is in shutdown. The USBIN input draws 18 $\mu$ A during shutdown if no power is applied to DCIN, but draws only 10 $\mu$ A when  $V_{\text{DCIN}} > V_{\text{USBIN}}$ .

### Charge Current Soft-Start and Soft-Stop

The LTC4077 includes a soft-start circuit to minimize the inrush current at the start of a charge cycle. When a charge cycle is initiated, the charge current ramps from zero to full-scale current over a period of 250 $\mu$ s. Likewise, internal circuitry slowly ramps the charge current from full-scale to zero in a period of approximately 30 $\mu$ s when the charger shuts down or self terminates. This minimizes the transient current load on the power supply during start-up and shut-off.

\*Any external sources that hold the pin above 100mV will prevent the LTC4077 from terminating a charge cycle.

# OPERATION

## Status Indicators

The charge status output ( $\overline{\text{CHRG}}$ ) has two states: pull-down and high impedance. The pull-down state indicates that the LTC4077 is in a charge cycle. Once the charge cycle has terminated or the LTC4077 is disabled, the pin state becomes high impedance. The pull-down state is capable of sinking up to 10mA.

The power supply status output ( $\overline{\text{PWR}}$ ) has two states: pull-down and high impedance. The pull-down state indicates that power is present at either DCIN or USBIN. If no power is applied at either pin, the  $\overline{\text{PWR}}$  pin is high impedance, indicating that the LTC4077 lacks sufficient power to charge the battery. The pull-down state is capable of sinking up to 10mA.

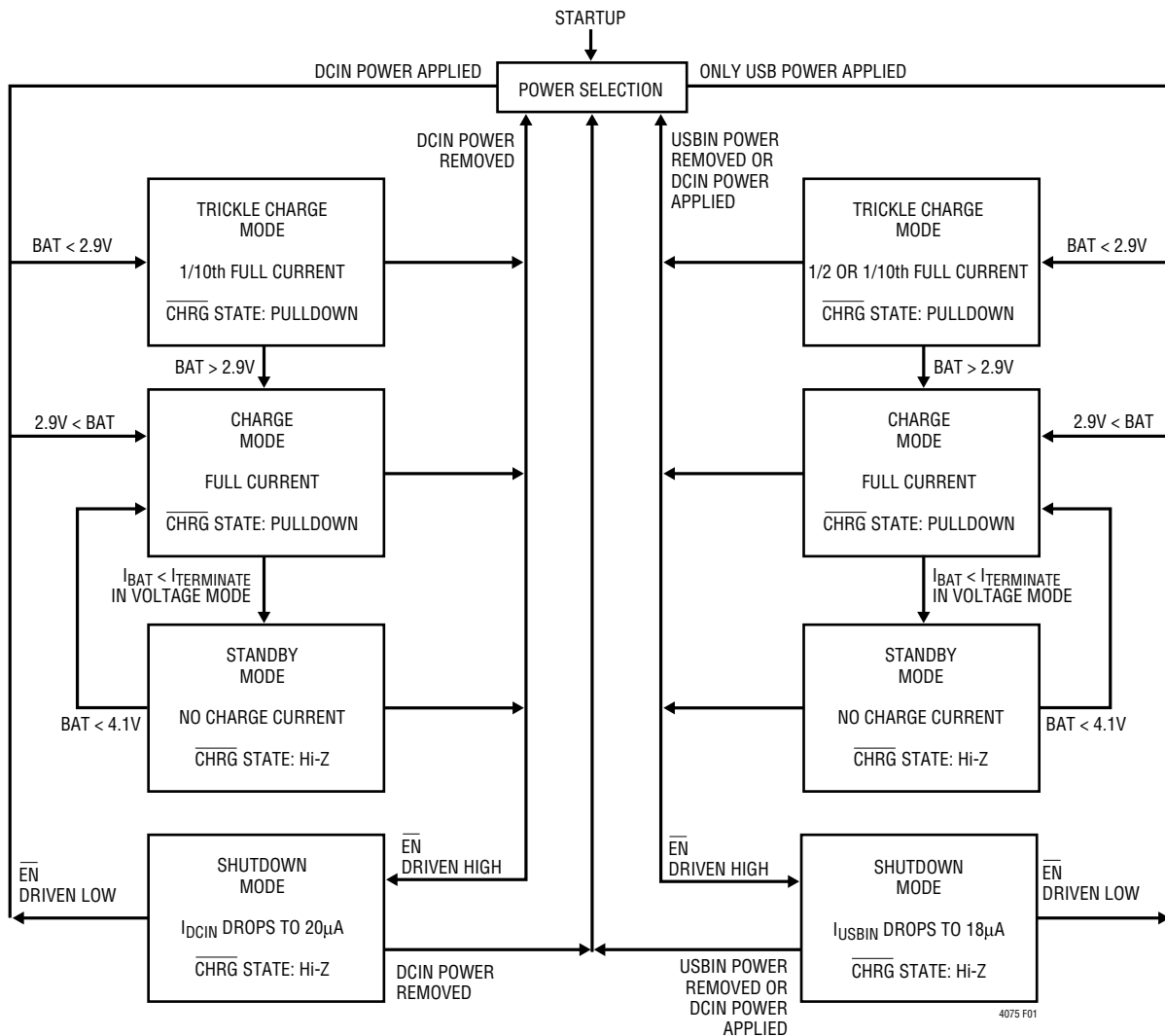

Figure 1. LTC4077 State Diagram of a Charge Cycle

## APPLICATIONS INFORMATION

### Thermal Limiting

An internal thermal feedback loop reduces the programmed charge current if the die temperature attempts to rise above a preset value of approximately 105°C. This feature protects the LTC4077 from excessive temperature and allows the user to push the limits of the power handling capability of a given circuit board without risk of damaging the device. The charge current can be set according to typical (not worst-case) ambient temperature with the assurance that the charger will automatically reduce the current in worst-case conditions. DFN power considerations are discussed further in the Applications Information section.

### Using a Single Charge Current Program Resistor

In applications where the programmed wall adapter charge current and USB charge current are the same, a single program resistor can be used to set both charge currents. Figure 2 shows a charger circuit that uses one

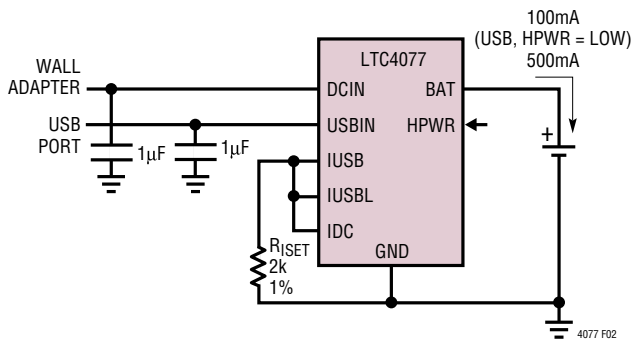

**Figure 2. Dual Input Charger Circuit. The Wall Adapter Charge Current and USB Charge Currents (HPWR = High) are Both Programmed to be 500mA. If USBIN is the Supply and HPWR = Low, the Charge Current is 100mA**

charge current program resistor. In this circuit, one resistor programs the same charge current for each input supply (with HPWR = HIGH).

$$I_{\text{CHRG(DC)}} = I_{\text{CHRG(USB)}} = \frac{1000V}{R_{\text{ISET}}}$$

The programmed charge current for USB supply with HPWR in its low state is:

$$I_{\text{CHRG(USBL)}} = \frac{200V}{R_{\text{ISET}}}$$

The LTC4077 can also program the wall adapter charge current and USB charge current independently using two program resistors,  $R_{\text{IDC}}$  and  $R_{\text{IUSB}}$ . Figure 3 shows a charger circuit that sets the wall adapter charge current to 800mA and the USB charge current to 500mA (HPWR = high) or 50mA (HPWR = low).

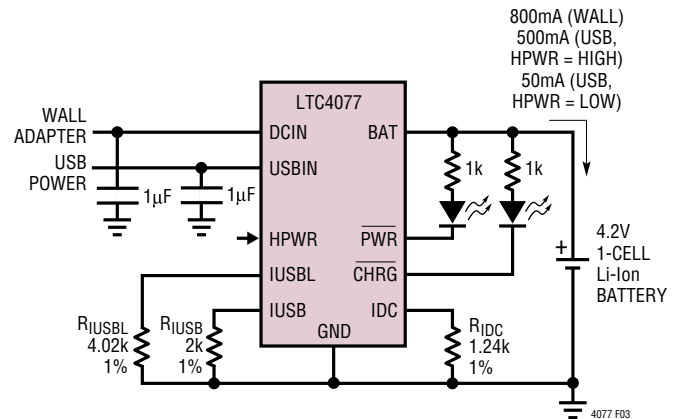

**Figure 3. Full Featured Dual Input Charger Circuit**

## APPLICATIONS INFORMATION

### Stability Considerations

The constant-voltage mode feedback loop is stable without any compensation provided a battery is connected to the charger output. However, a 1 $\mu$ F capacitor with a 1 $\Omega$  series resistor is recommended at the BAT pin to keep the ripple voltage low when the battery is disconnected.

When the charger is in constant-current mode, the charge current program pin (IDC, IUSB or IUSBL) is in the feedback loop, not the battery. The constant-current mode stability is affected by the impedance at the charge current program pin. With no additional capacitance on this pin, the charger is stable with program resistor values as high as 20k; however, additional capacitance on these nodes reduces the maximum allowed program resistor.

### Power Dissipation

When designing the battery charger circuit, it is not necessary to design for worst-case power dissipation scenarios because the LTC4077 automatically reduces the charge current during high power conditions. The conditions that cause the LTC4077 to reduce charge current through thermal feedback can be approximated by considering the power dissipated in the IC. Most of the power dissipation is generated from the internal MOSFET pass device, thus, the power dissipation is calculated to be:

$$P_D = (V_{IN} - V_{BAT}) \cdot I_{BAT}$$

$P_D$  is the power dissipated,  $V_{IN}$  is the input supply voltage (either DCIN or USBIN),  $V_{BAT}$  is the battery voltage and  $I_{BAT}$  is the charge current. The approximate ambient temperature at which the thermal feedback begins to protect the IC is:

$$T_A = 105^\circ\text{C} - P_D \cdot \theta_{JA}$$

$$T_A = 105^\circ\text{C} - (V_{IN} - V_{BAT}) \cdot I_{BAT} \cdot \theta_{JA}$$

Example: An LTC4077 operating from a 5V wall adapter (on the DCIN input) is programmed to supply 800mA full-scale current to a discharged Li-Ion battery with a voltage of 3.3V. Assuming  $\theta_{JA}$  is 40°C/W (see Thermal Considerations), the ambient temperature at which the LTC4077 will begin to reduce the charge current is approximately:

$$T_A = 105^\circ\text{C} - (5\text{V} - 3.3\text{V}) \cdot (800\text{mA}) \cdot 40^\circ\text{C}/\text{W}$$

$$T_A = 105^\circ\text{C} - 1.36\text{W} \cdot 40^\circ\text{C}/\text{W} = 105^\circ\text{C} - 54.4^\circ\text{C}$$

$$T_A = 50.6^\circ\text{C}$$

The LTC4077 can be used above 50.6°C ambient, but the charge current will be reduced from 800mA. The approximate current at a given ambient temperature can be approximated by:

$$I_{BAT} = \frac{105^\circ\text{C} \pm T_A}{(V_{IN} \pm V_{BAT}) \cdot \theta_{JA}}$$

Using the previous example with an ambient temperature of 60°C, the charge current will be reduced to approximately:

$$I_{BAT} = \frac{105^\circ\text{C} \pm 60^\circ\text{C}}{(5\text{V} \pm 3.3\text{V}) \cdot 40^\circ\text{C}/\text{W}} = \frac{45^\circ\text{C}}{68^\circ\text{C}/\text{A}}$$

$$I_{BAT} = 662\text{mA}$$

It is important to remember that LTC4077 applications do not need to be designed for worst-case thermal conditions, since the IC will automatically reduce power dissipation when the junction temperature reaches approximately 105°C.

## APPLICATIONS INFORMATION

### Thermal Considerations

In order to deliver maximum charge current under all conditions, it is critical that the exposed metal pad on the backside of the LTC4077 package is properly soldered to the PC board ground. When correctly soldered to a 2500mm<sup>2</sup> double sided 1oz copper board, the LTC4077 has a thermal resistance of approximately 40°C/W. Failure to make thermal contact between the exposed pad on the backside of the package and the copper board will result in thermal resistances far greater than 40°C/W. As an example, a correctly soldered LTC4077 can deliver over 800mA to a battery from a 5V supply at room temperature. Without a good backside thermal connection, this number would drop to much less than 500mA.

### Protecting the USB Pin and Wall Adapter Input from Overvoltage Transients

Caution must be exercised when using ceramic capacitors to bypass the USBIN pin or the wall adapter inputs. High voltage transients can be generated when the USB or wall

adapter is hot plugged. When power is supplied via the USB bus or wall adapter, the cable inductance along with the self resonant and high Q characteristics of ceramic capacitors can cause substantial ringing which could exceed the maximum voltage ratings and damage the LTC4077. Refer to Linear Technology Application Note 88, entitled “Ceramic Input Capacitors Can Cause Overvoltage Transients” for a detailed discussion of this problem.

**Always use an oscilloscope to check the voltage waveforms at the USBIN and DCIN pins during USB and wall adapter hot-plug events to ensure that overvoltage transients have been adequately removed.**

### Reverse Polarity Input Voltage Protection

In some applications, protection from reverse polarity voltage on the input supply pins is desired. If the supply voltage is high enough, a series blocking diode can be used. In other cases where the voltage drop must be kept low, a P-channel MOSFET can be used (as shown in Figure 4).

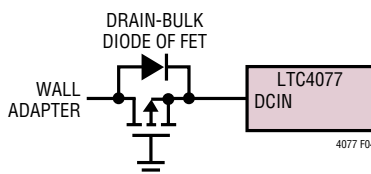
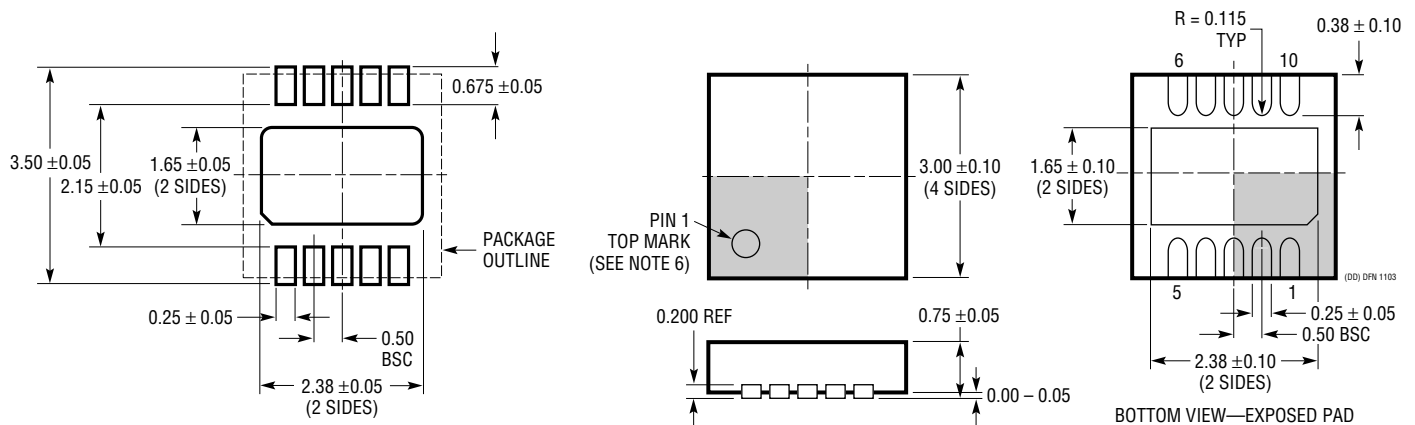

Figure 4. Low Loss Input Reverse Polarity Protection

## PACKAGE DESCRIPTION

### DD Package 10-Lead Plastic DFN (3mm × 3mm) (Reference LTC DWG # 05-08-1699)



#### RECOMMENDED SOLDER PAD PITCH AND DIMENSIONS

##### NOTE:

1. DRAWING TO BE MADE A JEDEC PACKAGE OUTLINE MO-229 VARIATION OF (WEED-2).  
CHECK THE LTC WEBSITE DATA SHEET FOR CURRENT STATUS OF VARIATION ASSIGNMENT
2. DRAWING NOT TO SCALE
3. ALL DIMENSIONS ARE IN MILLIMETERS
4. DIMENSIONS OF EXPOSED PAD ON BOTTOM OF PACKAGE DO NOT INCLUDE MOLD FLASH. MOLD FLASH, IF PRESENT, SHALL NOT EXCEED 0.15mm ON ANY SIDE
5. EXPOSED PAD SHALL BE SOLDER PLATED
6. SHADED AREA IS ONLY A REFERENCE FOR PIN 1 LOCATION ON THE TOP AND BOTTOM OF PACKAGE

**RELATED PARTS**

PART NUMBER	DESCRIPTION	COMMENTS
LTC3455	Dual DC/DC Converter with USB Power Management and Li-Ion Battery Charger	Efficiency >96%, Accurate USB Current Limiting (500mA/100mA), 4mm × 4mm QFN-24 Package
LTC4053	USB Compatible Monolithic Li-Ion Battery Charger	Standalone Charger with Programmable Timer, Up to 1.25A Charge Current
LTC4054/LTC4054X	Standalone Linear Li-Ion Battery Charger with Integrated Pass Transistor in ThinSOT	Thermal Regulation Prevents Overheating, C/10 Termination, C/10 Indicator, Up to 800mA Charge Current
LTC4055	USB Power Controller and Battery Charger	Charges Single-Cell Li-Ion Batteries Directly from USB Port, Thermal Regulation, 4mm × 4mm QFN-16 Package
LTC4058/LTC4058X	Standalone 950mA Lithium-Ion Charger in DFN	C/10 Charge Termination, Battery Kelvin Sensing, ±7% Charge Accuracy
LTC4061	Standalone Li-Ion Charger with Thermistor Interface	4.2V, ±0.35% Float Voltage, Up to 1A Charge Current, 3mm × 3mm DFN-10 Package
LTC4061-4.4	Standalone Li-Ion Charger with Thermistor Interface	4.4V, ±0.4% Float Voltage, Up to 1A Charge Current, 3mm × 3mm DFN-10 Package
LTC4062	Standalone Li-Ion Charger with Micropower Comparator	4.2V, ±0.35% Float Voltage, Up to 1A Charge Current, 3mm × 3mm DFN-10 Package
LTC4065/LTC4065A	Standalone 750mA Li-Ion Charger in 2mm × 2mm DFN	4.2V, ±0.6% Float Voltage, Up to 750mA Charge Current, 2mm × 2mm DFN-6 Package
LTC4066	USB Power Controller and Li-Ion Linear Battery Charger with Low-Loss Ideal Diode	Seamless Transition Between Input Power Sources: Li-Ion Battery, USB and Wall Adapter, Low-Loss (50Ω) Ideal Diode, 4mm × 4mm QFN-24 Package
LTC4068/LTC4068X	Standalone Linear Li-Ion Battery Charger with Programmable Termination	Charge Current up to 950mA, Thermal Regulation, 3mm × 3mm DFN-8 Package
LTC4075	Dual Input Standalone Li-Ion Battery Charger	Charges Single-Cell Li-Ion Batteries from Wall Adapter and USB Inputs with Automatic Input Power Detection and Selection, 950mA Charger Current, Thermal Regulation, C/X Charge Termination, 3mm × 3mm DFN Package
LTC4076	Dual Input Standalone Li-Ion Battery Charger	Charges Single-Cell Li-Ion Batteries from Wall Adapter and USB Inputs with Automatic Input Power Detection and Selection, 950mA Charger Current, Thermal Regulation, C/X Charge Termination, 3mm × 3mm DFN Package
LTC4410	USB Power Manager and Battery Charger	Manages Total Power Between a USB Peripheral and Battery Charger, Ultralow Battery Drain: 1μA, ThinSOT™ Package
LTC4411/LTC4412	Low Loss PowerPath™ Controller in ThinSOT	Automatic Switching Between DC Sources, Load Sharing, Replaces ORing Diodes

ThinSOT and PowerPath are trademarks of Linear Technology Corporation.