

## CW-RCS Series 915 MHz Right-Angle Whip Antenna

The ANT-916-CW-RCS antenna is designed for sub-1 GHz and low-power, wide-area (LPWA) applications including LoRaWAN® and ISM band applications in the 902 MHz to 930 MHz band.

The right-angle rotating design of the ANT-916-CW-RCS antenna allows for the antenna to be positioned for optimum performance.

The ANT-916-CW-RCS is available with an SMA plug (male pin) or RP-SMA plug (female socket) connector.



ANT-916-CW-RCS-SMA shown

### Features

- Performance at 902 MHz to 930 MHz
  - VSWR:  $\leq 2.0$
  - Peak Gain: 4.8 dBi
  - Efficiency: 69%
- Compact size
  - 54.0 mm x  $\varnothing$ 9.4 mm
- Rotating base allows for optimal positioning
- SMA plug (male pin) or RP-SMA plug (female socket)

### Applications

- Low-power, wide-area (LPWA) applications
  - LoRaWAN®, ITU-T Y.4480
- ISM applications
- Remote control, sensing and monitoring
  - Security systems
  - Industrial machinery
  - Automated equipment
  - AMR (automated meter reading)
- Internet of Things (IoT) devices
- Smart Home networking

### Ordering Information

Part Number	Description
ANT-916-CW-RCS-SMA	915 MHz right-angle whip antenna with SMA plug (male pin)
ANT-916-CW-RCS	915 MHz right-angle whip antenna with RP-SMA plug (female socket)

Available from Linx Technologies and select distributors and representatives.

Table 1. Electrical Specifications

Parameter	Value		
Frequency Range	902 MHz to 930 MHz		
VSWR (max)	2.0		
Peak Gain (dBi)	4.8		
Average Gain (dBi)	-1.7		
Efficiency (%)	69		
Polarization	Linear	Radiation	Omnidirectional
Impedance	50 Ω	Max Power	5 W
Wavelength	1/4-wave	Electrical Type	Monopole

Electrical specifications and plots measured with a 102 mm x 102 mm (4.0 in x 4.0 in) reference ground plane.

Table 2. Mechanical Specifications

Parameter	Value
Connection	SMA plug (male pin), RP-SMA plug (female socket)
Dimensions	54.0 mm x Ø9.4 mm (2.13 in x Ø0.37 in)
Weight	8.4 g (0.30 oz)
Operating Temp. Range	-20 °C to +85 °C

Product Dimensions

Figure 1 provides dimensions for the ANT-916-CW-RCS-ccc series antenna.

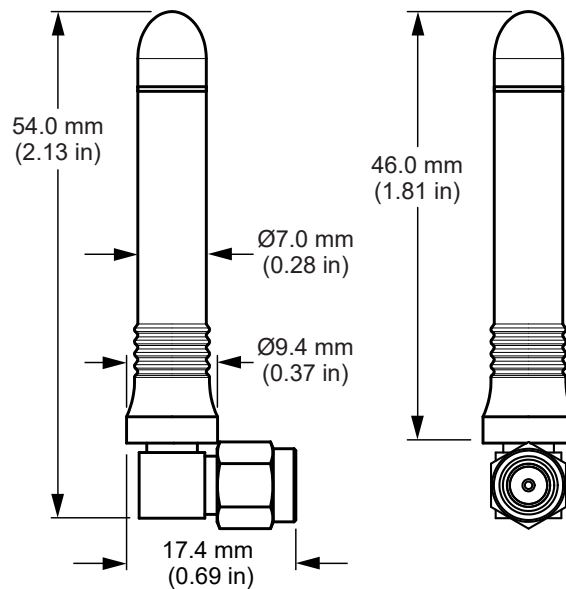

Figure 1. ANT-916-CW-RCS-ccc Antenna Dimensions

Packaging Information

The ANT-916-CW-RCS series antenna is individually packaged in a sealed plastic bag in quantities of 100 pcs. Bags are packaged in cartons. Distribution channels may offer alternative packaging options.

## Counterpoise

Quarter-wave or monopole antennas require an associated ground plane counterpoise for proper operation. The size and location of the ground plane relative to the antenna will affect the overall performance of the antenna in the final design. When used in conjunction with a ground plane smaller than that used to tune the antenna, the center frequency typically will shift higher in frequency and the bandwidth will decrease. The proximity of other circuit elements and packaging near the antenna will also affect the final performance.

For further discussion and guidance on the importance of the ground plane counterpoise, please refer to Linx Application Note, *AN-00501: Understanding Antenna Specifications and Operation*.

## Antenna Orientation

The ANT-916-CW-RCS-ccc antenna is characterized at the edge of a ground plane as shown in Figure 2. Characterization at the edge of the ground plane (102 mm x 102 mm) provides insight into antenna performance when attached to a connector on a metal enclosure. The two orientations represent the most common end-product use case.

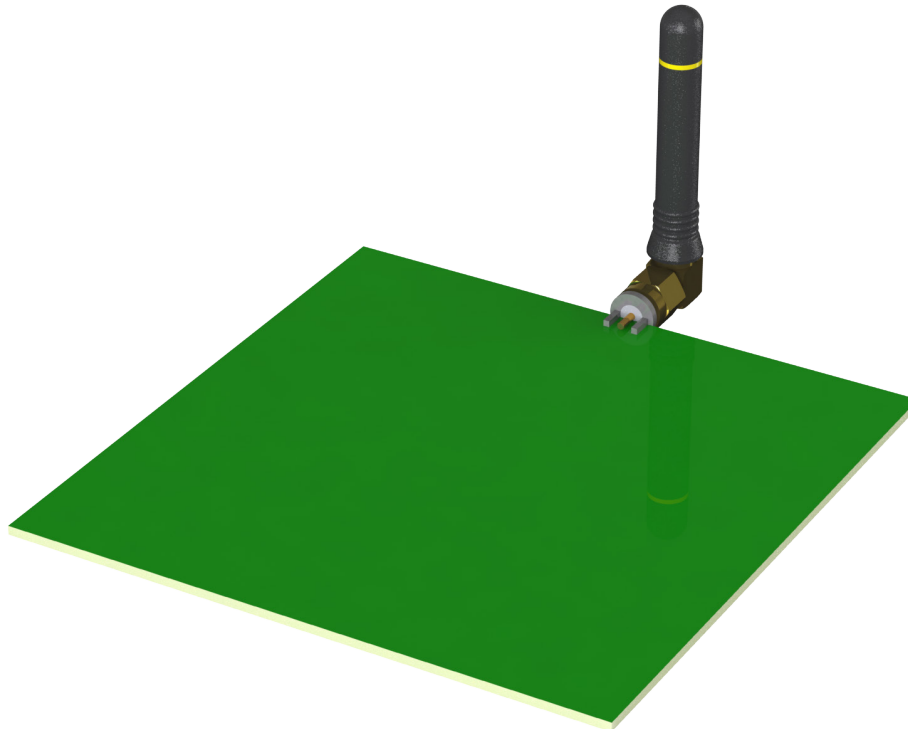

Figure 2. ANT-916-CW-RCS-ccc Test Orientation

### VSWR

Figure 3 provides the voltage standing wave ratio (VSWR) across the antenna bandwidth. VSWR describes the power reflected from the antenna back to the radio. A lower VSWR value indicates better antenna performance at a given frequency. Reflected power is also shown on the right-side vertical axis as a gauge of the percentage of transmitter power reflected back from the antenna.

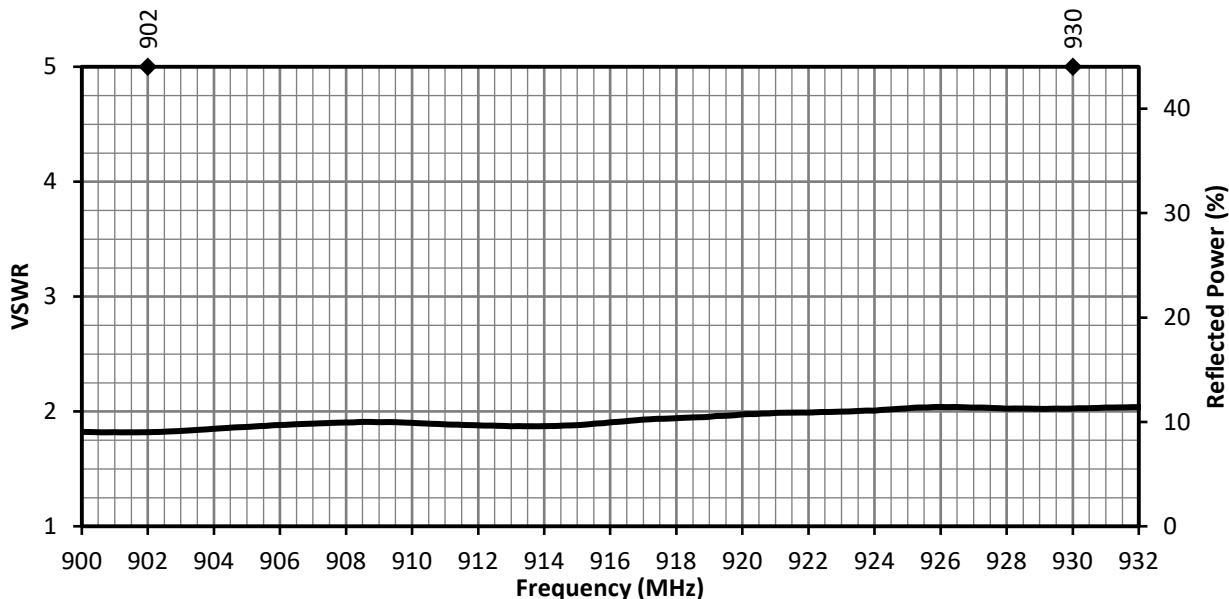

Figure 3. ANT-916-CW-RCS-ccc Antenna VSWR

### Return Loss

Return loss (Figure 4), represents the loss in power at the antenna due to reflected signals. Like VSWR, a lower return loss value indicates better antenna performance at a given frequency.

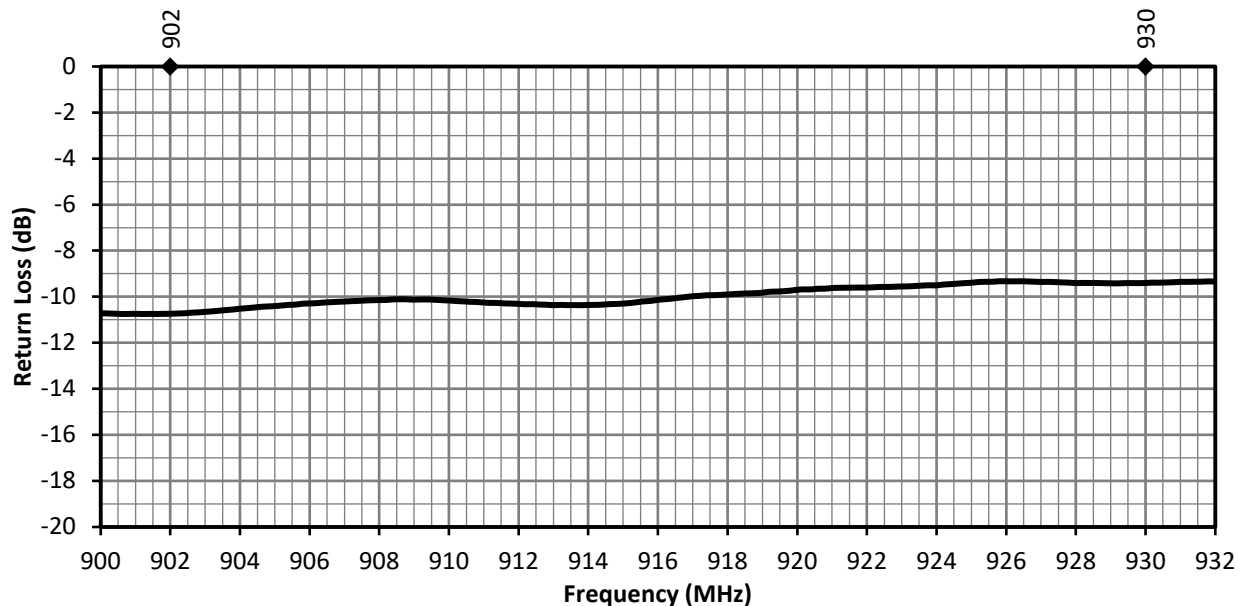

Figure 4. ANT-916-CW-RCS-ccc Return Loss

### Peak Gain

The peak gain across the antenna bandwidth is shown in Figure 5. Peak gain represents the maximum antenna input power concentration across 3-dimensional space, and therefore peak performance at a given frequency, but does not consider any directionality in the gain pattern.

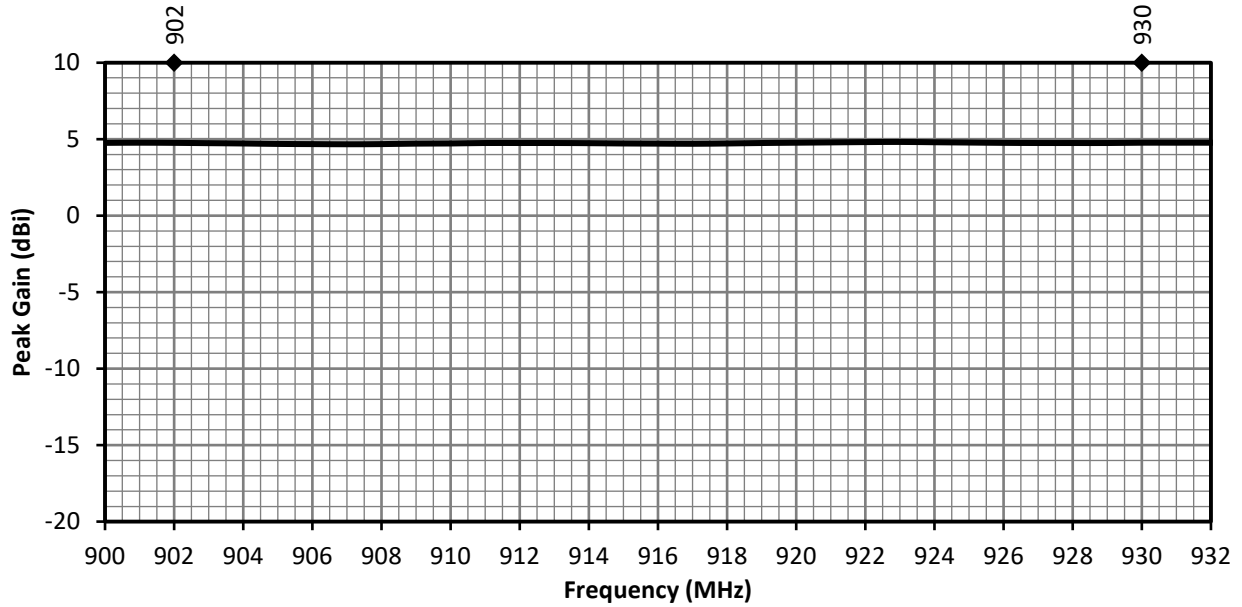

Figure 5. ANT-916-CW-RCS-ccc Peak Gain

### Average Gain

Average gain (Figure 6), is the average of all antenna gain in 3-dimensional space at each frequency, providing an indication of overall performance without expressing antenna directionality.

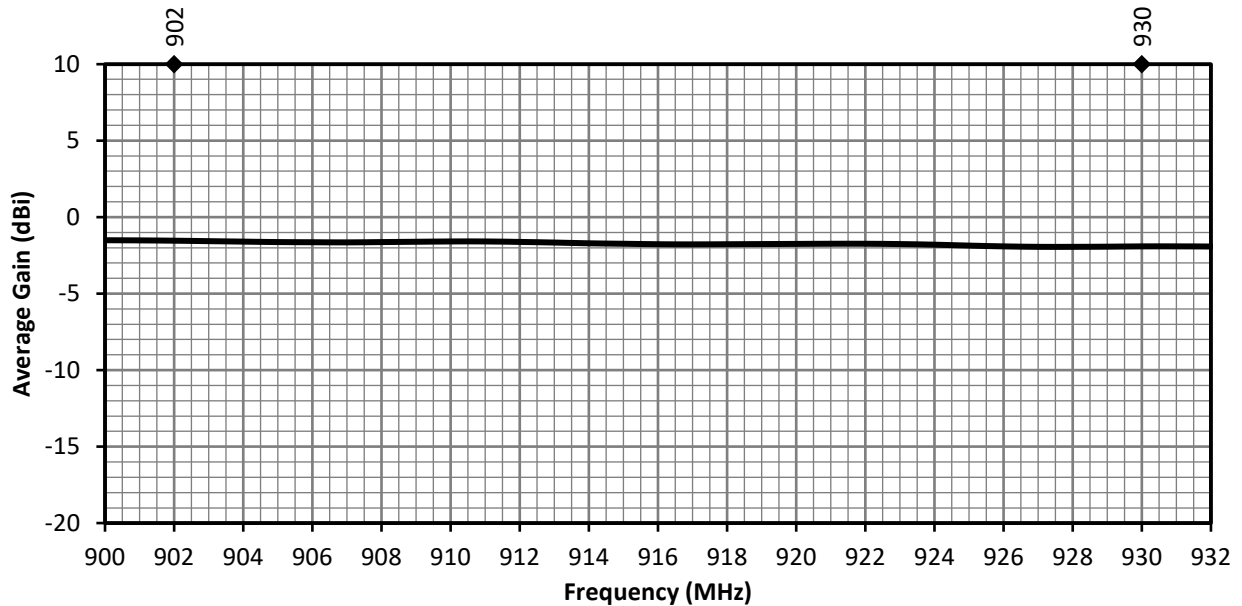

Figure 6. ANT-916-CW-RCS-ccc Antenna Average Gain

### Radiation Efficiency

Radiation efficiency (Figure 7), shows the ratio of power delivered to the antenna relative to the power radiated at the antenna, expressed as a percentage, where a higher percentage indicates better performance at a given frequency.

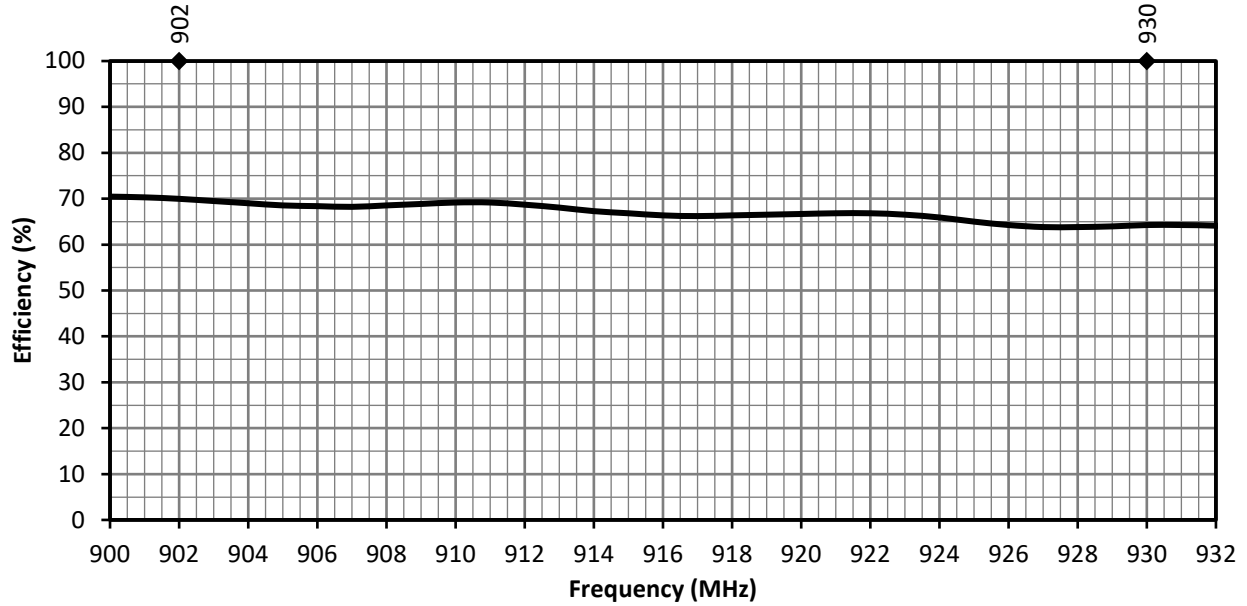
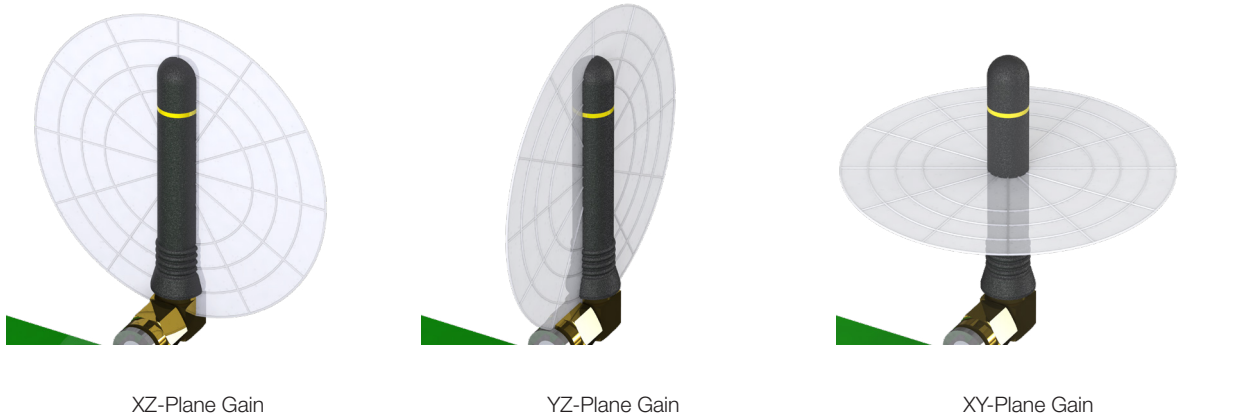

Figure 7. ANT-916-CW-RCS-ccc Antenna Radiation Efficiency

### Radiation Patterns

Radiation patterns provide information about the directionality and 3-dimensional gain performance of the antenna by plotting gain at specific frequencies in three orthogonal planes. Antenna radiation patterns are shown in Figure 8 using polar plots covering 360 degrees. The antenna graphic at the top of the page provides reference to the plane of the column of plots below it. Note: when viewed with typical PDF viewing software, zooming into radiation patterns is possible to reveal fine detail.



### 902 MHz to 930 MHz (915 MHz)

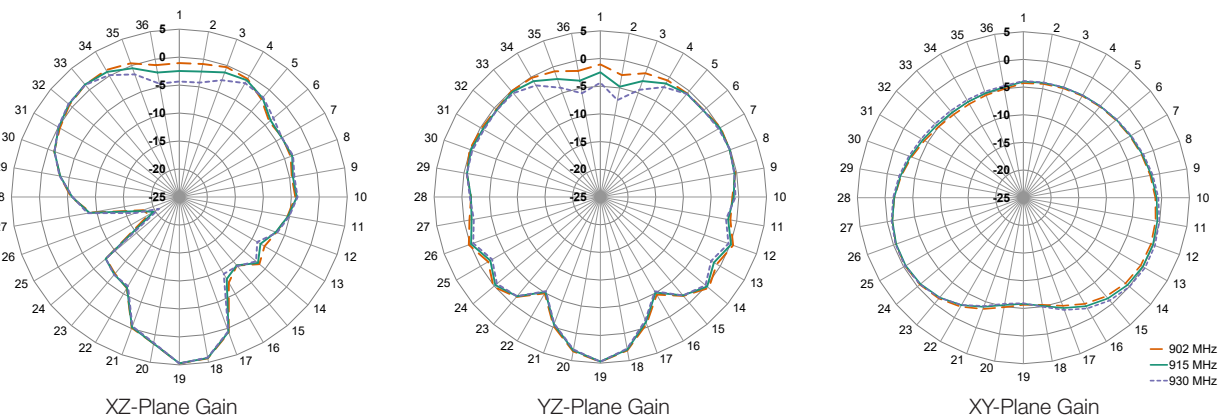

Figure 8. ANT-916-CW-RCS-ccc Radiation Patterns

---

**Website:** <http://linxtechnologies.com>  
**Linx Offices:** 159 Ort Lane, Merlin, OR, US 97532  
**Phone:** +1 (541) 471-6256  
**E-MAIL:** [info@linxtechnologies.com](mailto:info@linxtechnologies.com)

---

Linx Technologies reserves the right to make changes to the product(s) or information contained herein without notice. No liability is assumed as a result of their use or application. No rights under any patent accompany the sale of any such product(s) or information.

Wireless Made Simple is a registered trademark of Linx Acquisitions LLC. LoRaWAN is a registered trademark of Semtech Corporation. Other product and brand names may be trademarks or registered trademarks of their respective owners.

Copyright © 2022 Linx Technologies

All Rights Reserved

Doc# DS22170-247ANT

