

NON-ISOLATED DC/DC CONVERTERS

3 Vdc – 14.4 Vdc Input, 0.6 Vdc - 5.5 Vdc /20 A Outputs



Jul. 14, 2015

Bel Power Inc., a subsidiary of Bel Fuse Inc.

SLAN-20D1Ax

RoHS Compliant

Rev.B

Features

- Non-Isolated
- Power Good signal
- Remote On/Off
- Over temperature protection
- Compliant to IPC-9592 (September 2008), Category 2, Class II
- Compliant to RoHS EU Directive 2002/95/EC
- Compatible in a Pb-free or SnPb reflow environment
- Output voltage programmable from 0.6Vdc to 5.5Vdc via external resistor.
- Tunable Loop™ to optimize dynamic output voltage response
- Output overcurrent protection (non-latching)
- Wide operating temperature range [-40°C to 85°C]
- Wide Input voltage range (3Vdc-14.4Vdc).
- UL60950-1 Recognized (UL/cUL)
- Small size:20.32mm×11.43mm×8.5mm(0.8 in×0.45 in×0.334 in)
- ISO 9001 and ISO 14001 certified manufacturing facilities
- Cost efficient open frame design
- Ability to sink and source current
- DOSA based
- Fixed switching frequency

Applications

- Distributed power architectures
- Intermediate bus voltage applications
- Telecommunications equipment
- Servers and storage applications
- Networking equipment
- Industrial equipment



Description

The SLAN-20D1Ax modules are non-isolated dc-dc converters that can deliver up to 20A of output current. These modules operate over a wide range of input voltage ($V_{IN} = 3Vdc-14.4Vdc$) and provide a precisely regulated output voltage from 0.6Vdc to 5.5Vdc, programmable via an external resistor. Features include remote On/Off, adjustable output voltage, over current and over temperature protection. The Tunable Loop™ feature allows the user to optimize the dynamic response of the converter to match the load with reduced amount of output capacitance leading to savings on cost and PWB area.

Part Selection

Output Voltage	Input Voltage	Max. Output Current	Max. Output Power	Typical Efficiency	Model Number Active High	Model Number Active Low
0.6 - 5.5 Vdc	3 - 14.4 Vdc	20 A	110W	95.2%	SLAN-20D1A0	SLAN-20D1AL

- Notes:** 1. Add "R" suffix at the end of the model number to indicate tape and reel packaging (Standard).
2. Add "G" suffix at the end of the model number to indicate tray packaging (Option).

NON-ISOLATED DC/DC CONVERTERS

3 Vdc – 14.4 Vdc Input, 0.6 Vdc - 5.5 Vdc /20 A Outputs



Jul. 14, 2015

Bel Power Inc., a subsidiary of Bel Fuse Inc.

Ordering Part Number

S LAN – 20 D 1A 0 x
1 2 3 4 5 6 7

1---Surface mount

2---Series code

3---Output current (20A)

4---Wide input voltage range (3-14.4V)

5---With sequencing

6---Enable, active high, change “0” to “L” means active low

7---Package

Absolute Maximum Ratings

Parameter	Min	Max	Unit	Notes
Continuous Input Voltage	-0.3	15	V	
SEQ, SYNC, VS+	-	7	V	
Operating Ambient Temperature	-40	85	°C	see Thermal Considerations section
Storage Temperature	-55	125	°C	
Altitude	-	2000	m	

Note: Stresses in excess of the absolute maximum ratings can cause permanent damage to the device. These are absolute stress ratings only, functional operation of the device is not implied at these or any other conditions in excess of those given in the operations sections of the data sheet. Exposure to absolute maximum ratings for extended periods can adversely affect the device reliability.

Input Specifications

Parameter	Min	Typ	Max	Unit	Notes	
Operating Input Voltage	3	-	14.4	V		
Input Current (full load)	-	-	19	A	$V_{IN}=4.5V$ to $14V$, $I_O=I_{Omax}$	
Input Current (no load)	-	69	-	mA	$V_{O,set} = 0.6$ Vdc	$V_{IN} = 12Vdc$, $I_O = 0$, module enabled
	-	134	-	mA	$V_{O,set} = 5$ Vdc	
Input Stand-by Current	-	16.4	-	mA	$V_{IN} = 12V$, module disabled	
Input Reflected Ripple Current (pk-pk)	-	50	-	mAp-p	5Hz to 20MHz, 1 μ H source impedance; $V_{IN} = 0$ to $14V$, $I_O = I_{Omax}$; See Test Configurations	
I ² t Inrush Current Transient	-	-	1	A ² s		
Input Ripple Rejection (120Hz)	-	-64	-	dB		

Note: Unless otherwise indicated, specifications apply over all operating input voltage, resistive load, and temperature conditions.

Output Specifications

Parameter	Min	Typ	Max	Unit	Notes
Output Voltage Set Point	-1.0	-	+1.0	% $V_{O,set}$	with 0.1% tolerance for external resistor used to set output voltage
Output Voltage	-3.0	-	+3.0	% $V_{O,set}$	Over all operating input voltage, resistive load, and temperature conditions until end of life
Adjustment Range	0.6	-	5.5	V	1.selected by an external resistor 2.Some output voltages may not be possible depending on the input voltage – see Feature Descriptions Section
Remote Sense Range	-	-	0.5	V	
Load Regulation	$V_O \geq 2.5V$	-	10	mV	$I_O=I_{O, min}$ to $I_{O, max}$
	$V_O < 2.5V$	-	10	mV	

NON-ISOLATED DC/DC CONVERTERS

3 Vdc – 14.4 Vdc Input, 0.6 Vdc - 5.5 Vdc /20 A Outputs



Jul. 14, 2015

Bel Power Inc., a subsidiary of Bel Fuse Inc.

Output Specifications (continued)

Parameter	Min	Typ	Max	Unit	Notes
Line Regulation VO ≥ 2.5V VO < 2.5V	- -	- -	0.4 5	%V _{o,set} mV	V _{IN} =V _{IN, min} to V _{IN, max}
Temperature Regulation	-	-	0.4	%V _{o,set}	T _{ref} =T _{A, min} to T _{A, max}
Ripple and Noise (pk-pk)	-	50	100	mV	5Hz to 20MHz BW, V _{IN} =V _{IN, nom} and I _O =I _{O, min} to I _{O, max} Co = 0.1µF // 22 µF ceramic capacitors)
Ripple and Noise (rms)	-	20	38	mV	
Output Short-Circuit Current	-	1.4	-	A	V _o ≤250mV, Hiccup Mode
Output Capacitance ¹ ESR ≥ 1 mΩ ESR ≥ 0.15 mΩ ESR ≥ 10 mΩ	2x47 2x47 2x47	- - -	2x47 1000 10000	µF µF µF	Without the Tunable Loop™ With the Tunable Loop™ With the Tunable Loop™
Output Current	0	-	20	A	In either sink or source mode
Output Current Limit Inception	-	130	-	% I _{o,max}	1. Hiccup Mode 2. Current limit does not operate in sink mode
Output voltage overshoot	-	-	3.0	%V _{o, set}	V _{in} = V _{in, min} to V _{in, max} , I _o = I _{o, min} to I _{o, max} , T _A =25°C
Turn-On Delay Times (V _{IN} =V _{IN, nom} , I _O =I _{O, max} , V _O to within ±1% of steady state)	-	1.2	-	msec	Case 1: On/Off input is enabled and then input power is applied (delay from instant at which V _{IN} = V _{IN, min} until V _O = 10% of V _{o, set})
	-	0.8	-	msec	Case 2: Input power is applied for at least one second and then the On/Off input is enabled (delay from instant at which Von/Off is enabled until V _O = 10% of V _{o, set})
Output voltage Rise time	-	2.7	-	msec	Time for V _o to rise from 10% of V _{o, set} to 90% of V _{o, set} .

Notes: ¹ External capacitors may require using the new Tunable Loop™ feature to ensure that the module is stable as well as getting the best transient response. See the Tunable Loop™ section for details.

General Specifications

Parameter	Min	Typ	Max	Unit	Notes
Efficiency Vo=0.6V Vo=1.2V Vo=1.8V Vo=2.5V Vo=3.3V Vo=5.0V	- - - - - -	- - - - - -	79.2 87.1 90.4 92.6 93.8 95.2	% % % % % %	V _{in} = 12Vdc, T _A =25°C I _o =I _{o, max} , V _O = V _{o,set}
Switching Frequency	-	500	-	kHz	
Synchronization Frequency Range	425	-	600	kHz	
High-Level Input Voltage	2.0	-	-	V	
Low-Level Input Voltage	-	-	0.4	V	
Input Current, SYNC			100	nA	
Minimum Pulse Width, SYNC	100	-	-	ns	
Maximum SYNC rise time	100	-	-	ns	
Over Temperature Protection	-	120	-	°C	See Thermal Considerations section

NON-ISOLATED DC/DC CONVERTERS

3 Vdc – 14.4 Vdc Input, 0.6 Vdc - 5.5 Vdc /20 A Outputs



Jul. 14, 2015

Bel Power Inc., a subsidiary of Bel Fuse Inc.

General Specifications(continued)

Parameter	Min	Typ	Max	Unit	Notes
Tracking Accuracy Power-Up: 2V/ms Power-Down: 2V/ms	- -	- -	100 100	mV mV	$V_{IN, min}$ to $V_{IN, max}$; $I_{O, min}$ to $I_{O, max}$ $V_{SEQ} < V_O$
PGOOD (Power Good) Overvoltage threshold for PGOOD ON Overvoltage threshold for PGOOD OFF Undervoltage threshold for PGOOD ON Undervoltage threshold for PGOOD OFF Pulldown resistance of PGOOD pin	- - - - -	108 110 92 90 -	- - - - 50	% $V_{O, set}$. % $V_{O, set}$. % $V_{O, set}$. % $V_{O, set}$. Ω	Signal Interface Open Drain, $V_{supply} \leq 5VDC$
Input Undervoltage Lockout Turn-on Threshold Turn-off Threshold Hysteresis	- 2.6 -	- - 0.25	3.25 - -	V V V	
Weight	4.54			g	
MTBF	15,455,614			hours	Calculated MTBF ($I_O=0.8I_{O, max}$, $T_A=40^\circ C$) Telecordia Issue 2 Method 1 Case 3
Dimensions Inches (L x W x H) Millimeters (L x W x H)	0.80 x 0.45 x 0.334 20.32 x 11.43 x 8.5			-	

Note: Unless otherwise indicated, specifications apply over all operating input voltage, resistive load, and temperature conditions.

NON-ISOLATED DC/DC CONVERTERS

3 Vdc – 14.4 Vdc Input, 0.6 Vdc - 5.5 Vdc /20 A Outputs



Jul. 14, 2015
Efficiency Data

Bel Power Inc., a subsidiary of Bel Fuse Inc.

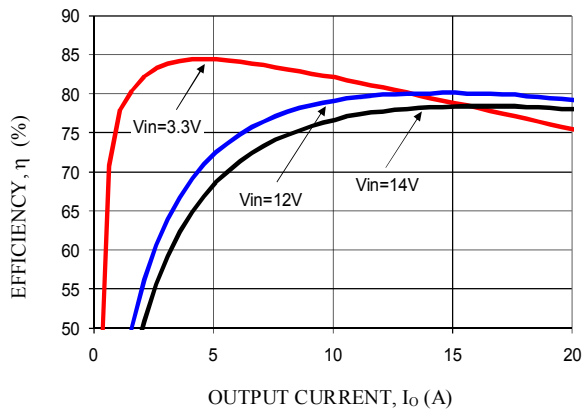

$V_o=0.6V$

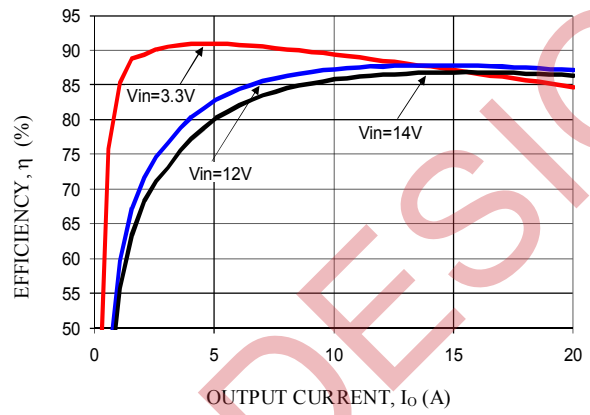

$V_o=1.2V$

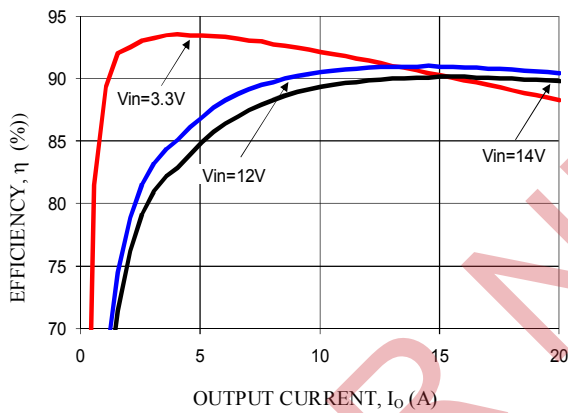

$V_o=1.8V$

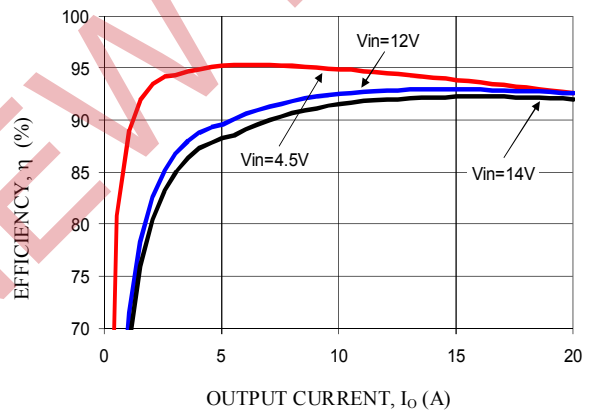

$V_o=2.5V$

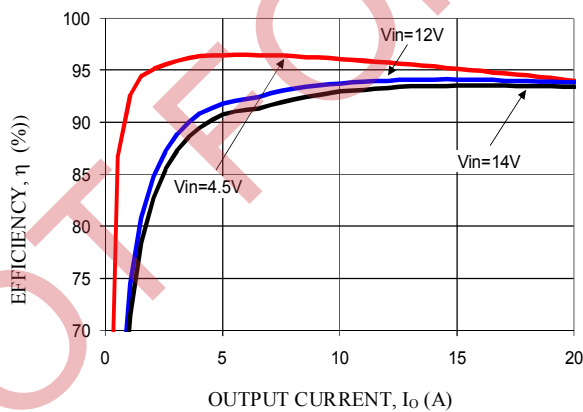

$V_o=3.3V$

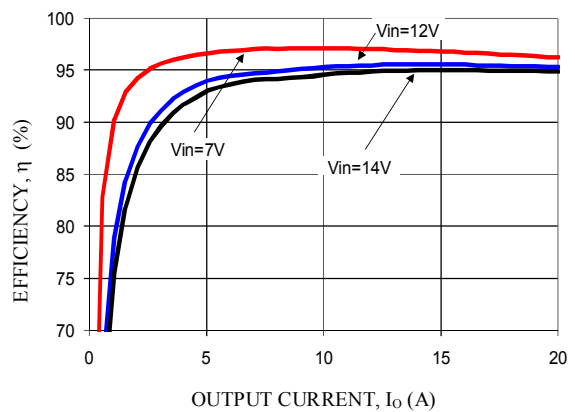

$V_o=5.0V$

NON-ISOLATED DC/DC CONVERTERS

3 Vdc – 14.4 Vdc Input, 0.6 Vdc - 5.5 Vdc /20 A Outputs



Jul. 14, 2015

Bel Power Inc., a subsidiary of Bel Fuse Inc.

Thermal Derating Curves

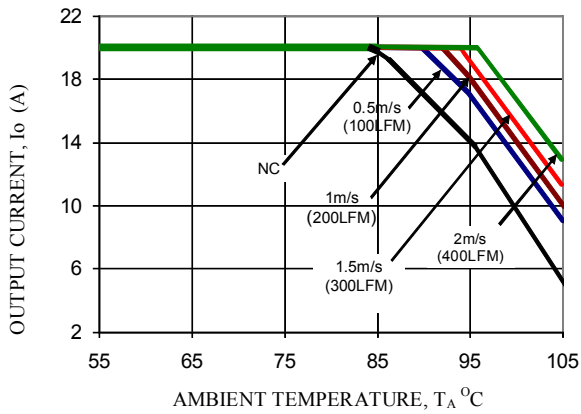

$V_o=0.6V$

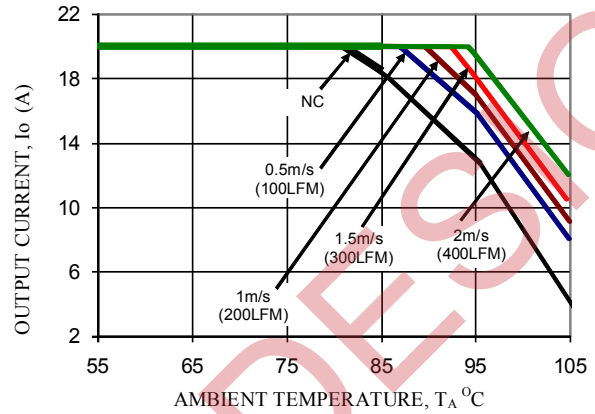

$V_o=1.2V$

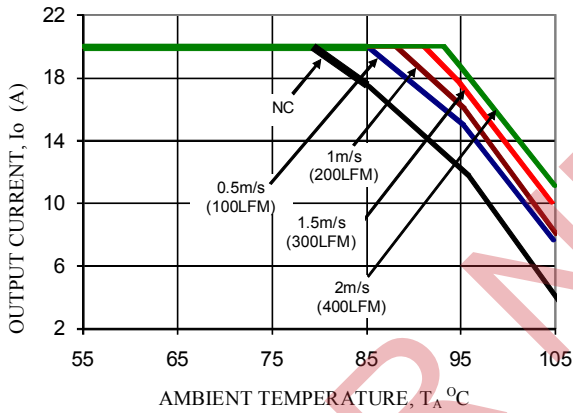

$V_o=1.8V$

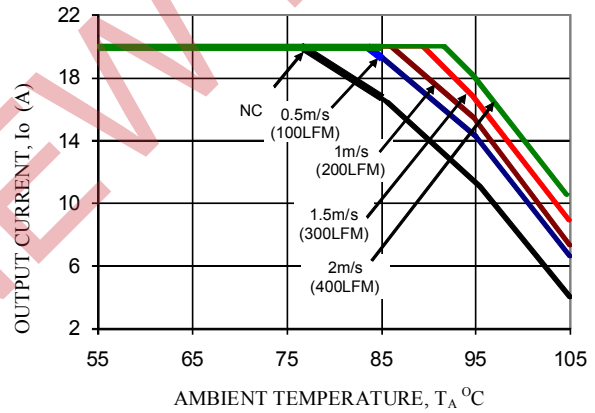

$V_o=2.5V$

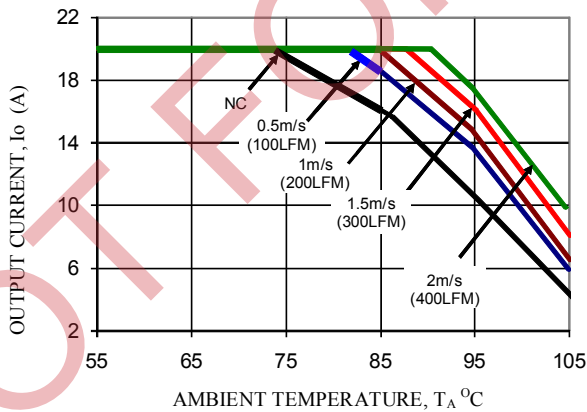

$V_o=3.3V$

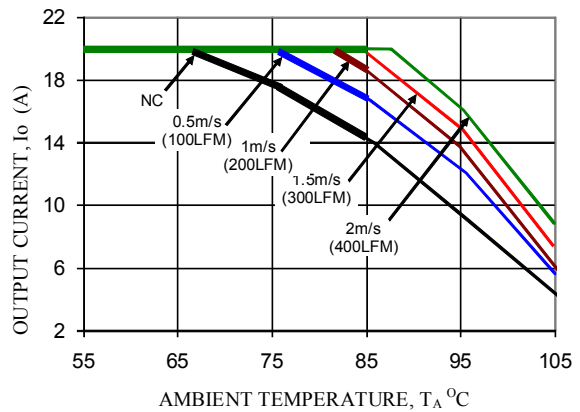

$V_o=5.0V$

NON-ISOLATED DC/DC CONVERTERS

3 Vdc – 14.4 Vdc Input, 0.6 Vdc - 5.5 Vdc /20 A Outputs



Jul. 14, 2015

Bel Power Inc., a subsidiary of Bel Fuse Inc.

Output ripple and Noise Waveforms

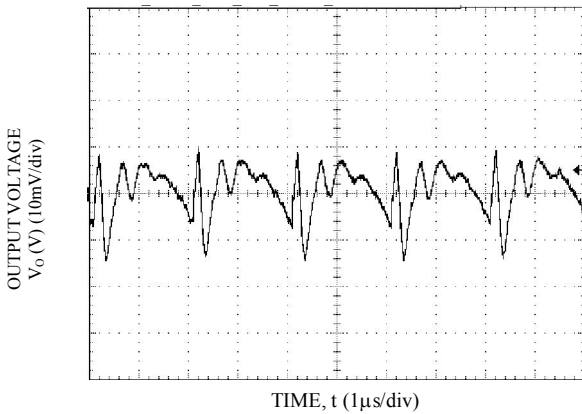

Vo=0.6V, Io = Io,max, Vin=12V

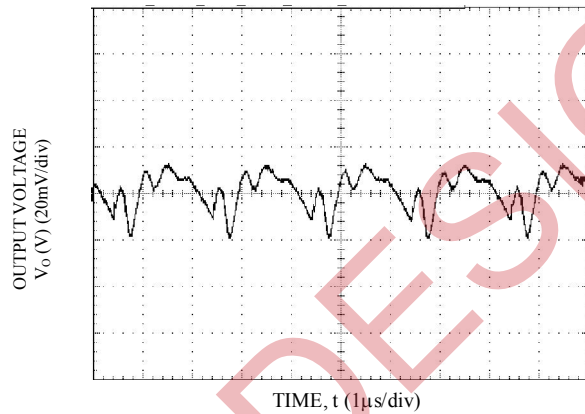

Vo=1.2V, Io = Io,max, Vin=12V

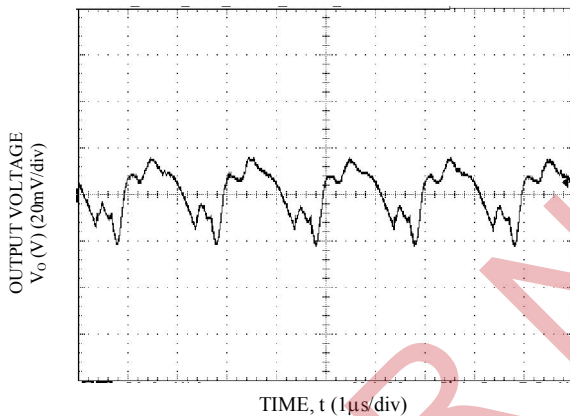

Vo=1.8V, Io = Io,max, Vin=12V

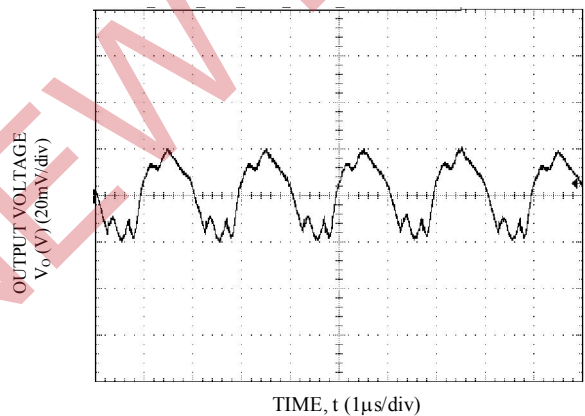

Vo=2.5V, Io = Io,max, Vin=12V

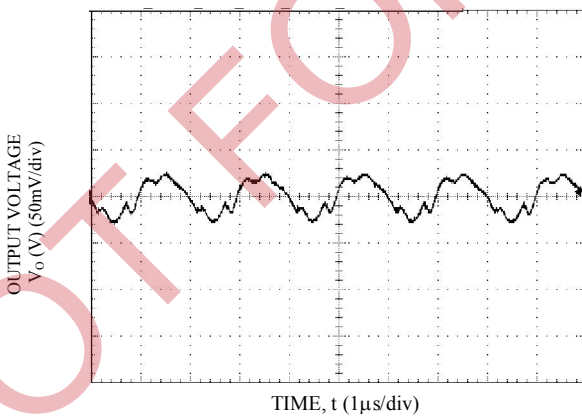

Vo=3.3V, Io = Io,max, Vin=12V

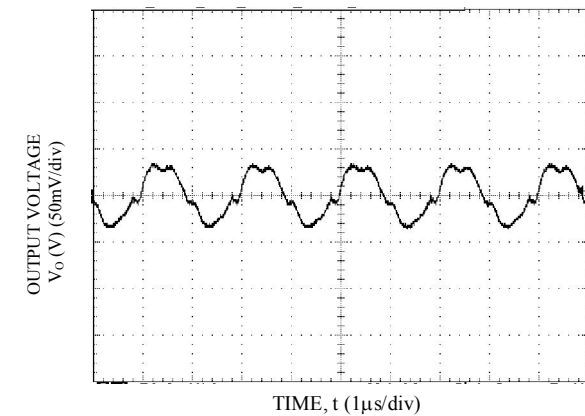

Vo=5.0V, Io = Io,max, Vin=12V

Note: $C_O=2 \times 47\mu\text{F}$ ceramic

NON-ISOLATED DC/DC CONVERTERS

3 Vdc – 14.4 Vdc Input, 0.6 Vdc - 5.5 Vdc /20 A Outputs



Jul. 14, 2015

Bel Power Inc., a subsidiary of Bel Fuse Inc.

Transient Response Waveforms

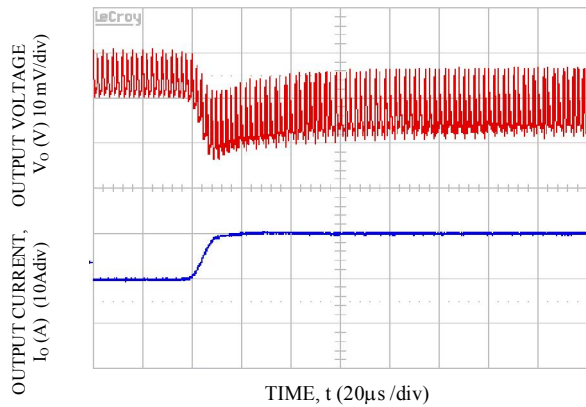

Transient Response to Dynamic Load Change from 50% to 100% at 12Vin, Cout= 1x47uF +11x330uF
CTune=47nF, RTune=178 ohms . Vo=0.6V

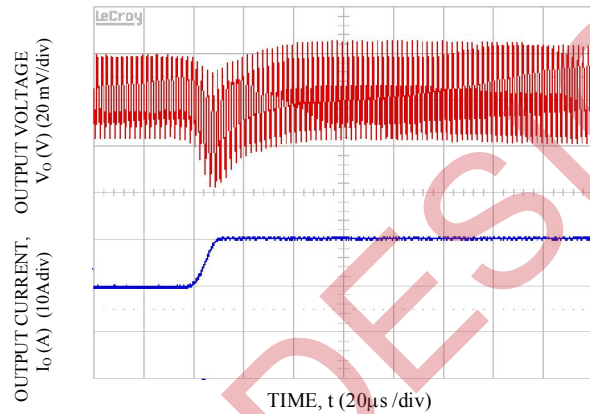

Transient Response to Dynamic Load Change from 50% to 100% at 12Vin, Cout= 1x47uF +5x330uF,
CTune=10nF & RTune=178 ohms . Vo=1.2V

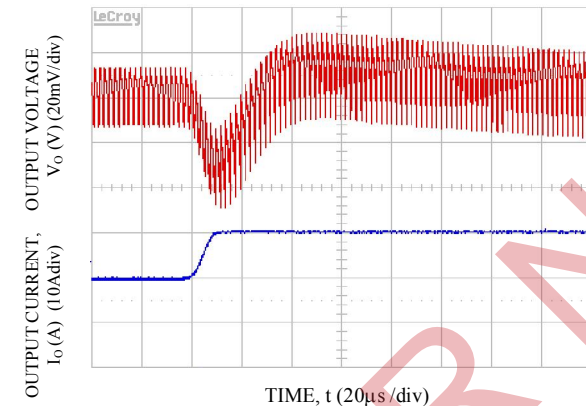

Transient Response to Dynamic Load Change from 50% to 100% at 12Vin, Cout= 2x47uF +3x330uF,
CTune=5600pF & RTune=220 ohms . Vo=1.8V

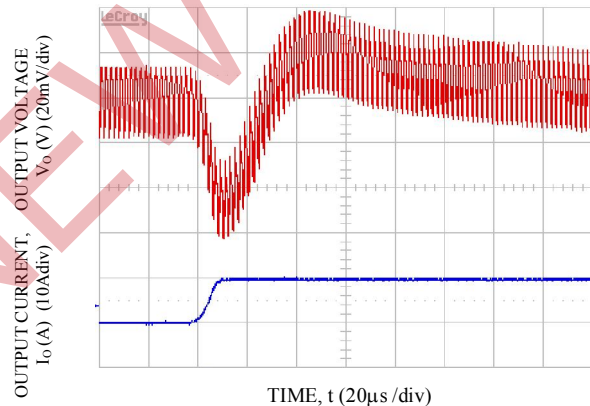

Transient Response to Dynamic Load Change from 50% to 100% at 12Vin, Cout= 2x47uF +2x330uF,
CTune=3300pF & RTune=220 ohms . Vo=2.5V

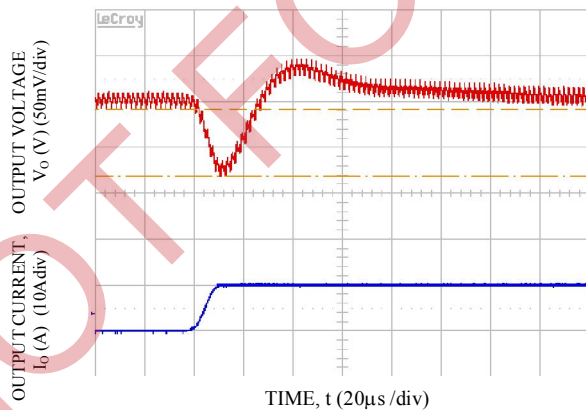

Transient Response to Dynamic Load Change from 50% to 100% at 12Vin, Cout= 5x47uF +1x330uF,
CTune=2200pF & RTune=220 ohms . Vo=3.3V

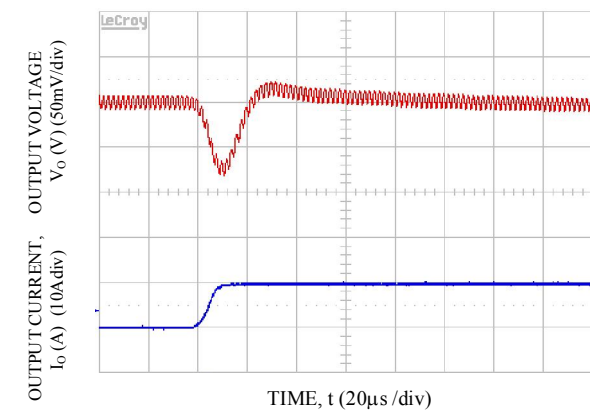

Transient Response to Dynamic Load Change from 50% to 100% at 12Vin, Cout= 8x47uF, CTune=1500pF
& RTune=220 ohms . Vo=5.0V

NON-ISOLATED DC/DC CONVERTERS

3 Vdc – 14.4 Vdc Input, 0.6 Vdc - 5.5 Vdc /20 A Outputs



Jul. 14, 2015

Bel Power Inc., a subsidiary of Bel Fuse Inc.

Startup Time

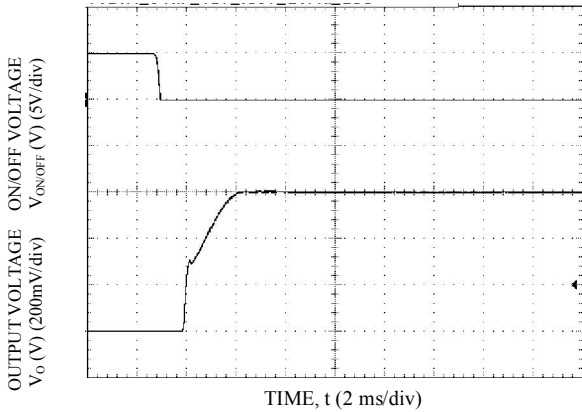

Start-up Using On/Off Voltage ($I_o = I_{o,max}$), $V_o=0.6V$

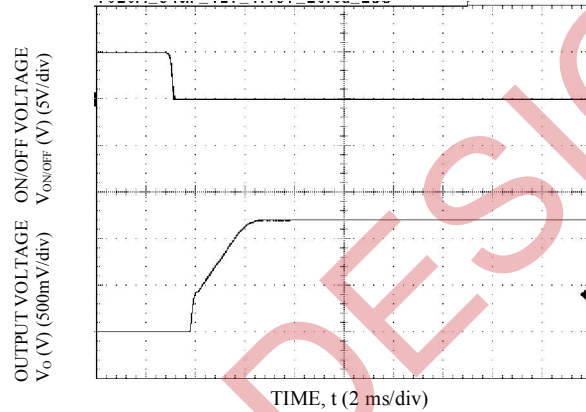

Start-up Using On/Off Voltage ($I_o = I_{o,max}$), $V_o=1.2V$

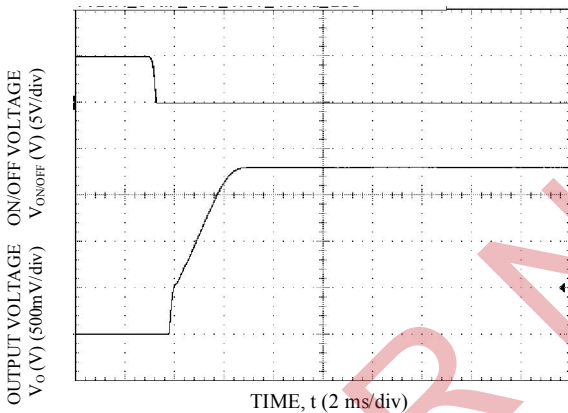

Start-up Using On/Off Voltage ($I_o = I_{o,max}$), $V_o=1.8V$

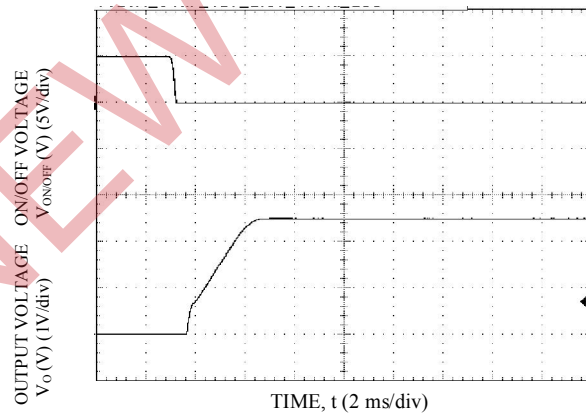

Start-up Using On/Off Voltage ($I_o = I_{o,max}$), $V_o=2.5V$

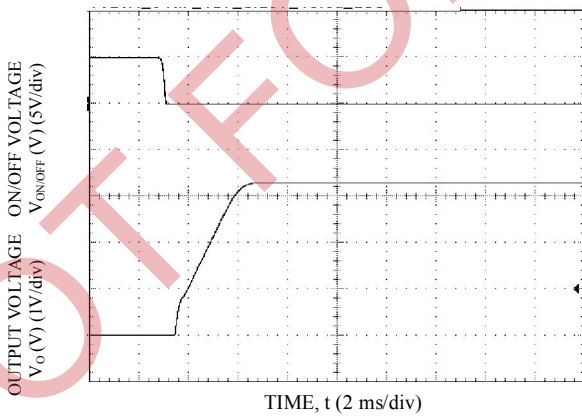

Start-up Using On/Off Voltage ($I_o = I_{o,max}$), $V_o=3.3V$

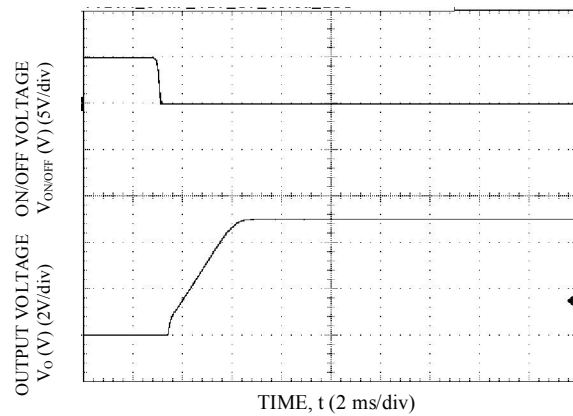

Start-up Using On/Off Voltage ($I_o = I_{o,max}$), $V_o=5.0V$

NON-ISOLATED DC/DC CONVERTERS

3 Vdc – 14.4 Vdc Input, 0.6 Vdc - 5.5 Vdc /20 A Outputs



Jul. 14, 2015

Bel Power Inc., a subsidiary of Bel Fuse Inc.

Startup Time (continued)

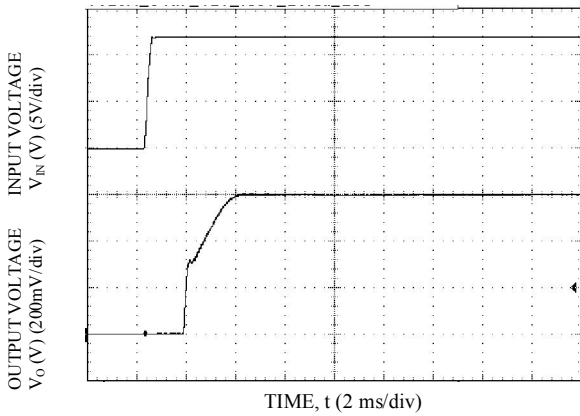

Start-up Using Input Voltage ($V_{IN} = 12V$, $I_o = I_{o,max}$), $V_o=0.60V$

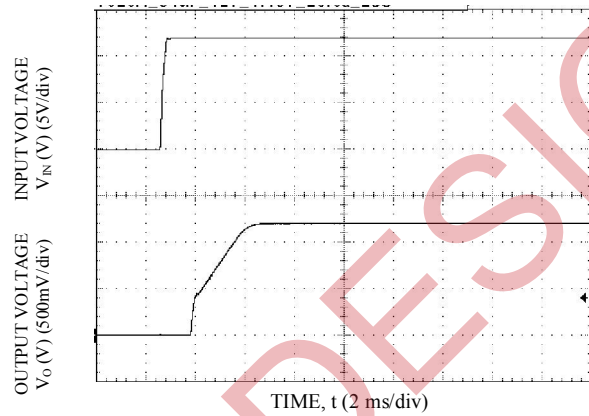

Start-up Using Input Voltage ($V_{IN} = 12V$, $I_o = I_{o,max}$), $V_o=1.2V$

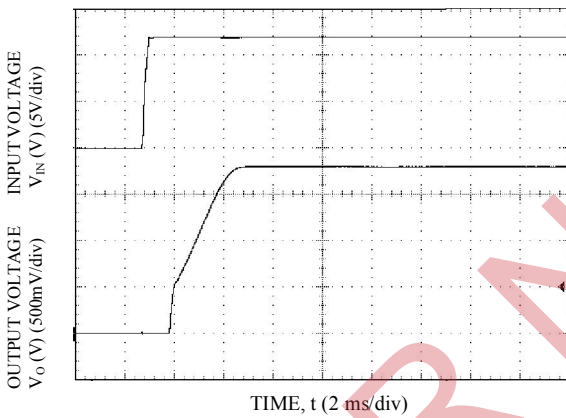

Start-up Using Input Voltage ($V_{IN} = 12V$, $I_o = I_{o,max}$), $V_o=1.8V$

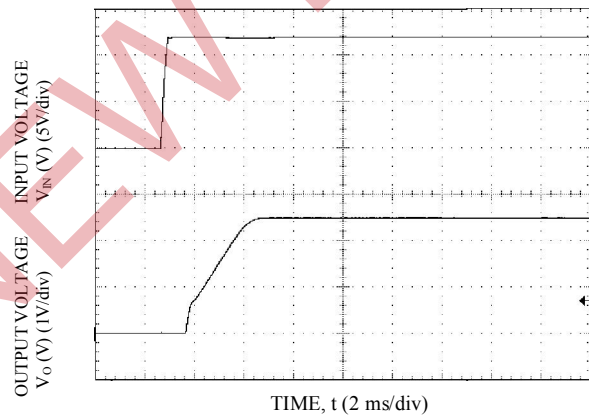

Start-up Using Input Voltage ($V_{IN} = 12V$, $I_o = I_{o,max}$), $V_o=2.5V$

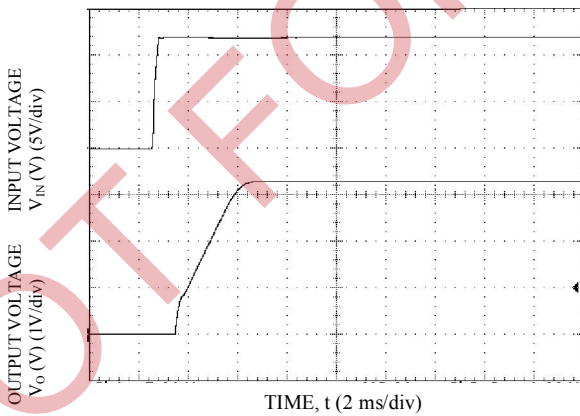

Start-up Using Input Voltage ($V_{IN} = 12V$, $I_o = I_{o,max}$), $V_o=3.3V$

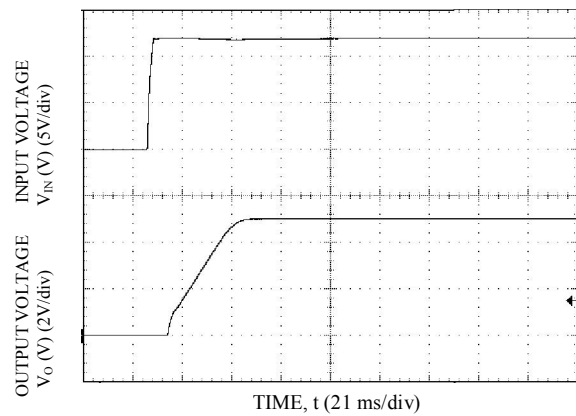

Start-up Using Input Voltage ($V_{IN} = 12V$, $I_o = I_{o,max}$), $V_o=5.0V$

NON-ISOLATED DC/DC CONVERTERS

3 Vdc – 14.4 Vdc Input, 0.6 Vdc - 5.5 Vdc /20 A Outputs



Jul. 14, 2015

Bel Power Inc., a subsidiary of Bel Fuse Inc.

Design Considerations

Input Filtering

The SLAN-20D1Ax module should be connected to a low ac-impedance source. A highly inductive source can affect the stability of the module. An input capacitance must be placed directly adjacent to the input pin of the module, to minimize input ripple voltage and ensure module stability .

To minimize input voltage ripple, ceramic capacitors are recommended at the input of the module. Figure 37 shows the input ripple voltage for various output voltages at 20A of load current with 2x22 μ F or 3x22 μ F ceramic capacitors and an input of 12V.

Figure 37

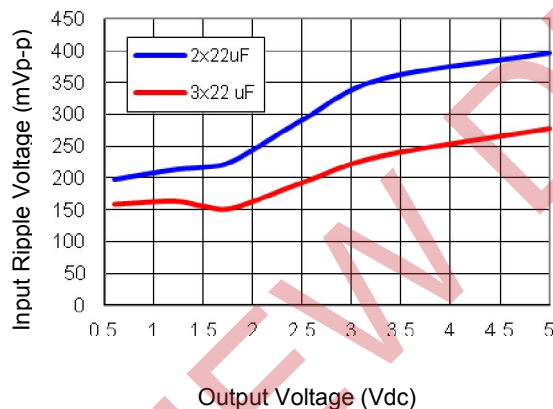

Note: Input ripple voltage for various output voltages with 2x22 μ F or 3x22 μ F ceramic capacitors at the input (20A load). Input voltage is 12V.

Output Filtering

These modules are designed for low output ripple voltage and will meet the maximum output ripple specification with 0.1 μ F ceramic and 2x47 μ F ceramic capacitors at the output of the module. However, additional output filtering may be required by the system designer for a number of reasons. First, there may be a need to further reduce the output ripple and noise of the module. Second, the dynamic response characteristics may need to be customized to a particular load step change.

To reduce the output ripple and improve the dynamic response to a step load change, additional capacitance at the output can be used. Low ESR polymer and ceramic capacitors are recommended to improve the dynamic response of the module. Figure 38 provides output ripple information for different external capacitance values at various V_o and a full load current of 20A. For stable operation of the module, limit the capacitance to less than the maximum output capacitance as specified in the electrical specification table. Optimal performance of the module can be achieved by using the Tunable Loop™ feature described later in this data sheet.

NON-ISOLATED DC/DC CONVERTERS

3 Vdc – 14.4 Vdc Input, 0.6 Vdc - 5.5 Vdc /20 A Outputs



Jul. 14, 2015

Bel Power Inc., a subsidiary of Bel Fuse Inc.

Output Filtering (continued)

Figure 38

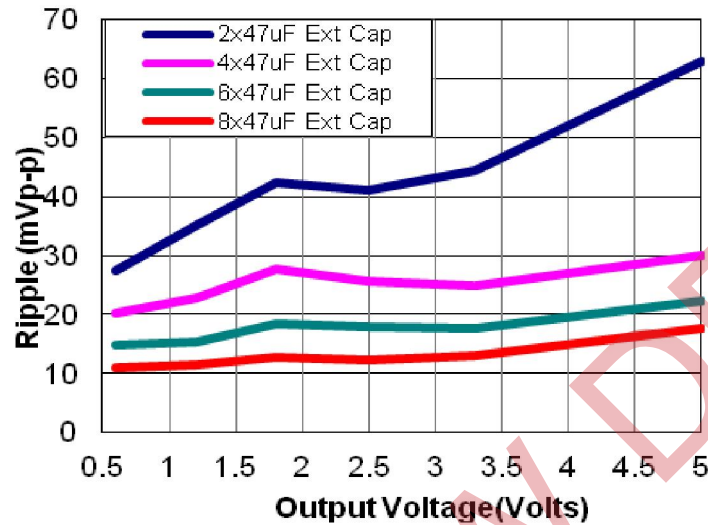

Note: Output ripple voltage for various output voltages with external 2x47 μ F, 4x47 μ F, 6x47 μ F or 8x47 μ F ceramic capacitors at the output (20A load). Input voltage is 12V.

Safety Considerations

For safety agency approval the power module must be installed in compliance with the spacing and separation requirements of the end-use safety agency standards, i.e., UL 60950-1 2nd, CSA C22.2 No. 60950-1-07, DIN EN 60950-1:2006 + A11 (VDE0805 Teil 1 + A11):2009-11; EN 60950-1:2006 + A11:2009-03.

For the converter output to be considered meeting the requirements of safety extra-low voltage (SELV), the input must meet SELV requirements. The power module has extra-low voltage (ELV) outputs when all inputs are ELV.

The SLAN-20D1Ax was tested using an external Littelfuse 456 series fast-acting fuse rated at 30 A, 100 Vdc in the ungrounded input.

NON-ISOLATED DC/DC CONVERTERS

3 Vdc – 14.4 Vdc Input, 0.6 Vdc - 5.5 Vdc /20 A Outputs



Jul. 14, 2015

Bel Power Inc., a subsidiary of Bel Fuse Inc.

Feature Descriptions

Remote On/Off

Parameter		Min	Typ	Max	Unit	Notes
Signal Low (Unit On)	Active Low	-0.2	-	0.6	V	The remote on/off pin open, Unit on.
Signal High (Unit Off)		2.0	-	$V_{in,max}$	V	
Signal Low (Unit Off)	Active High	-0.2	-	0.6	V	The remote on/off pin open, Unit on.
Signal High (Unit On)		2.0	-	$V_{in,max}$	V	

The SLAN-20D1Ax modules feature an On/Off pin for remote On/Off operation. Two On/Off logic options are available. In the Positive Logic On/Off option, (device code suffix "0" – see Ordering Information), the module turns ON during a logic High on the On/Off pin and turns OFF during a logic Low. With the Negative Logic On/Off option, (device code suffix "L" – see Ordering Information), the module turns OFF during logic High and ON during logic Low. The On/Off signal should be always referenced to ground. For either On/Off logic option, leaving the On/Off pin disconnected will turn the module ON when input voltage is present.

For positive logic modules, the circuit configuration for using the On/Off pin is shown in Figure 39. When the external transistor Q2 is in the OFF state, the internal transistor Q7 is turned OFF, which keeps Q6 OFF and Q5 OFF. This allows the internal PWM #Enable signal to be pulled up by the internal 3.3V, thus turning the module ON. When transistor Q2 is turned ON, the On/Off pin is pulled low, which turns Q7, Q6 and Q5 ON and the internal PWM #Enable signal is pulled low and the module is OFF. A suggested value for R_{pullup} is 20k Ω .

For negative logic On/Off modules, the circuit configuration is shown in Fig. 40. The On/Off pin should be pulled high with an external pull-up resistor (suggested value for the 3V to 14V input range is 20kOhms). When transistor Q2 is in the OFF state, the On/Off pin is pulled high, transistor Q3 is turned ON. This turns Q6 ON, followed by Q5 turning ON which pulls the internal ENABLE low and the module is OFF. To turn the module ON, Q2 is turned ON pulling the On/Off pin low, turning transistor Q3 OFF, which keeps Q6 and Q5 OFF resulting in the PWM Enable pin going high.

Figure 39

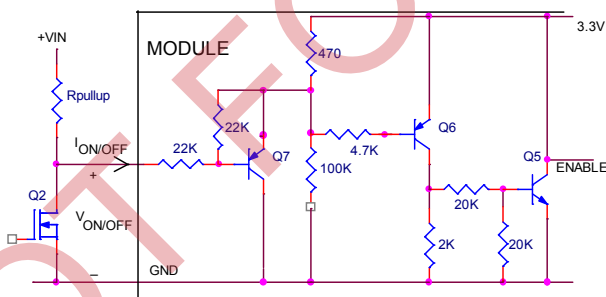

Circuit configuration for using positive On/Off logic.

Figure 40

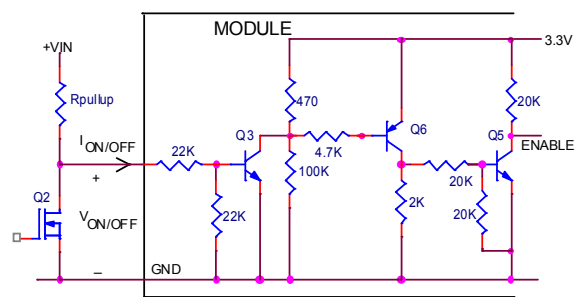

Circuit configuration for using negative On/Off logic

NON-ISOLATED DC/DC CONVERTERS

3 Vdc – 14.4 Vdc Input, 0.6 Vdc - 5.5 Vdc /20 A Outputs



Jul. 14, 2015

Bel Power Inc., a subsidiary of Bel Fuse Inc.

Monotonic Start-up and Shutdown

The module has monotonic start-up and shutdown behavior for any combination of rated input voltage, output current and operating temperature range.

Startup into Pre-biased Output

The module can start into a prebiased output as long as the prebias voltage is 0.5V less than the set output voltage.

Output Voltage Programming

The output voltage of the module is programmable to any voltage from 0.6Vdc to 5.5Vdc by connecting a resistor between the Trim and SIG_GND pins of the module. . Certain restrictions apply on the output voltage set point depending on the input voltage. These are shown in the Output Voltage vs. Input Voltage Set Point Area plot in Fig. 41. The Upper Limit curve shows that for output voltages lower than 1V, the input voltage must be lower than the maximum of 14.4V. The Lower Limit curve shows that for output voltages higher than 0.6V, the input voltage needs to be larger than the minimum of 3V.

Figure 41

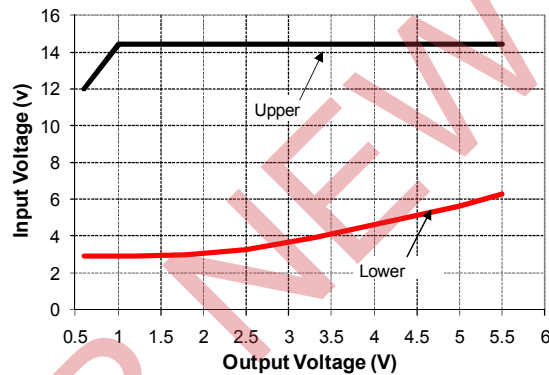

Note: Output Voltage vs. Input Voltage Set Point Area plot showing limits where the output voltage can be set for different input voltages.

Figure 42

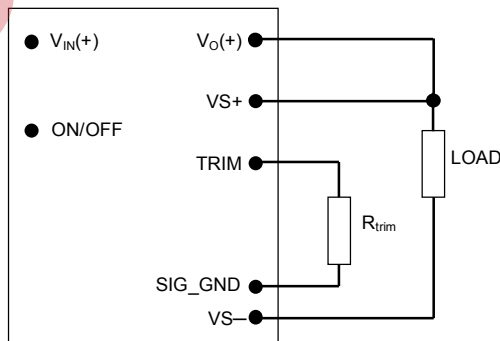

Caution – Do not connect SIG_GND to GND elsewhere in the layout
Circuit configuration for programming output voltage using an external resistor.

NON-ISOLATED DC/DC CONVERTERS

3 Vdc – 14.4 Vdc Input, 0.6 Vdc - 5.5 Vdc /20 A Outputs



Jul. 14, 2015

Bel Power Inc., a subsidiary of Bel Fuse Inc.

Output Voltage Programming(continued)

Without an external resistor between Trim and SIG_GND pins, the output of the module will be 0.6Vdc. To calculate the value of the trim resistor, R_{trim} for a desired output voltage, should be as per the following equation:

$$R_{trim} = \left[\frac{12}{(V_o - 0.6)} \right] k\Omega$$

R_{trim} is the external resistor in $k\Omega$

V_o is the desired output voltage.

Table 1 provides R_{trim} values required for some common output voltages.

Table1

$V_{o, set}$ (V)	R_{trim} (K Ω)
0.6	Open
0.9	40
1.0	30
1.2	20
1.5	13.33
1.8	10
2.5	6.316
3.3	4.444
5.0	2.727

Remote Sense

The power module has a Remote Sense feature to minimize the effects of distribution losses by regulating the voltage at the SENSE pin. The voltage between the SENSE pin and VOUT pin should not exceed 0.5V .

Voltage Margining

Output voltage margining can be implemented in the module by connecting a resistor, $R_{margin-up}$, from the Trim pin to the ground pin for margining-up the output voltage and by connecting a resistor, $R_{margin-down}$, from the Trim pin to output pin for margining-down. Figure 43 shows the circuit configuration for output voltage margining. Please consult your local Bel power technical representative for additional details.

Figure 43

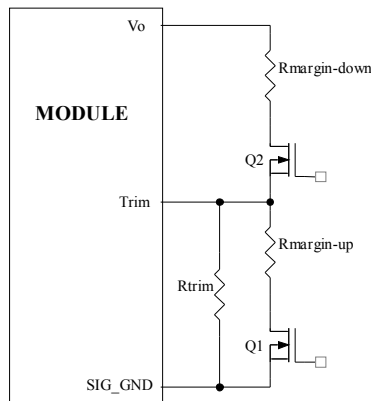

Circuit Configuration for margining Output voltage.

NON-ISOLATED DC/DC CONVERTERS

3 Vdc – 14.4 Vdc Input, 0.6 Vdc - 5.5 Vdc /20 A Outputs



Jul. 14, 2015

Bel Power Inc., a subsidiary of Bel Fuse Inc.

Output Voltage Sequencing

The power module includes a sequencing feature, EZ-SEQUENCE that enables users to implement various types of output voltage sequencing in their applications. This is accomplished via an additional sequencing pin. When not using the sequencing feature, leave it unconnected.

The voltage applied to the SEQ pin should be scaled down by the same ratio as used to scale the output voltage down to the reference voltage of the module. This is accomplished by an external resistive divider connected across the sequencing voltage before it is fed to the SEQ pin as shown in Fig. 44. In addition, a small capacitor (suggested value 100pF) should be connected across the lower resistor R1.

For all SLDN-20D1Ax modules, the minimum recommended delay between the ON/OFF signal and the sequencing signal is 10ms to ensure that the module output is ramped up according to the sequencing signal. This ensures that the module soft-start routine is completed before the sequencing signal is allowed to ramp up.

Figure 44

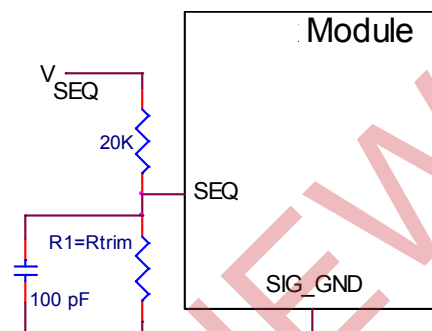

Circuit showing connection of the sequencing signal to the SEQ pin.

When the scaled down sequencing voltage is applied to the SEQ pin, the output voltage tracks this voltage until the output reaches the set-point voltage. The final value of the sequencing voltage must be set higher than the set-point voltage of the module. The output voltage follows the sequencing voltage on a one-to-one basis. By connecting multiple modules together, multiple modules can track their output voltages to the voltage applied on the SEQ pin.

To initiate simultaneous shutdown of the modules, the SEQ pin voltage is lowered in a controlled manner. The output voltage of the modules tracks the voltages below their set-point voltages on a one-to-one basis. A valid input voltage must be maintained until the tracking and output voltages reach ground potential.

Overcurrent Protection

To provide protection in a fault (output overload) condition, the unit is equipped with internal current-limiting circuitry and can endure current limiting continuously. At the point of current-limit inception, the unit enters hiccup mode. The unit operates normally once the output current is brought back into its specified range.

Overtemperature Protection

To provide protection in a fault condition, the unit is equipped with a thermal shutdown circuit. The unit will shut down if the overtemperature threshold of 120°C (typ) is exceeded at the thermal reference point T_{ref} . Once the unit goes into thermal shutdown it will then wait to cool before attempting to restart.

NON-ISOLATED DC/DC CONVERTERS

3 Vdc – 14.4 Vdc Input, 0.6 Vdc - 5.5 Vdc /20 A Outputs



Jul. 14, 2015

Bel Power Inc., a subsidiary of Bel Fuse Inc.

Input Undervoltage Lockout

At input voltages below the input undervoltage lockout limit, the module operation is disabled. The module will begin to operate at an input voltage above the undervoltage lockout turn-on threshold.

Synchronization

The module switching frequency can be synchronized to a signal with an external frequency within a specified range. Synchronization can be done by using the external signal applied to the SYNC pin of the module as shown in Fig. 45, with the converter being synchronized by the rising edge of the external signal. The Electrical Specifications table specifies the requirements of the external SYNC signal. If the SYNC pin is not used, the module should free run at the default switching frequency. **If synchronization is not being used, connect the SYNC pin to GND.**

Figure 45

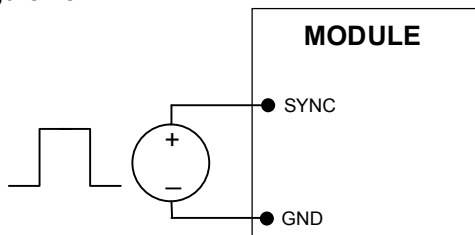

External source connections to synchronize switching frequency of the module.

Power Good

The module provides a Power Good (PGOOD) signal that is implemented with an open-drain output to indicate that the output voltage is within the regulation limits of the power module. The PGOOD signal will be de-asserted to a low state if any condition such as overtemperature, overcurrent or loss of regulation occurs that would result in the output voltage going $\pm 10\%$ outside the setpoint value. The PGOOD terminal can be connected through a pullup resistor (suggested value 100K Ω) to a source of 5VDC or lower.

Dual Layout

Identical dimensions and pin layout of Analog and Digital modules permit migration from one to the other without needing to change the layout. In both cases the trim resistor is connected between trim and signal ground.

Tunable Loop™

The module has a feature that optimizes transient response of the module called Tunable Loop™.

External capacitors are usually added to the output of the module for two reasons: to reduce output ripple and noise (see Figure 38) and to reduce output voltage deviations from the steady-state value in the presence of dynamic load current changes. Adding external capacitance however affects the voltage control loop of the module, typically causing the loop to slow down with sluggish response. Larger values of external capacitance could also cause the module to become unstable.

The Tunable Loop™ allows the user to externally adjust the voltage control loop to match the filter network connected to the output of the module. The Tunable Loop™ is implemented by connecting a series R-C between the SENSE and TRIM pins of the module, as shown in Fig. 46. This R-C allows the user to externally adjust the voltage loop feedback compensation of the module.

NON-ISOLATED DC/DC CONVERTERS

3 Vdc – 14.4 Vdc Input, 0.6 Vdc - 5.5 Vdc /20 A Outputs



Jul. 14, 2015

Tunable Loop™(continued)

Bel Power Inc., a subsidiary of Bel Fuse Inc.

Figure 46

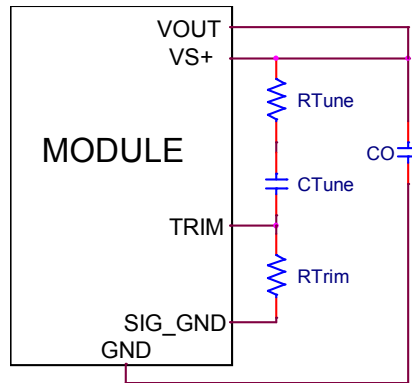

Circuit diagram showing connection of R_{TUNE} and C_{TUNE} to tune the control loop of the module.

Recommended values of R_{TUNE} and C_{TUNE} for different output capacitor combinations are given in Tables 2 and 3. Table 2 shows the recommended values of R_{TUNE} and C_{TUNE} for different values of ceramic output capacitors up to 1000uF that might be needed for an application to meet output ripple and noise requirements. Selecting R_{TUNE} and C_{TUNE} according to Table 2 will ensure stable operation of the module.

In applications with tight output voltage limits in the presence of dynamic current loading, additional output capacitance will be required. Table 3 lists recommended values of R_{TUNE} and C_{TUNE} in order to meet 2% output voltage deviation limits for some common output voltages in the presence of a 10A to 20A step change (50% of full load), with an input voltage of 12V.

Please contact your Bel Power technical representative to obtain more details of this feature as well as for guidelines on how to select the right value of external R-C to tune the module for best transient performance and stable operation for other output capacitance values or input voltages other than 12V.

Table 2

Co	2x47µF	4x47µF	6x47µF	10x47µF	20x47µF
R_{TUNE}	330	330	270	220	180
C_{TUNE}	47pF	560pF	1200pF	2200pF	4700pF

General recommended values of R_{TUNE} and C_{TUNE} for $V_{in}=12V$ and various external ceramic capacitor combinations.

Tunable Loop™(continued)

Table 3

V_o	5V	3.3V	2.5V	1.8V	1.2V	0.6V
C_o	8x47µF	5x47µF + 1x330µF Polymer	2x47µF + 2x330µF Polymer	2x47µF + 3x330µF Polymer	1x47µF + 5x330µF Polymer	1x47µF + 11x330µF Polymer
R_{TUNE}	220	220	220	220	180	180
C_{TUNE}	1500pF	2200pF	3300pF	5600pF	10nF	47nF
ΔV	100mV	64mV	49mV	36mV	24mV	12mV

Recommended values of R_{TUNE} and C_{TUNE} to obtain transient deviation of 2% of V_{out} for a 10A step load with $V_{in}=12V$.

NON-ISOLATED DC/DC CONVERTERS

3 Vdc – 14.4 Vdc Input, 0.6 Vdc - 5.5 Vdc /20 A Outputs



Jul. 14, 2015

Bel Power Inc., a subsidiary of Bel Fuse Inc.

Thermal Consideration

Power modules operate in a variety of thermal environments; however, sufficient cooling should always be provided to help ensure reliable operation.

Considerations include ambient temperature, airflow, module power dissipation, and the need for increased reliability. A reduction in the operating temperature of the module will result in an increase in reliability. The thermal data presented here is based on physical measurements taken in a wind tunnel. The test set-up is shown in Figure 47. The preferred airflow direction for the module is in Figure 48.

Figure 47

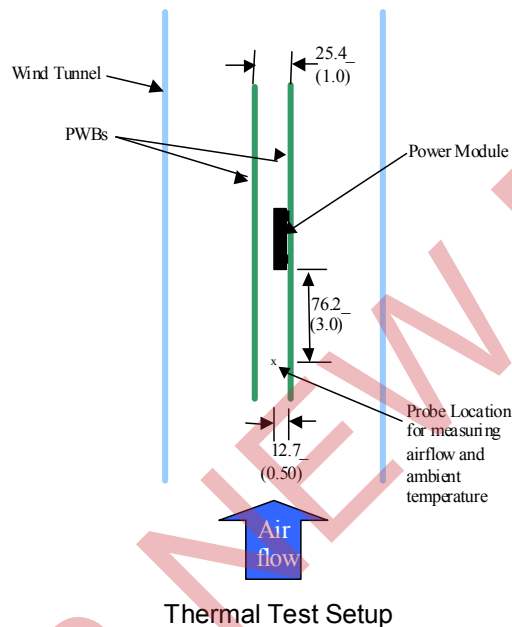

The thermal reference points, T_{ref} used in the specifications are also shown in Figure 48. For reliable operation the temperatures at these points should not exceed 120°C . The output power of the module should not exceed the rated power of the module ($V_{o,set} \times I_{o,max}$).

Please refer to the Application Note "Thermal Characterization Process For Open-Frame Board-Mounted Power Modules" for a detailed discussion of thermal aspects including maximum device temperatures.

Figure 48

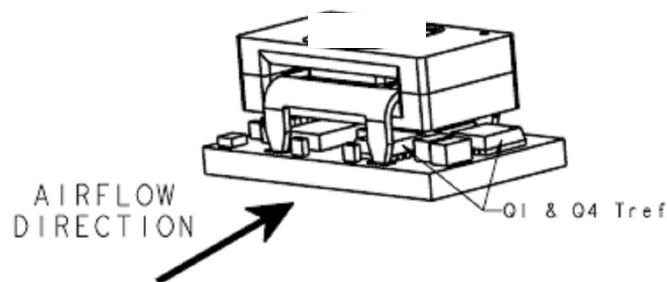

Preferred airflow direction and location of hot-spot of the module (T_{ref}).

NON-ISOLATED DC/DC CONVERTERS

3 Vdc – 14.4 Vdc Input, 0.6 Vdc - 5.5 Vdc /20 A Outputs



Jul. 14, 2015

Bel Power Inc., a subsidiary of Bel Fuse Inc.

Example Application Circuit

Requirements:

Vin:	12V
Vout:	1.8V
Iout:	15A max., worst case load transient is from 10A to 15A
ΔV_{out} :	1.5% of Vout (27mV) for worst case load transient
Vin, ripple	1.5% of Vin (180mV, p-p)

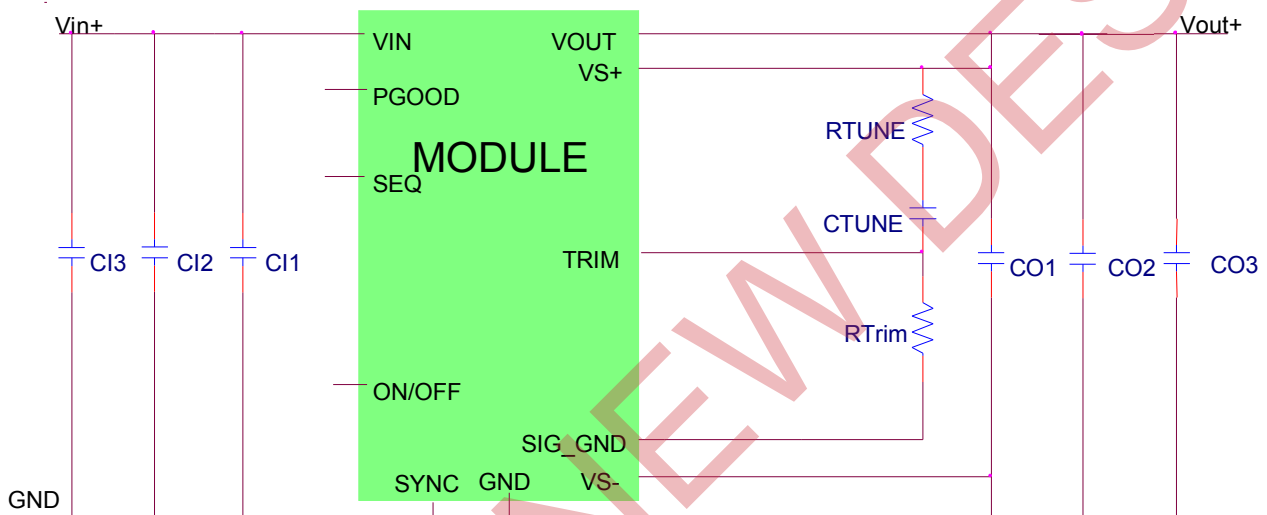

C11	Decoupling cap - 1x0.047 μ F/16V ceramic capacitor (e.g. Murata LLL185R71C473MA01)
C12	3x22 μ F/16V ceramic capacitor (e.g. Murata GRM32ER61C226KE20)
C13	47 μ F/16V bulk electrolytic
CO1	Decoupling cap - 1x0.047 μ F/16V ceramic capacitor (e.g. Murata LLL185R71C473MA01)
CO2	N.A.
CO3	3 x 330 μ F/6.3V Polymer (e.g. Sanyo Poscap)
CTune	4700pF ceramic capacitor (can be 1206, 0805 or 0603 size)
RTune	330 ohms SMT resistor (can be 1206, 0805 or 0603 size)
RTrim	10k Ω SMT resistor (can be 1206, 0805 or 0603 size, recommended tolerance of 0.1%)

NON-ISOLATED DC/DC CONVERTERS
 3 Vdc – 14.4 Vdc Input, 0.6 Vdc - 5.5 Vdc /20 A Outputs



Jul. 14, 2015

Bel Power Inc., a subsidiary of Bel Fuse Inc.

Mechanical Outline

Dimensions are in millimeters and (inches).

Tolerances: x.x mm ± 0.5 mm (x.xx in. ± 0.02 in.) [unless otherwise indicated]

x.xx mm ± 0.25 mm (x.xxx in ± 0.010 in.)

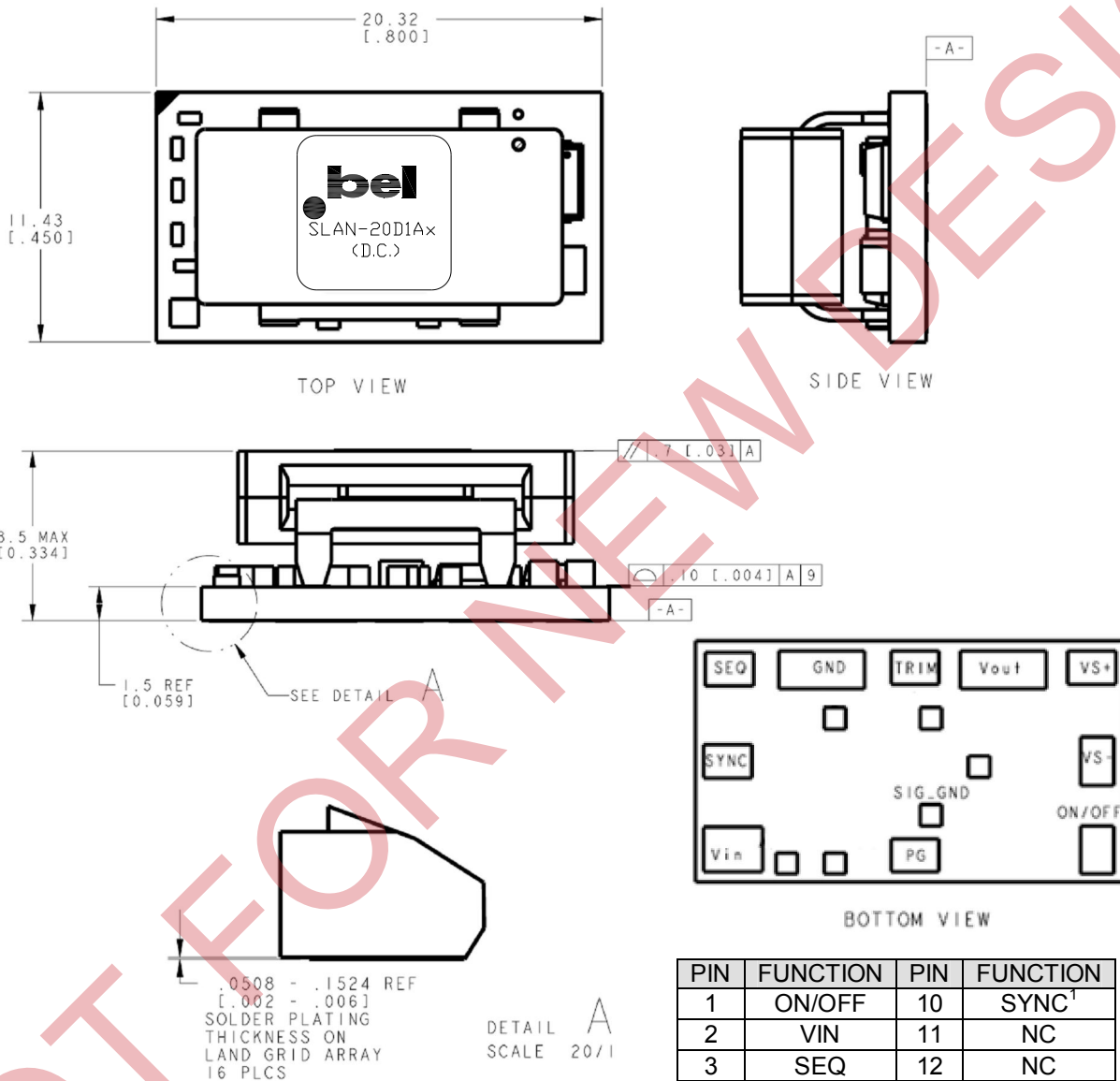

¹ If unused, connect to Ground.

NON-ISOLATED DC/DC CONVERTERS

3 Vdc – 14.4 Vdc Input, 0.6 Vdc - 5.5 Vdc /20 A Outputs



Jul. 14, 2015

Bel Power Inc., a subsidiary of Bel Fuse Inc.

Recommended Pad Layout

Dimensions are in millimeters and (inches).

Tolerances: x.x mm ± 0.5 mm (x.xx in. ± 0.02 in.) [unless otherwise indicated]

x.xx mm ± 0.25 mm (x.xxx in ± 0.010 in.)

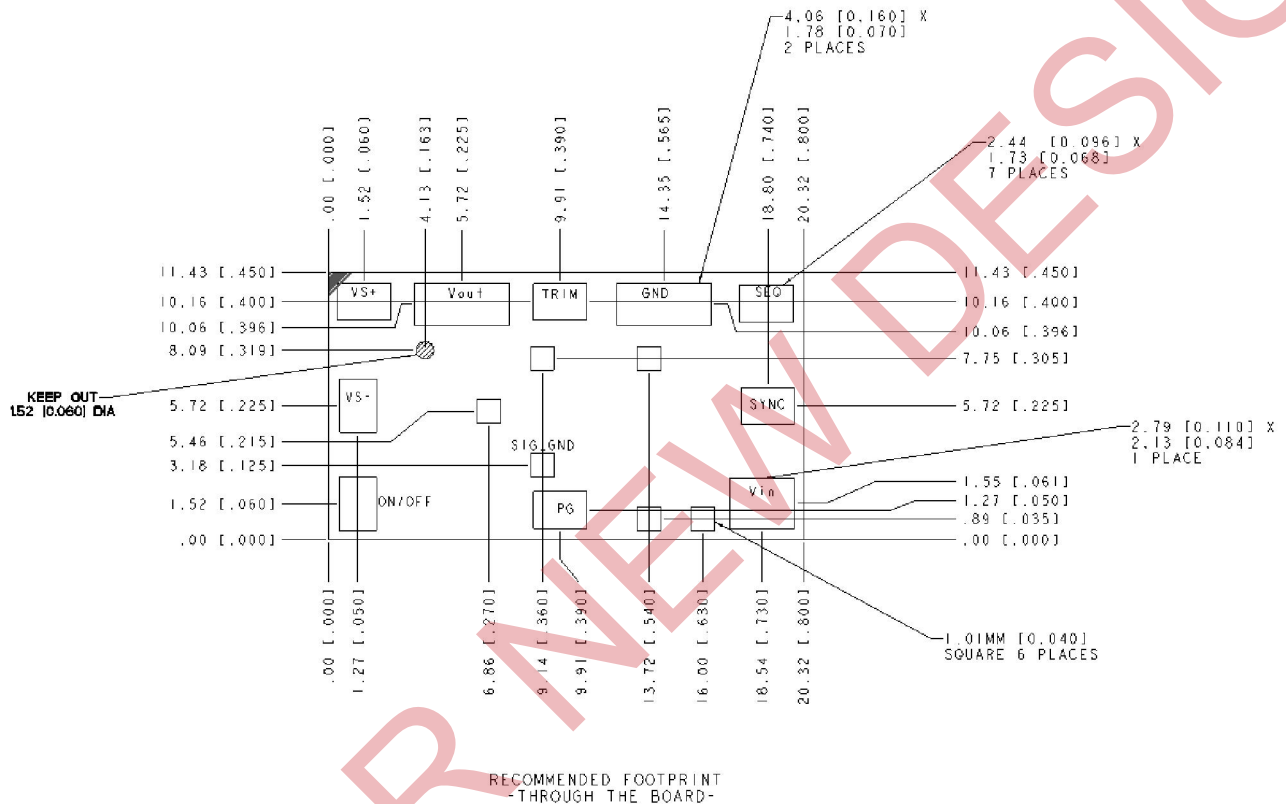

PIN	FUNCTION	PIN	FUNCTION
1	ON/OFF	10	SYNC ²
2	VIN	11	NC
3	SEQ	12	NC
4	GND	13	NC
5	TRIM	14	SIG_GND
6	VOUT	15	NC
7	VS+	16	NC
8	VS-		
9	PG		

² If unused, connect to Ground.

NON-ISOLATED DC/DC CONVERTERS

3 Vdc – 14.4 Vdc Input, 0.6 Vdc - 5.5 Vdc /20 A Outputs



Jul. 14, 2015

Bel Power Inc., a subsidiary of Bel Fuse Inc.

Packaging Details

The SLAN-20D1Ax modules are supplied in tape & reel as standard.
All Dimensions are in millimeters and (in inches)

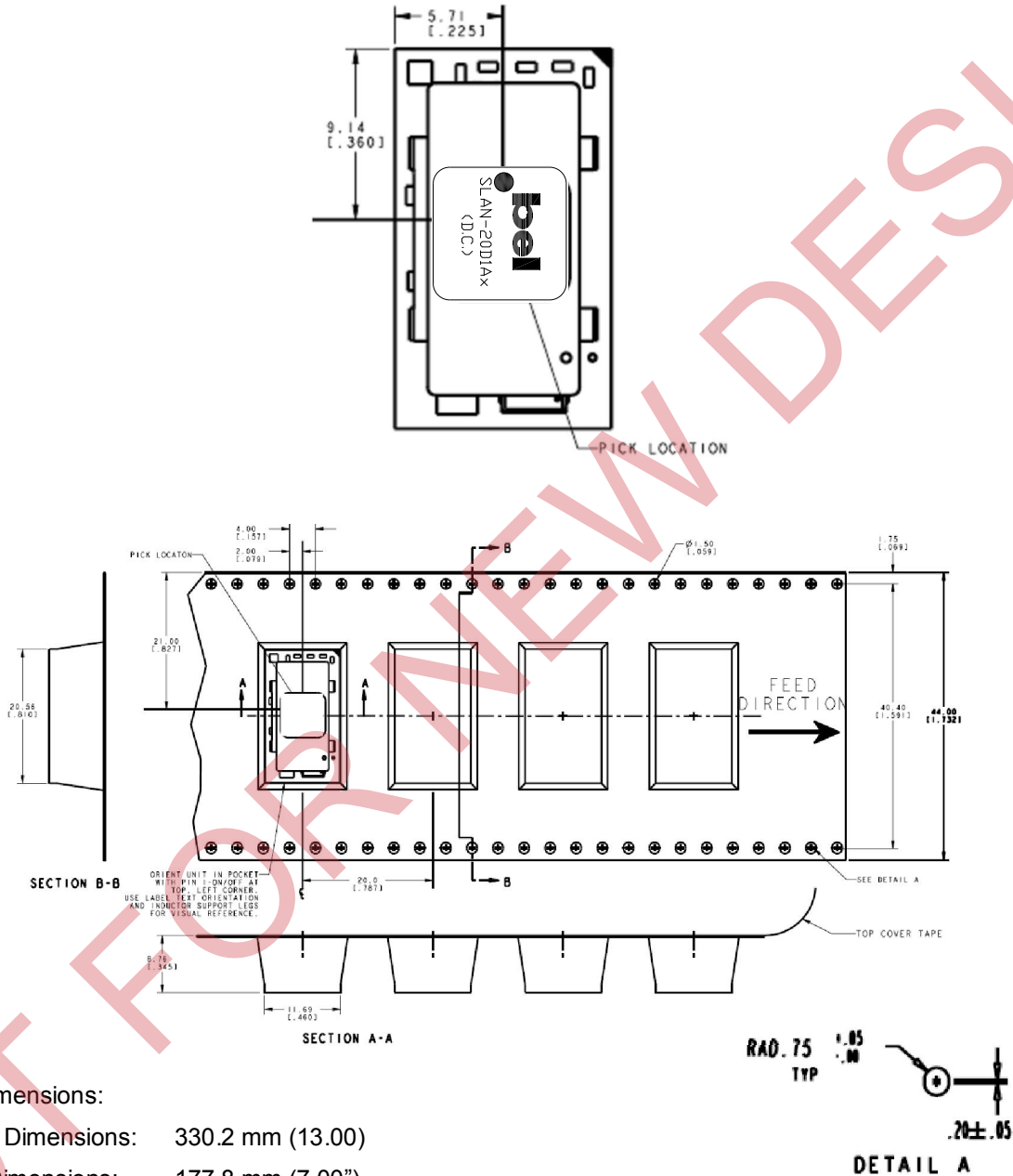

Reel Dimensions:

Outside Dimensions: 330.2 mm (13.00)

Inside Dimensions: 177.8 mm (7.00")

Tape Width: 44.00 mm (1.732")

NON-ISOLATED DC/DC CONVERTERS

3 Vdc – 14.4 Vdc Input, 0.6 Vdc - 5.5 Vdc /20 A Outputs



Jul. 14, 2015

Bel Power Inc., a subsidiary of Bel Fuse Inc.

Surface Mount Information

Pick and Place

The SLAN-20D1Ax modules use an open frame construction and are designed for a fully automated assembly process. The modules are fitted with a label designed to provide a large surface area for pick and place operations. The label meets all the requirements for surface mount processing, as well as safety standards, and is able to withstand reflow temperatures of up to 300°C. The label also carries product information such as product code, serial number and the location of manufacture.

Nozzle Recommendations

The module weight has been kept to a minimum by using open frame construction. Variables such as nozzle size, tip style, vacuum pressure and placement speed should be considered to optimize this process. The minimum recommended inside nozzle diameter for reliable operation is 3mm. The maximum nozzle outer diameter, which will safely fit within the allowable component spacing, is 7 mm.

Bottom Side / First Side Assembly

This module is not recommended for assembly on the bottom side of a customer board. If such an assembly is attempted, components may fall off the module during the second reflow process.

Lead Free Soldering

The modules are lead-free (Pb-free) and RoHS compliant and fully compatible in a Pb-free soldering process. Failure to observe the instructions below may result in the failure of or cause damage to the modules and can adversely affect long-term reliability.

Pb-free reflow profile

Power Systems will comply with J-STD-020 Rev. C (Moisture/Reflow Sensitivity Classification for Nonhermetic Solid State Surface Mount Devices) for both Pb-free solder profiles and MSL classification procedures. This standard provides a recommended forced-air-convection reflow profile based on the volume and thickness of the package (table 4-2). The suggested Pb-free solder paste is Sn/Ag/Cu (SAC). For questions regarding Land grid array(LGA) soldering, solder volume; please contact Bel power for special manufacturing process instructions. The recommended linear reflow profile using Sn/Ag/Cu solder is shown in Fig. 49. Soldering outside of the recommended profile requires testing to verify results and performance.

MSL Rating

The SLAN-20D1Ax modules have a MSL rating of 2A.

NON-ISOLATED DC/DC CONVERTERS

3 Vdc – 14.4 Vdc Input, 0.6 Vdc - 5.5 Vdc /20 A Outputs



Jul. 14, 2015

Bel Power Inc., a subsidiary of Bel Fuse Inc.

Storage and Handling

The recommended storage environment and handling procedures for moisture-sensitive surface mount packages is detailed in J-STD-033 Rev. A (Handling, Packing, Shipping and Use of Moisture/Reflow Sensitive Surface Mount Devices). Moisture barrier bags (MBB) with desiccant are required for MSL ratings of 2 or greater. These sealed packages should not be broken until time of use. Once the original package is broken, the floor life of the product at conditions of $\leq 30^{\circ}\text{C}$ and 60% relative humidity varies according to the MSL rating (see J-STD-033A). The shelf life for dry packed SMT packages will be a minimum of 12 months from the bag seal date, when stored at the following conditions: $< 40^{\circ}\text{C}$, $< 90\%$ relative humidity.

Figure49

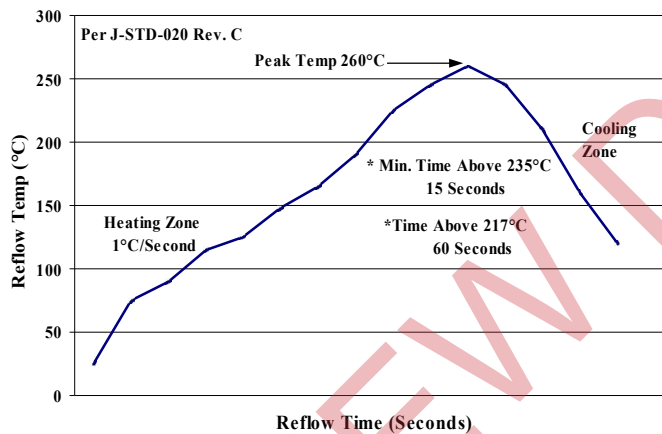

Recommended linear reflow profile using Sn/Ag/Cu solder.

Post Solder Cleaning and Drying Considerations

Post solder cleaning is usually the final circuit-board assembly process prior to electrical board testing. The result of inadequate cleaning and drying can affect both the reliability of a power module and the testability of the finished circuit-board assembly. For guidance on appropriate soldering, cleaning and drying procedures, refer to Board Mounted Power Modules: Soldering and Cleaning Application Note (AN04-001).

NON-ISOLATED DC/DC CONVERTERS
3 Vdc – 14.4 Vdc Input, 0.6Vdc - 5.5 Vdc /20 A Outputs



Jul. 14, 2015

Bel Power Inc., a subsidiary of Bel Fuse Inc.

Revision History

Date	Revision	Changes Detail	Approval
2012-03-20	A	First release	HL LU
2015-7-14	B	Update part selection, absolute maximum ratings, output specifications, general specifications, remote on/off, voltage margining, output voltage sequencing, example application circuit, Pb-free reflow profile, MSL rating and packaging details.	XF Jiang

RoHS Compliance

Complies with the European Directive 2011/65/EU, calling for the elimination of lead and other hazardous substances from electronic products.



©2015 Bel Fuse Inc. Specifications subject to change without notice. 071415

CORPORATE

Bel Fuse Inc.
206 Van Vorst Street
Jersey City, NJ 07302
Tel 201-432-0463
Fax 201-432-9542
www.belfuse.com

FAR EAST

Bel Fuse Ltd.
8F/ 8 Luk Hop Street
San Po Kong
Kowloon, Hong Kong
Tel 852-2328-5515
Fax 852-2352-3706
www.belfuse.com

EUROPE

Bel Fuse Europe Ltd.
Preston Technology Management Centre
Marsh Lane, Suite G7, Preston
Lancashire, PR1 8UD, U.K.
Tel 44-1772-556601
Fax 44-1772-888366
www.belfuse.com