

User's Guide

D0109MT-20-0901

VFD- RoHS Compliant

(Vacuum Fluorescent Display Module)

For product support, contact

Newhaven Display International
2511 Technology Drive, #101
Elgin, IL 60124

Tel: (847) 844-8795 Fax: (847) 844-8796

February 22, 2008

Vacuum Fluorescent Display Specification

PART NUMBER: D0109MT-20-0901

FEATURES: 8 Digits, 7-Segmented, Automotive - **Measurement**

APPLICATION: Character Display (*7-Segmented*)

RATINGS: Below

Outer Dimensions	Panel Length	P.L.	100.0	mm	
	Panel Height	P.H.	20.5	mm	
	Panel Thickness	P.T.	6.5	mm	
Leads	Lead Pitch	L.P.	2.54	mm	
	Lead Out	-	SIL		
Character Size	Character Height	C.H.	8.0	mm	
	Character Width	C.W.	4.0	mm	
Item	Symbol	Min.	Recommended	Max.	Unit
Filament Voltage	Ef	3.42	3.80	4.18	Vac
Peak Grid Voltage	ec	10.8	40.0	50.0	Vp-p
Peak Anode Voltage	eb	10.8	40.0	50.0	Vp-p
-	tp	-	-	-	-
Duty Cycle	Du	-	1/15	-	-
Pulse Width	tp	-	100	-	uS
Operating Temperature	Topr	-20	-	+70	C
Storage Temperature	Tstg	-55	-	+ 85	C
Color of Illumination	Green				

D0109MT-20-0901

**Electrical
Characteristics**

Item	Symbol	Test Condition	Min.	Typical	Max.	Unit
Filament Current	If -	Ef = 3.8 Vac eb = ec = 0	97.2 -	108.0 -	118.8 -	mAac -
Anode Current	ib / 1G ib / 2~9G - - -	Ef = 3.8 Vac eb = 40.0 Vp-p ec = 40.0 Vp-p Du = 1/15 tp = 100uS	- - - - -	9.0 8.0 - - -	18.0 16.0 - - -	mA _{p-p} mA _{p-p} mA _{p-p} mA _{p-p} mA _{p-p}
Grid Current	ic / 1~9C - - - -		- - - - -	10.0 - - - -	20.0 - - - -	mA _{p-p} mA _{p-p} mA _{p-p} mA _{p-p} mA _{p-p}
Luminance	L(G) -		500 (246)	1000 (292)	-	cd/m ² fL
Luminance Ratio	Lmin/Lmax		50	-	-	%
Grid Cut-off Voltage	Ecco	Ef = 3.8 Vac eb = 40.0 Vdc	-4.5	-	-	Vdc
Anode Cut-off Voltage	Ebco	Ef = 3.8 Vac ec = 40.0 Vp-p Du = 1/15 tp = 100uS	-4.5	-	-	Vdc

Drive Mode = Dynamic State

外形图 (OUTER DIMENSION) (UNIT IN mm)

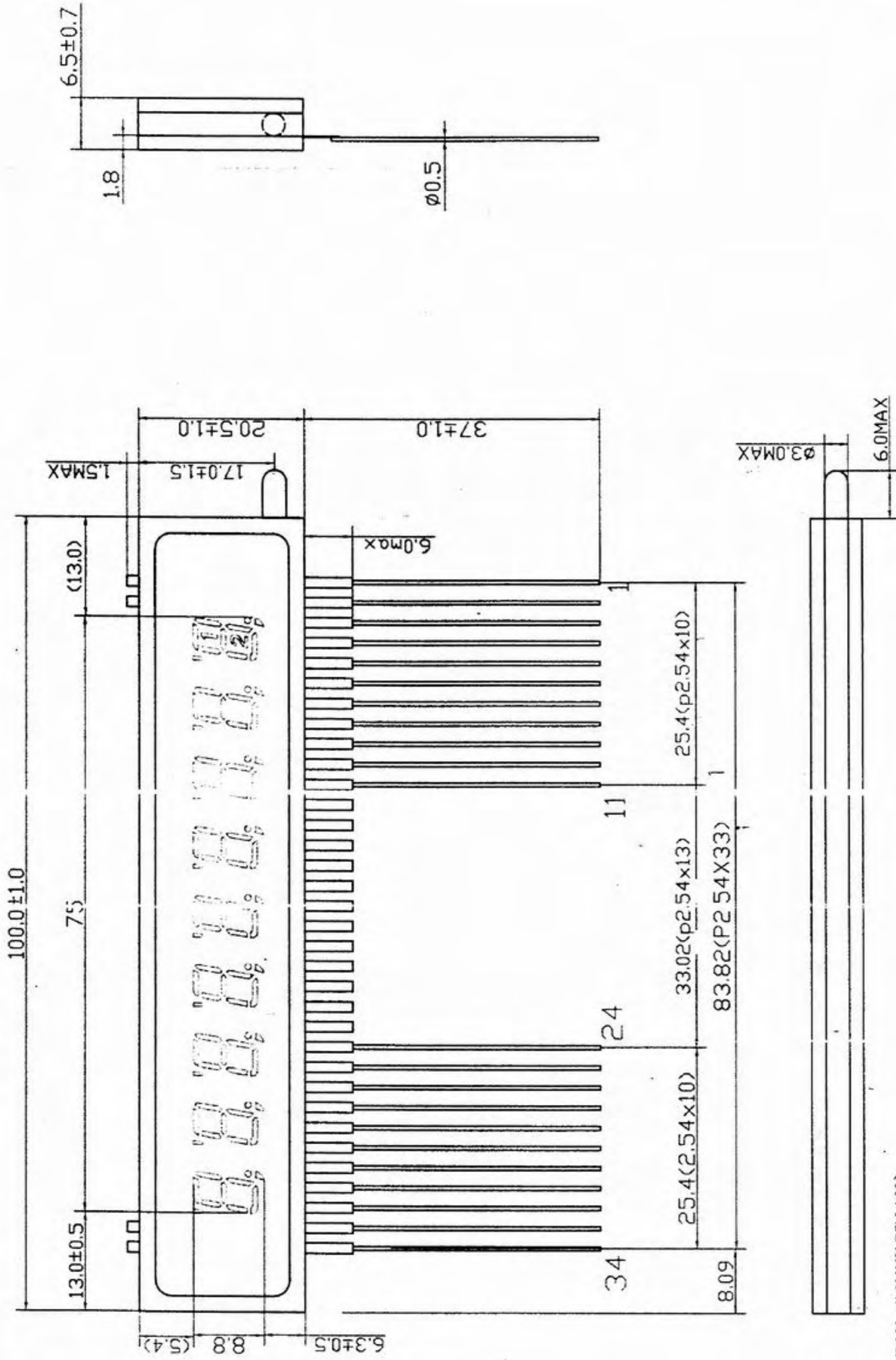

管脚连接 (PIN CONNECTION)

管脚序号 (PIN NO.)	1	2	3	4	5	6	7	8	9	10	11	12	13	14	15	16	17	18	19	20	21	22	23	24	25	26	27	28	29	30	31	32	33	34
连接 (CONNECTION)	F	a	b	12	c	dot	com	1G	2G	3G	4	NC	NC	NC	NC	NC	NC	NC	NC	NC	NC	NC	5G	6G	7G	8G	9G	d	e	9	f	AP	F	

栅极分割: (GRID ASSIGNMENT)

D0109MT-20-0901

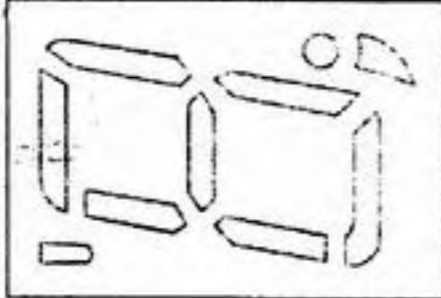
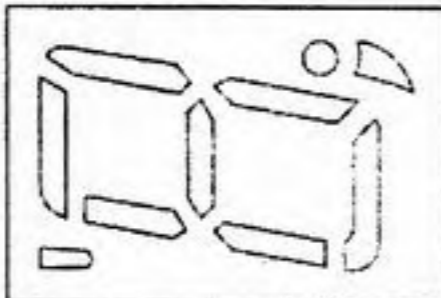
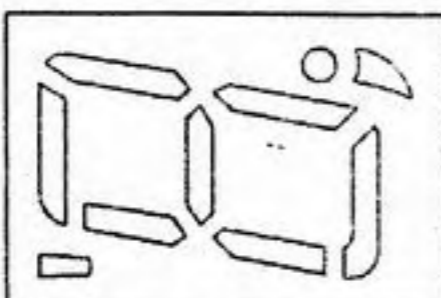
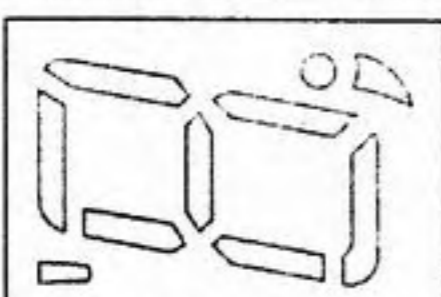
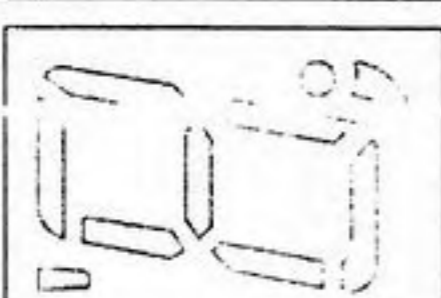
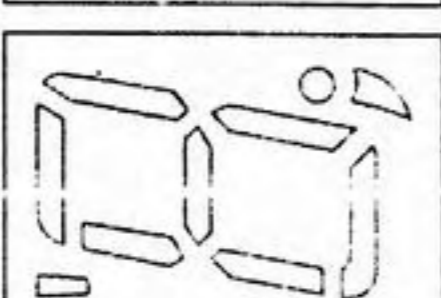
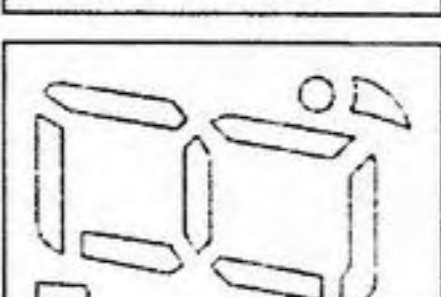
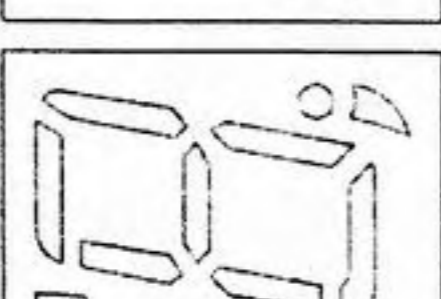
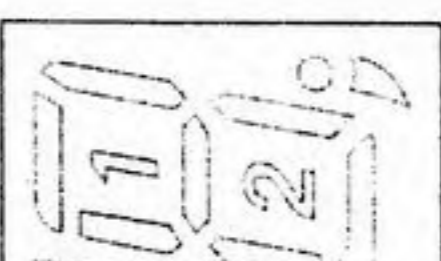
9G	8G	7G	6G	5G	4G	3G	2G	1G
								

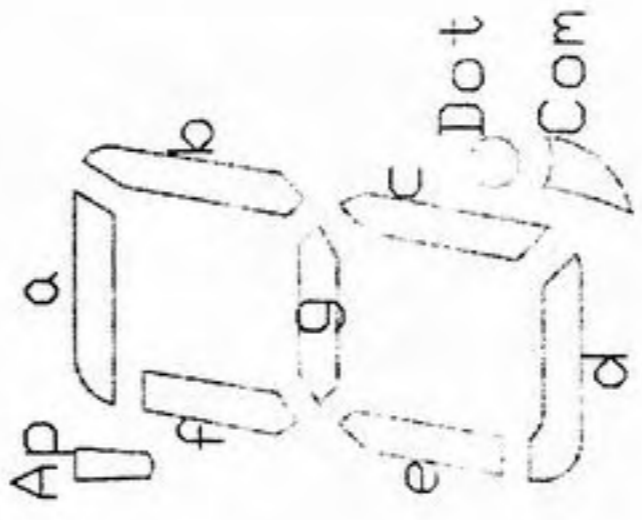
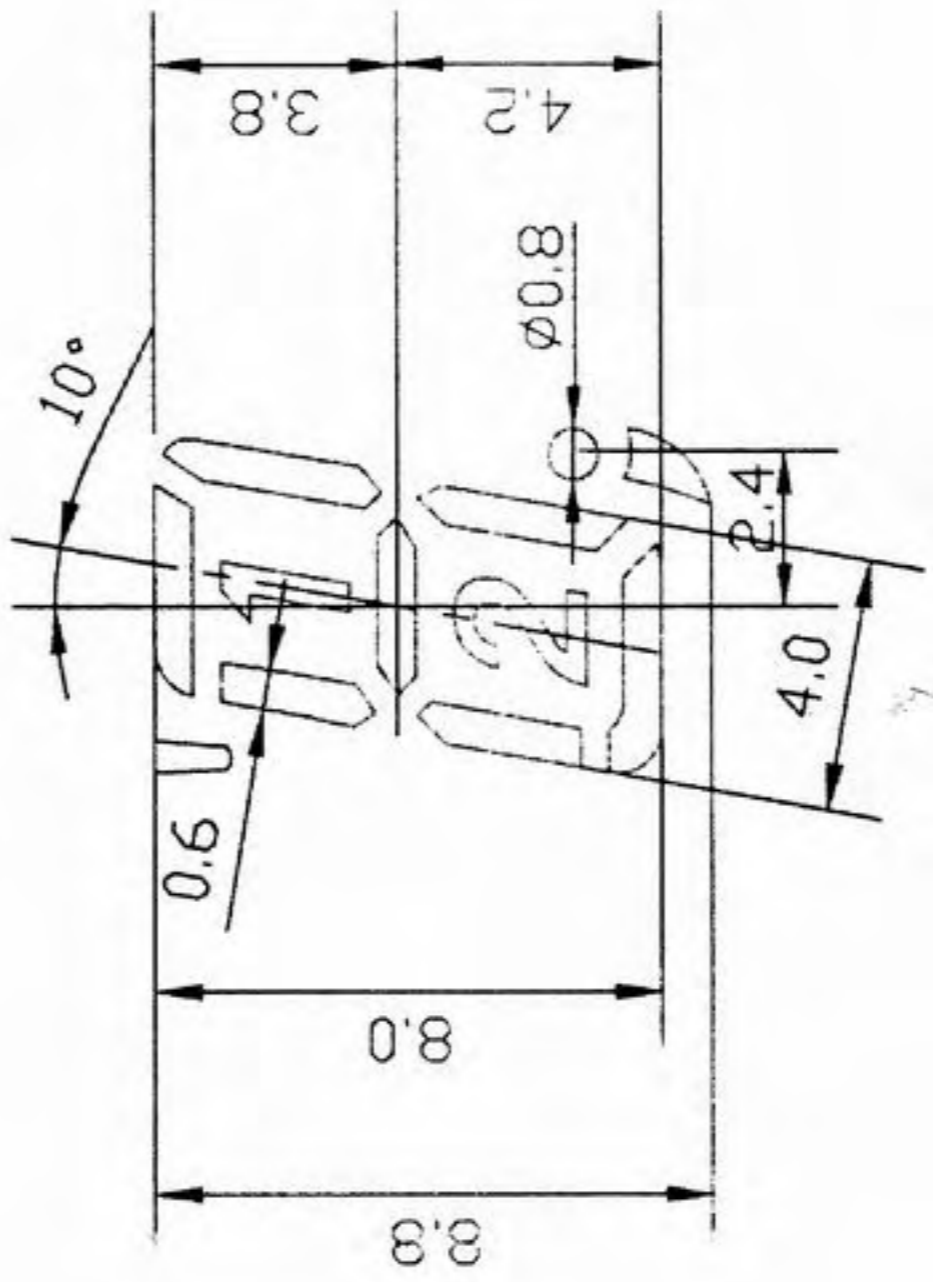

显示颜色(COLOR OF ILLUMINATION): 绿色

GREEN: X=0.250, Y=0.440

