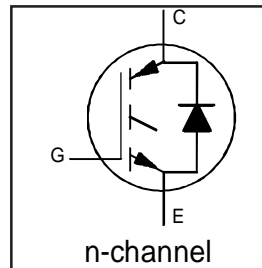


**Features**

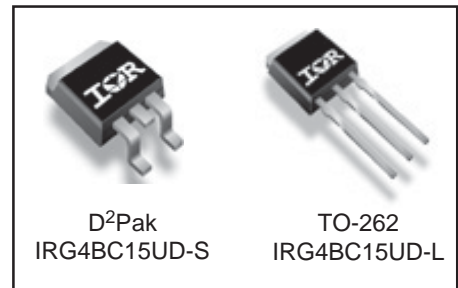
- UltraFast: Optimized for high frequencies from 10 to 30 kHz in hard switching
- IGBT Co-packaged with ultra-soft-recovery antiparallel diode
- Industry standard D<sup>2</sup>Pak & TO-262 packages
- Lead-Free

**Benefits**

- Best Value for Appliance and Industrial Applications
- High noise immune "Positive Only" gate drive- Negative bias gate drive not necessary
- For Low EMI designs- requires little or no snubbing
- Single Package switch for bridge circuit applications
- Compatible with high voltage Gate Driver IC's
- Allows simpler gate drive



$V_{CES} = 600V$
$V_{CE(on)} \text{ typ.} = 2.02V$
@ $V_{GE} = 15V, I_C = 7.8A$



**Absolute Maximum Ratings**

	Parameter	Max.	Units
$V_{CES}$	Collector-to-Emitter Voltage	600	V
$I_C @ T_C = 25^\circ C$	Continuous Collector Current	14	A
$I_C @ T_C = 100^\circ C$	Continuous Collector Current	7.8	
$I_{CM}$	Pulsed Collector Current ①	42	
$I_{LM}$	Clamped Inductive Load Current ②	42	
$I_F @ T_C = 100^\circ C$	Diode Continuous Forward Current	4.0	
$I_{FM}$	Diode Maximum Forward Current	16	
$V_{GE}$	Gate-to-Emitter Voltage	$\pm 20$	V
$P_D @ T_C = 25^\circ C$	Maximum Power Dissipation	49	W
$P_D @ T_C = 100^\circ C$	Maximum Power Dissipation	19	
$T_J$	Operating Junction and	-55 to +150	$^\circ C$
$T_{STG}$	Storage Temperature Range		
	Soldering Temperature, for 10 sec.	300 (0.063 in. (1.6mm) from case)	

**Thermal Resistance**

	Parameter	Min.	Typ.	Max.	Units
$R_{\theta JC}$	Junction-to-Case - IGBT	—	—	2.7	$^\circ C/W$
$R_{\theta JC}$	Junction-to-Case - Diode	—	—	7.0	
$R_{\theta CS}$	Case-to-Sink, flat, greased surface	—	0.50	—	
$R_{\theta JA}$	Junction-to-Ambient, typical socket mount ⑤	—	—	80	
$R_{\theta JA}$	Junction-to-Ambient (PCB Mount, steady state) ⑥	—	—	40	
Wt	Weight	—	2 (0.07)	—	g (oz)

# IRG4BC15UD-S/LPbF

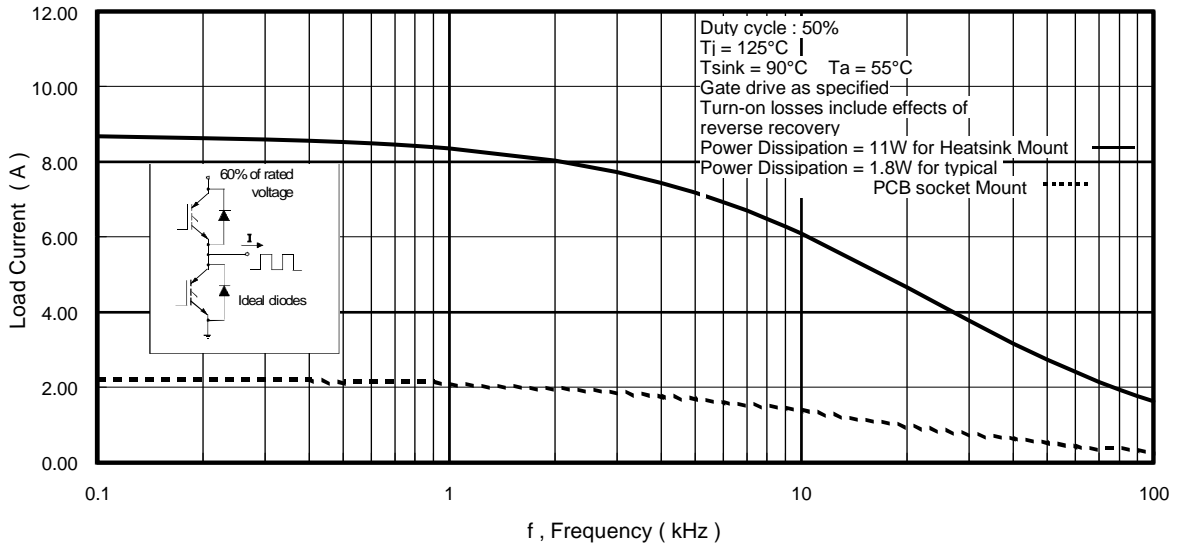
International  
**IR** Rectifier

## Electrical Characteristics @ T<sub>J</sub> = 25°C (unless otherwise specified)

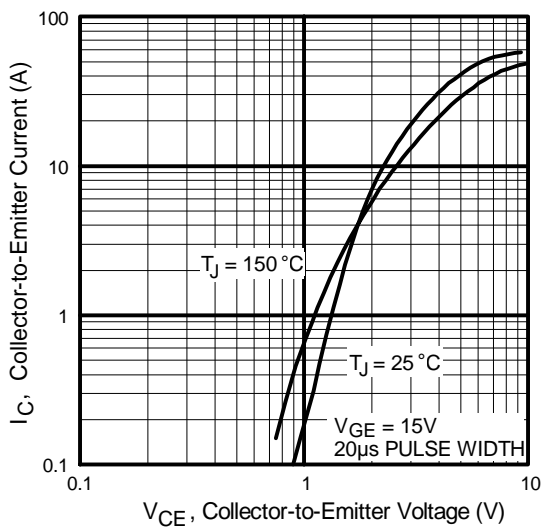
	Parameter	Min.	Typ.	Max.	Units	Conditions
V <sub>(BR)CES</sub>	Collector-to-Emitter Breakdown Voltage <sup>③</sup>	600	—	—	V	V <sub>GE</sub> = 0V, I <sub>C</sub> = 250μA
ΔV <sub>(BR)CES</sub> /ΔT <sub>J</sub>	Temperature Coeff. of Breakdown Voltage	—	0.63	—	V/°C	V <sub>GE</sub> = 0V, I <sub>C</sub> = 1.0mA
V <sub>CE(on)</sub>	Collector-to-Emitter Saturation Voltage	—	2.02	2.4	V	I <sub>C</sub> = 7.8A, V <sub>GE</sub> = 15V
		—	2.56	—		I <sub>C</sub> = 14A
		—	2.21	—		I <sub>C</sub> = 7.8A, T <sub>J</sub> = 150°C
V <sub>GE(th)</sub>	Gate Threshold Voltage	3.0	—	6.0		V <sub>CE</sub> = V <sub>GE</sub> , I <sub>C</sub> = 250μA
ΔV <sub>GE(th)</sub> /ΔT <sub>J</sub>	Temperature Coeff. of Threshold Voltage	—	-10	—	mV/°C	V <sub>CE</sub> = V <sub>GE</sub> , I <sub>C</sub> = 250μA
g <sub>fe</sub>	Forward Transconductance <sup>④</sup>	4.1	6.2	—	S	V <sub>CE</sub> = 100V, I <sub>C</sub> = 7.8A
I <sub>CES</sub>	Zero Gate Voltage Collector Current	—	—	250	μA	V <sub>GE</sub> = 0V, V <sub>CE</sub> = 600V
		—	—	1400		V <sub>GE</sub> = 0V, V <sub>CE</sub> = 600V, T <sub>J</sub> = 150°C
V <sub>FM</sub>	Diode Forward Voltage Drop	—	1.5	1.8	V	I <sub>C</sub> = 4.0A
		—	1.4	1.7		I <sub>C</sub> = 4.0A, T <sub>J</sub> = 150°C
I <sub>GES</sub>	Gate-to-Emitter Leakage Current	—	—	±100	nA	V <sub>GE</sub> = ±20V

## Switching Characteristics @ T<sub>J</sub> = 25°C (unless otherwise specified)

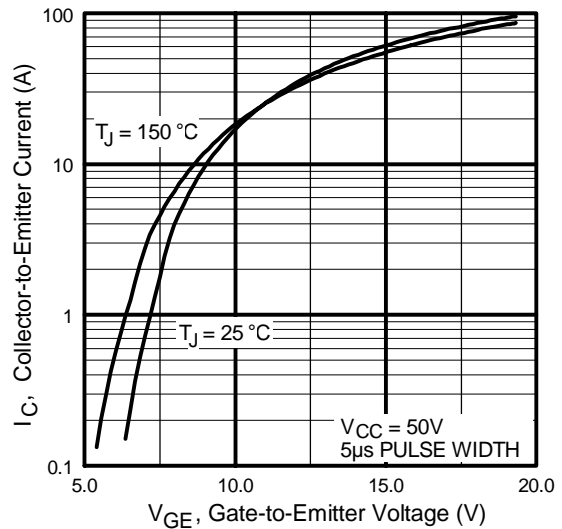
	Parameter	Min.	Typ.	Max.	Units	Conditions	
Q <sub>g</sub>	Total Gate Charge (turn-on)	—	23	35	nC	I <sub>C</sub> = 7.8A	
Q <sub>ge</sub>	Gate - Emitter Charge (turn-on)	—	4.0	6.0		V <sub>CC</sub> = 400V	
Q <sub>gc</sub>	Gate - Collector Charge (turn-on)	—	9.6	14		V <sub>GE</sub> = 15V	
t <sub>d(on)</sub>	Turn-On Delay Time	—	17	—	ns	T <sub>J</sub> = 25°C	
t <sub>r</sub>	Rise Time	—	20	—		I <sub>C</sub> = 7.8A, V <sub>CC</sub> = 480V	
t <sub>d(off)</sub>	Turn-Off Delay Time	—	160	240		V <sub>GE</sub> = 15V, R <sub>G</sub> = 75Ω	
t <sub>f</sub>	Fall Time	—	83	120		Energy losses include "tail" and diode reverse recovery.	
E <sub>on</sub>	Turn-On Switching Loss	—	0.24	—	mJ	T <sub>J</sub> = 150°C, I <sub>C</sub> = 7.8A, V <sub>CC</sub> = 480V V <sub>GE</sub> = 15V, R <sub>G</sub> = 75Ω Energy losses include "tail" and diode reverse recovery.	
E <sub>off</sub>	Turn-Off Switching Loss	—	0.26	—			
E <sub>ts</sub>	Total Switching Loss	—	0.50	0.63			
t <sub>d(on)</sub>	Turn-On Delay Time	—	16	—	ns	T <sub>J</sub> = 150°C, I <sub>C</sub> = 7.8A, V <sub>CC</sub> = 480V V <sub>GE</sub> = 15V, R <sub>G</sub> = 75Ω Energy losses include "tail" and diode reverse recovery.	
t <sub>r</sub>	Rise Time	—	21	—			
t <sub>d(off)</sub>	Turn-Off Delay Time	—	180	—			
t <sub>f</sub>	Fall Time	—	220	—			
E <sub>ts</sub>	Total Switching Loss	—	0.76	—	mJ		
L <sub>E</sub>	Internal Emitter Inductance	—	7.5	—	nH	Measured 5mm from package	
C <sub>ies</sub>	Input Capacitance	—	410	—	pF	V <sub>GE</sub> = 0V V <sub>CC</sub> = 30V f = 1.0MHz	
C <sub>oes</sub>	Output Capacitance	—	37	—			
C <sub>res</sub>	Reverse Transfer Capacitance	—	5.3	—			
t <sub>rr</sub>	Diode Reverse Recovery Time	—	28	42	ns	T <sub>J</sub> = 25°C	I <sub>F</sub> = 4.0A  V <sub>R</sub> = 200V  di/dt 200A/μs
		—	38	57		T <sub>J</sub> = 125°C	
I <sub>rr</sub>	Diode Peak Reverse Recovery Current	—	2.9	5.2	A	T <sub>J</sub> = 25°C	
		—	3.7	6.7		T <sub>J</sub> = 125°C	
Q <sub>rr</sub>	Diode Reverse Recovery Charge	—	40	60	nC	T <sub>J</sub> = 25°C	
		—	70	110		T <sub>J</sub> = 125°C	
di <sub>(rec)</sub> M/dt	Diode Peak Rate of Fall of Recovery During t <sub>b</sub>	—	280	—	A/μs	T <sub>J</sub> = 25°C	
		—	240	—		T <sub>J</sub> = 125°C	



**Fig. 1 - Typical Load Current vs. Frequency**  
 (Load Current =  $I_{\text{RMS}}$  of fundamental)



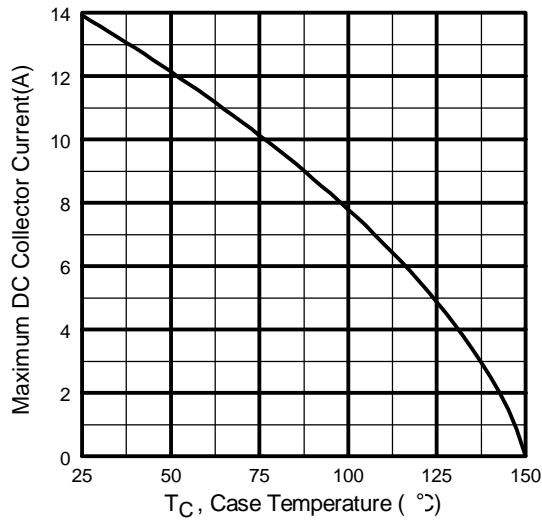
**Fig. 2 - Typical Output Characteristics**



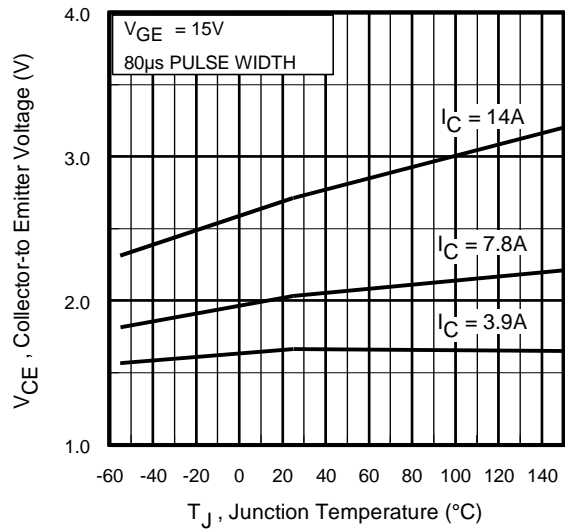
**Fig. 3 - Typical Transfer Characteristics**

# IRG4BC15UD-S/LPbF

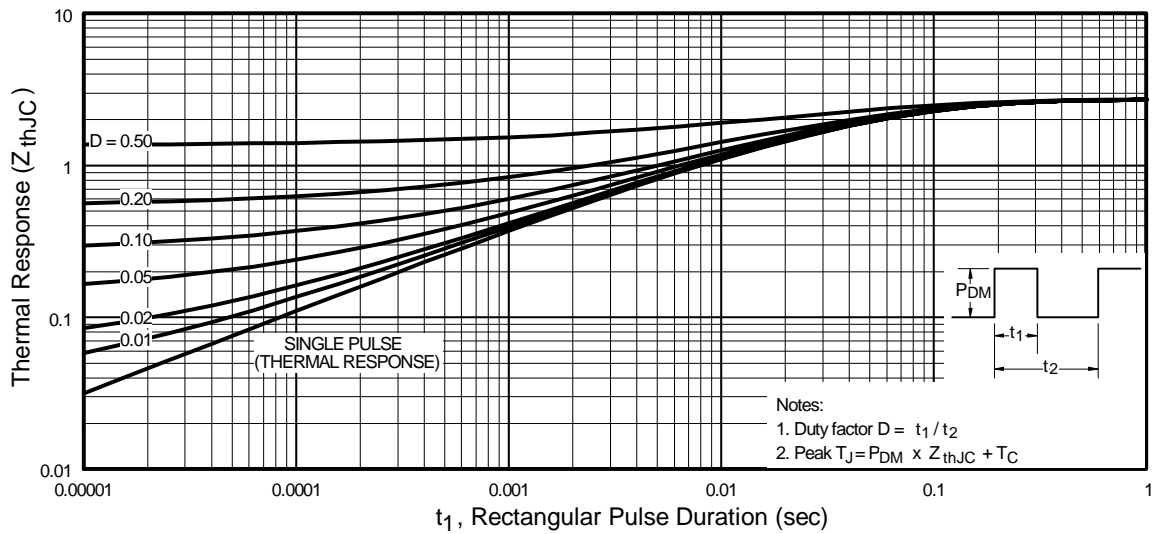
International  
**IR** Rectifier



**Fig. 4** - Maximum Collector Current vs. Case Temperature

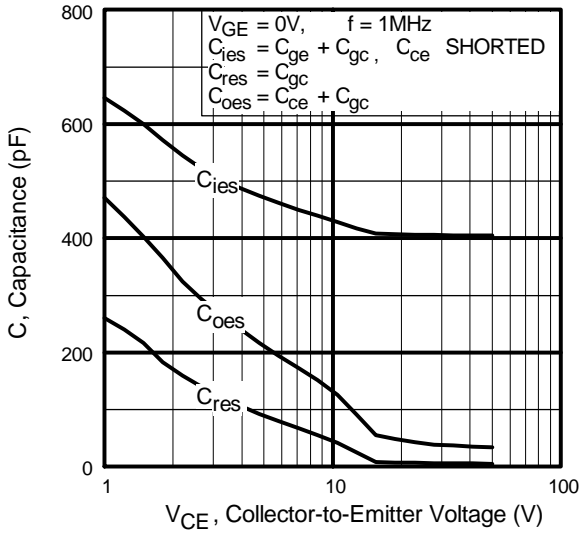


**Fig. 5** - Typical Collector-to-Emitter Voltage vs. Junction Temperature

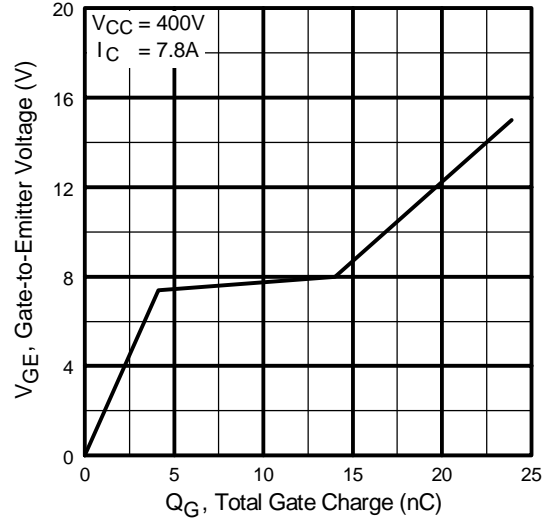


**Fig. 6** - Maximum Effective Transient Thermal Impedance, Junction-to-Case

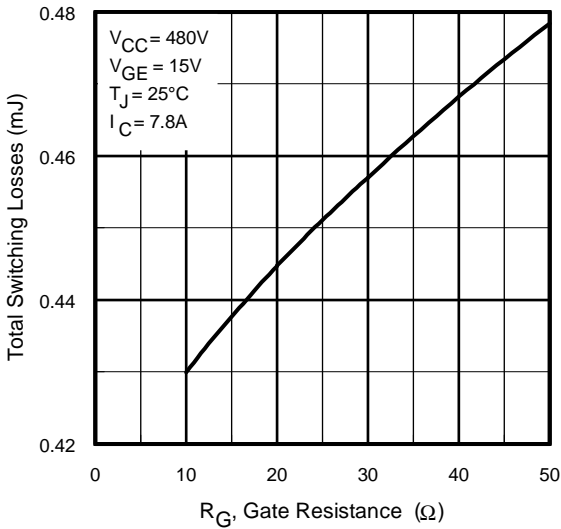
# IRG4BC15UD-S/LPbF



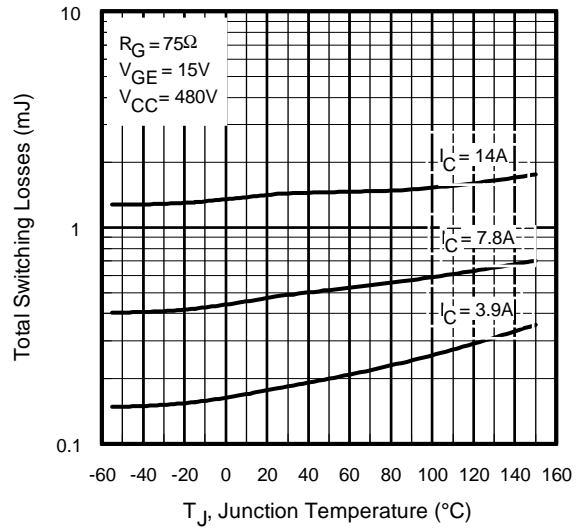
**Fig. 7** - Typical Capacitance vs. Collector-to-Emitter Voltage



**Fig. 8** - Typical Gate Charge vs. Gate-to-Emitter Voltage



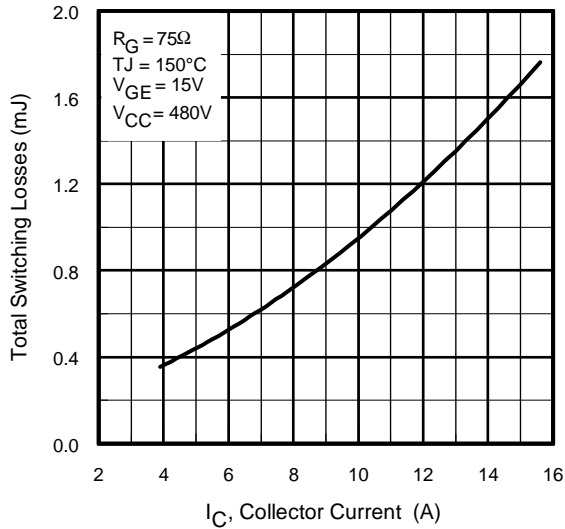
**Fig. 9** - Typical Switching Losses vs. Gate Resistance



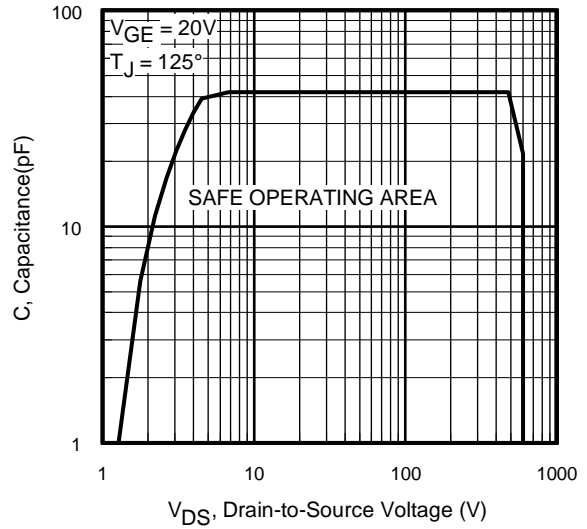
**Fig. 10** - Typical Switching Losses vs. Junction Temperature

# IRG4BC15UD-S/LPbF

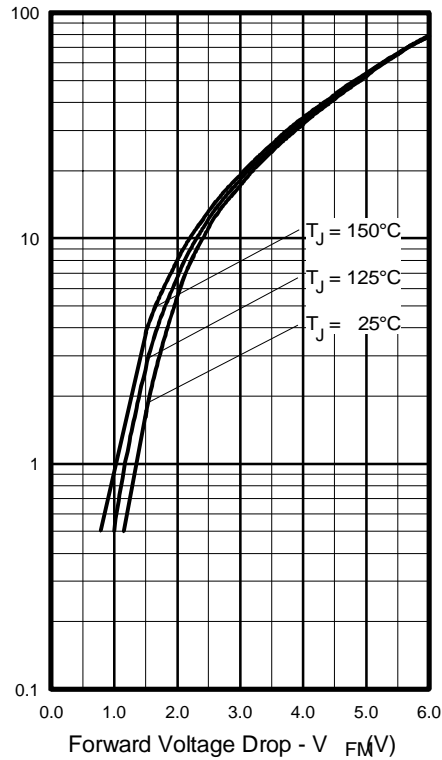
International  
**IR** Rectifier



**Fig. 11** - Typical Switching Losses vs. Collector-to-Emitter Current



**Fig. 12** - Turn-Off SOA



**Fig. 13** - Maximum Forward Voltage Drop vs. Instantaneous Forward Current

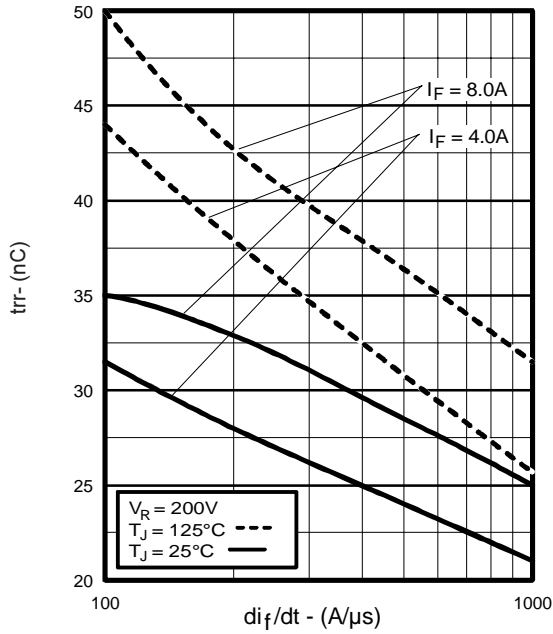


Fig. 14 - Typical Reverse Recovery vs.  $di_f/dt$

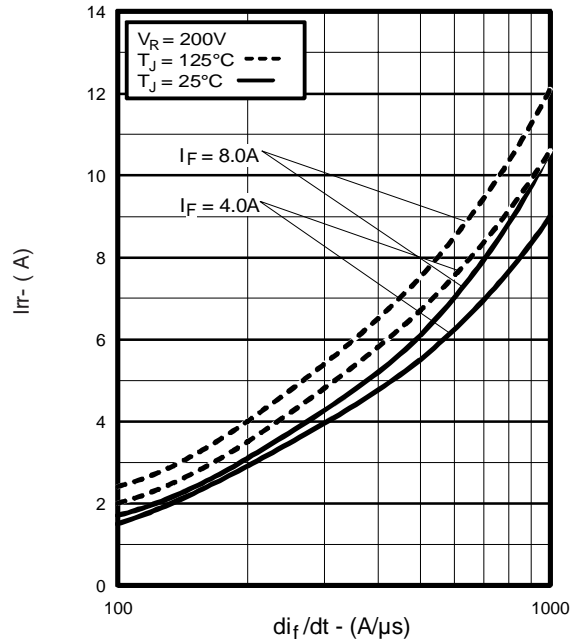


Fig. 15 - Typical Recovery Current vs.  $di_f/dt$

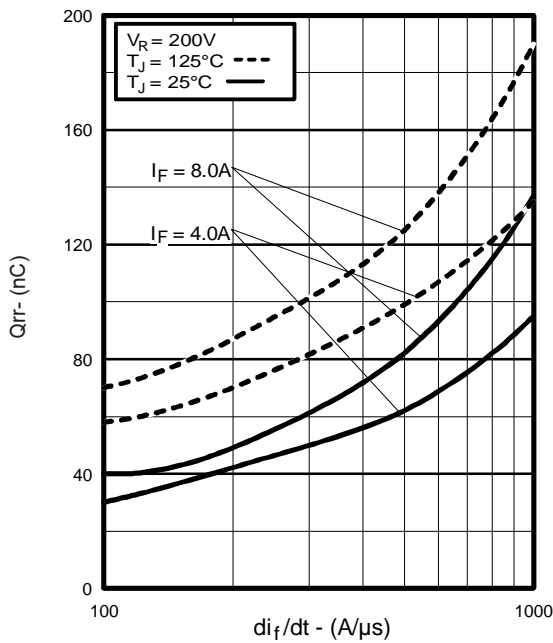


Fig. 16 - Typical Stored Charge vs.  $di_f/dt$

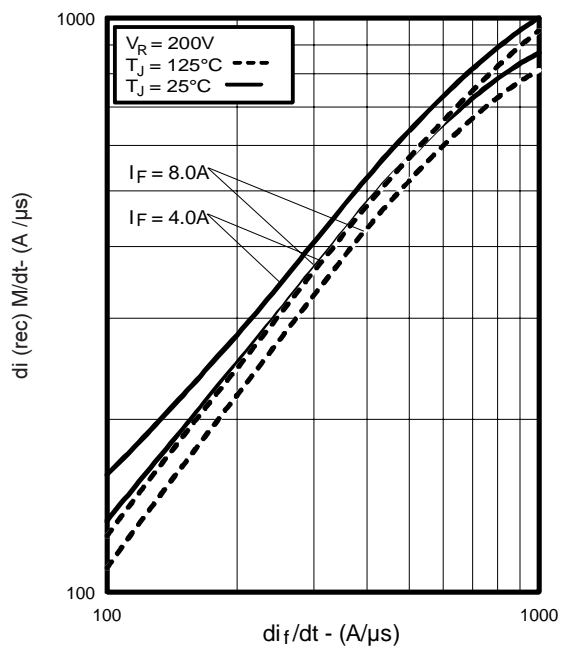
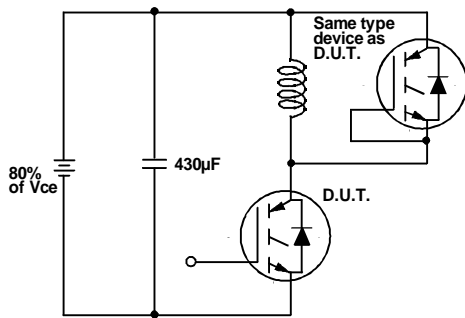


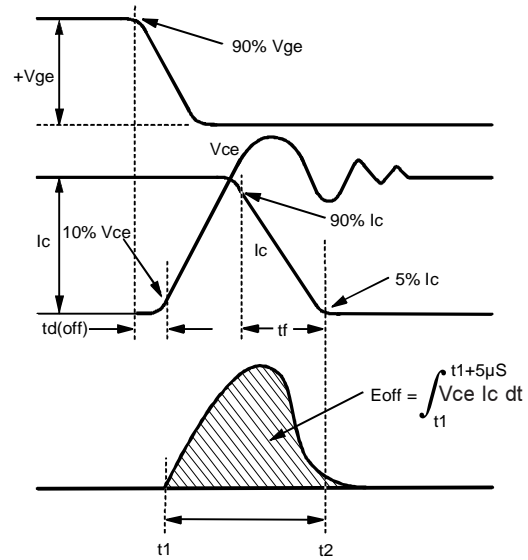
Fig. 17 - Typical  $di_{(rec)M}/dt$  vs.  $di_f/dt$ ,

# IRG4BC15UD-S/LPbF

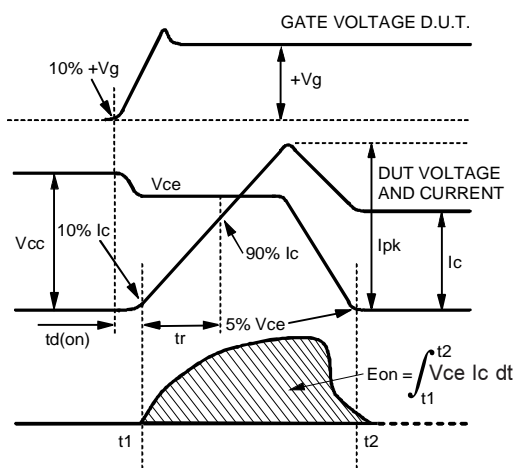
International  
**IR** Rectifier



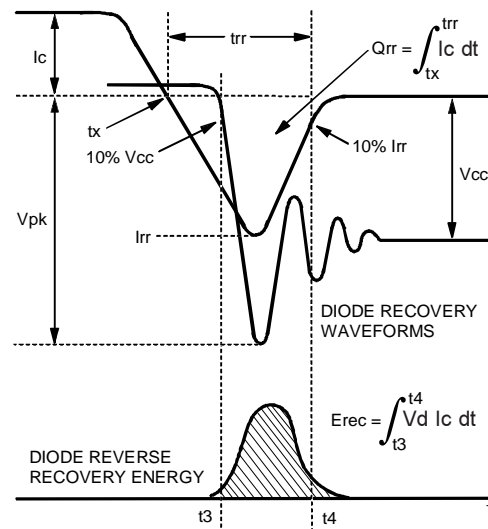
**Fig. 18a** - Test Circuit for Measurement of  $I_{LM}$ ,  $E_{on}$ ,  $E_{off}(\text{diode})$ ,  $t_{rr}$ ,  $Q_{rr}$ ,  $I_{rr}$ ,  $t_{d(on)}$ ,  $t_r$ ,  $t_{d(off)}$ ,  $t_f$



**Fig. 18b** - Test Waveforms for Circuit of Fig. 18a, Defining  $E_{off}$ ,  $t_{d(off)}$ ,  $t_f$



**Fig. 18c** - Test Waveforms for Circuit of Fig. 18a, Defining  $E_{on}$ ,  $t_{d(on)}$ ,  $t_r$



**Fig. 18d** - Test Waveforms for Circuit of Fig. 18a, Defining  $E_{rec}$ ,  $t_{tr}$ ,  $Q_{rr}$ ,  $I_{rr}$



# IRG4BC15UD-S/LPbF

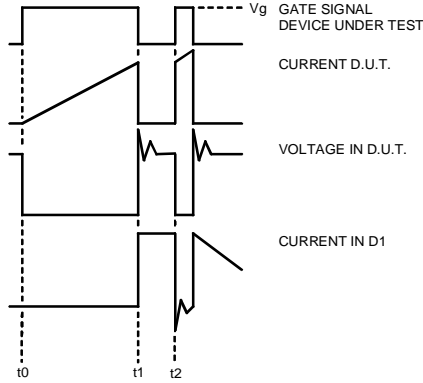


Figure 18e. Macro Waveforms for Figure 18a's Test Circuit

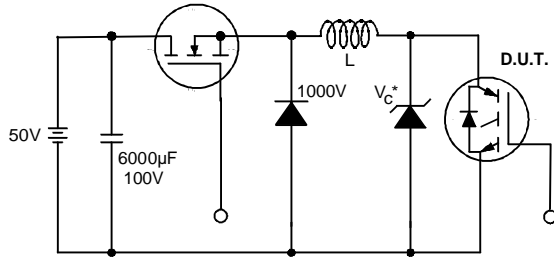


Figure 19. Clamped Inductive Load Test Circuit

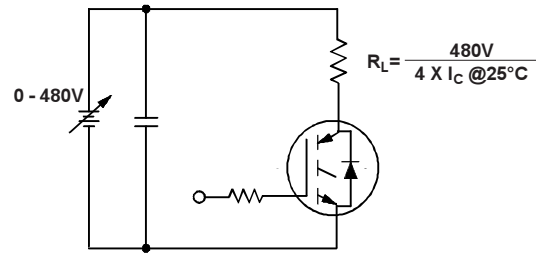


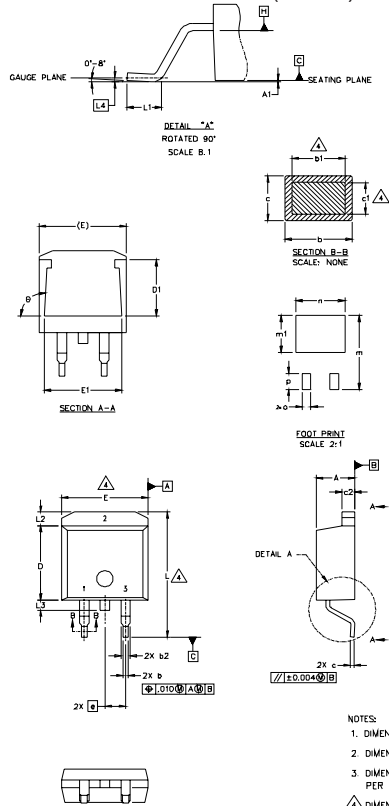
Figure 20. Pulsed Collector Current Test Circuit

# IRG4BC15UD-S/LPbF

International  
**IR** Rectifier

## D<sup>2</sup>Pak Package Outline

Dimensions are shown in millimeters (inches)



SYMBOL	DIMENSIONS				NOTES
	MILLIMETERS		INCHES		
	MIN.	MAX.	MIN.	MAX.	
A	4.06	4.83	.160	.190	
A1		0.127		.005	
b	0.51	0.99	.020	.039	
b1	0.51	0.89	.020	.035	4
b2	1.14	1.40	.045	.055	
c	0.43	0.63	.017	.025	
c1	0.38	0.74	.015	.029	4
c2	1.14	1.40	.045	.055	
D	8.51	9.65	.335	.380	3
D1	5.33		.210		
E	9.65	10.67	.380	.420	3
E1	6.22		.245		
e	2.54	BSC	.100	BSC	
L	14.61	15.88	.575	.625	
L1	1.78	2.79	.070	.110	
L2		1.65		.065	
L3	1.27	1.78	.050	.070	
L4		0.25 BSC		.010 BSC	
m	17.78		.700		
m1	8.89		.350		
n	11.43		.450		
o	2.08		.082		
p	3.81		.150		
θ	90°	93°	90°	93°	

### LEAD ASSIGNMENTS

HEXFET	IGBTs_CoPACK	DIODES
1- GATE	1- GATE	1- ANODE *
2- DRAIN	2- COLLECTOR	2- CATHODE
3- SOURCE	3- EMITTER	3- ANODE

\* PART DEPENDENT.

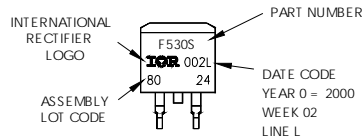
### NOTES:

1. DIMENSIONING AND TOLERANCING PER ASME Y14.5M-1994
2. DIMENSIONS ARE SHOWN IN MILLIMETERS [INCHES]
3. DIMENSION D & E DO NOT INCLUDE MOLD FLASH. MOLD FLASH SHALL NOT EXCEED 0.127 [0.005"] PER SIDE. THESE DIMENSIONS ARE MEASURED AT THE OUTMOST EXTREMES OF THE PLASTIC BODY.
4. DIMENSION b1 AND c1 APPLY TO BASE METAL ONLY.
5. CONTROLLING DIMENSION: INCH.

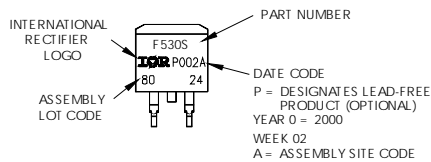
## D<sup>2</sup>Pak Part Marking Information

EXAMPLE: THIS IS AN IRF530S WITH  
LOT CODE 8024  
ASSEMBLED ON WW 02, 2000  
IN THE ASSEMBLY LINE "L"

Note: "P" in assembly line  
position indicates "Lead-Free"



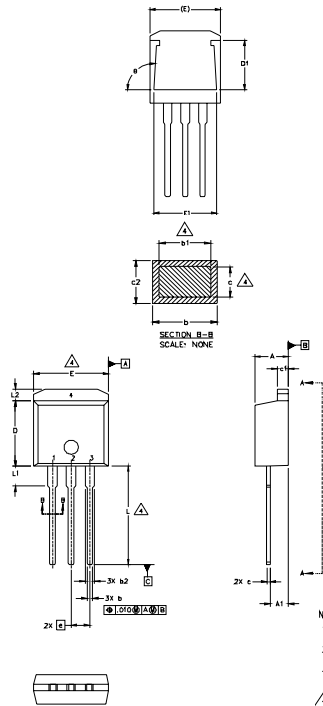
**OR**



P = DESIGNATES LEAD-FREE  
PRODUCT (OPTIONAL)  
YEAR 0 = 2000  
WEEK 02  
A = ASSEMBLY SITE CODE

## TO-262 Package Outline

Dimensions are shown in millimeters (inches)



SYMBOL	DIMENSIONS				NOTES
	MILLIMETERS		INCHES		
	MIN.	MAX.	MIN.	MAX.	
A	4.06	4.83	.160	.190	
A1	2.03	2.92	.080	.115	
b	0.51	0.99	.020	.039	
b1	0.51	0.89	.020	.035	4
b2	1.14	1.40	.045	.055	
c	0.38	0.63	.015	.025	4
c1	1.14	1.40	.045	.055	
c2	0.43	.063	.017	.029	
D	8.61	9.65	.335	.380	3
D1	5.33		.210		
E	9.65	10.67	.380	.420	3
E1	6.22		.245		
e	2.54 BSC		.100 BSC		
L	13.46	14.09	.530	.565	
L1	3.56	3.71	.140	.146	
L2		1.65		.065	

### LEAD ASSIGNMENTS

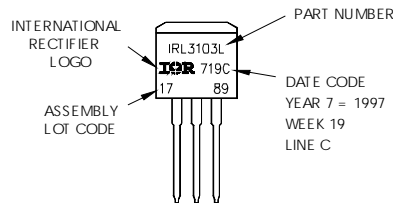
HEXFET	IGBT
1. - GATE	1 - GATE
2. - DRAIN	2 - COLLECTOR
3. - SOURCE	3 - EMITTER
4. - DRAIN	

- NOTES:
1. DIMENSIONING AND TOLERANCING PER ASME Y14.5M-1994
  2. DIMENSIONS ARE SHOWN IN MILLIMETERS [INCHES]
  3. DIMENSION D & E DO NOT INCLUDE MOLD FLASH. MOLD FLASH SHALL NOT EXCEED 0.127 [0.005] PER SIDE. THESE DIMENSIONS ARE MEASURED AT THE OUTMOST EXTREMES OF THE PLASTIC BODY.
  4. DIMENSION b1 AND c1 APPLY TO BASE METAL ONLY.
  5. CONTROLLING DIMENSION: INCH.

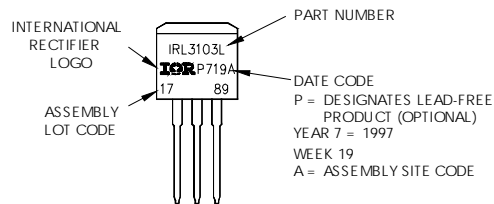
## TO-262 Part Marking Information

EXAMPLE: THIS IS AN IRL3103L  
LOT CODE 1789  
ASSEMBLED ON VW 19, 1997  
IN THE ASSEMBLY LINE "C"

Note: "P" in assembly line position indicates "Lead-Free"



OR

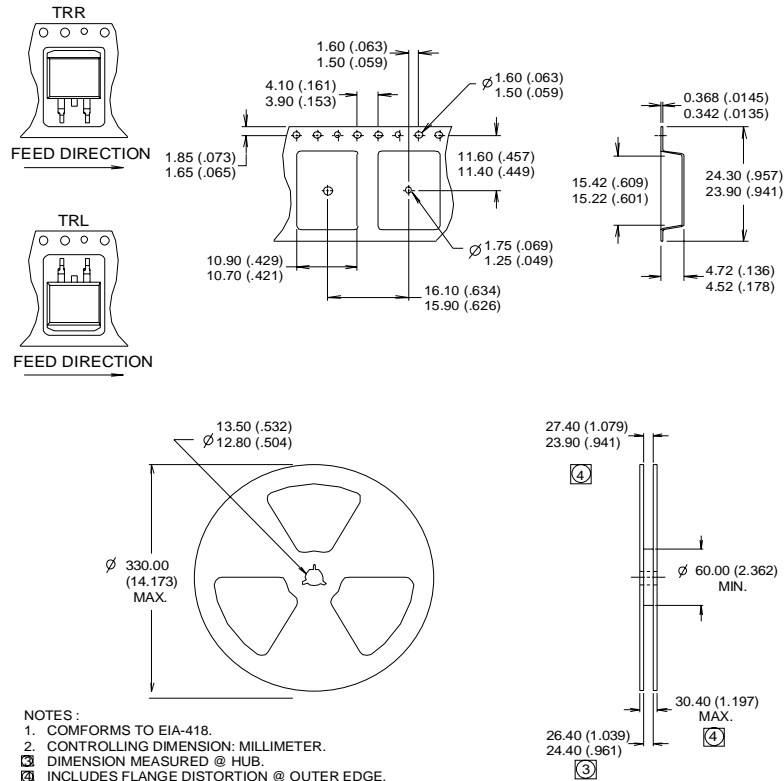


# IRG4BC15UD-S/LPbF

International  
**IR** Rectifier

## D<sup>2</sup>Pak Tape & Reel Information

Dimensions are shown in millimeters (inches)



- NOTES:
1. CONFORMS TO EIA-418.
  2. CONTROLLING DIMENSION: MILLIMETER.
  3. DIMENSION MEASURED @ HUB.
  4. INCLUDES FLANGE DISTORTION @ OUTER EDGE.

### Notes:

- ① Repetitive rating:  $V_{GE}=20V$ ; pulse width limited by maximum junction temperature.
- ②  $V_{CC}=80\%(V_{CES})$ ,  $V_{GE}=20V$ ,  $L=10\mu H$ ,  $R_G = 75\Omega$
- ③ Pulse width  $\leq 80\mu s$ ; duty factor  $\leq 0.1\%$ .
- ④ Pulse width  $5.0\mu s$ , single shot.
- ⑤ This only applies to TO-262 package.

⑥ This applies to D<sup>2</sup>Pak, when mounted on 1" square PCB (FR-4 or G-10 Material). For recommended footprint and soldering techniques refer to application note #AN-994.

Data and specifications subject to change without notice.  
This product has been designed and qualified for the Industrial market.  
Qualification Standards can be found on IR's Web site.

International  
**IR** Rectifier

IR WORLD HEADQUARTERS: 233 Kansas St., El Segundo, California 90245, USA Tel: (310) 252-7105  
TAC Fax: (310) 252-7903

Visit us at [www.irf.com](http://www.irf.com) for sales contact information.08/04

Note: For the most current drawings please refer to the IR website at:  
<http://www.irf.com/package/>