

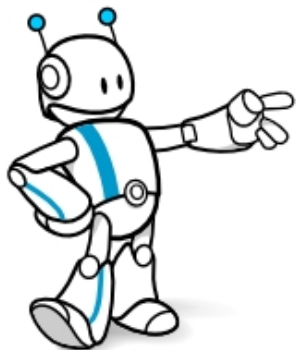

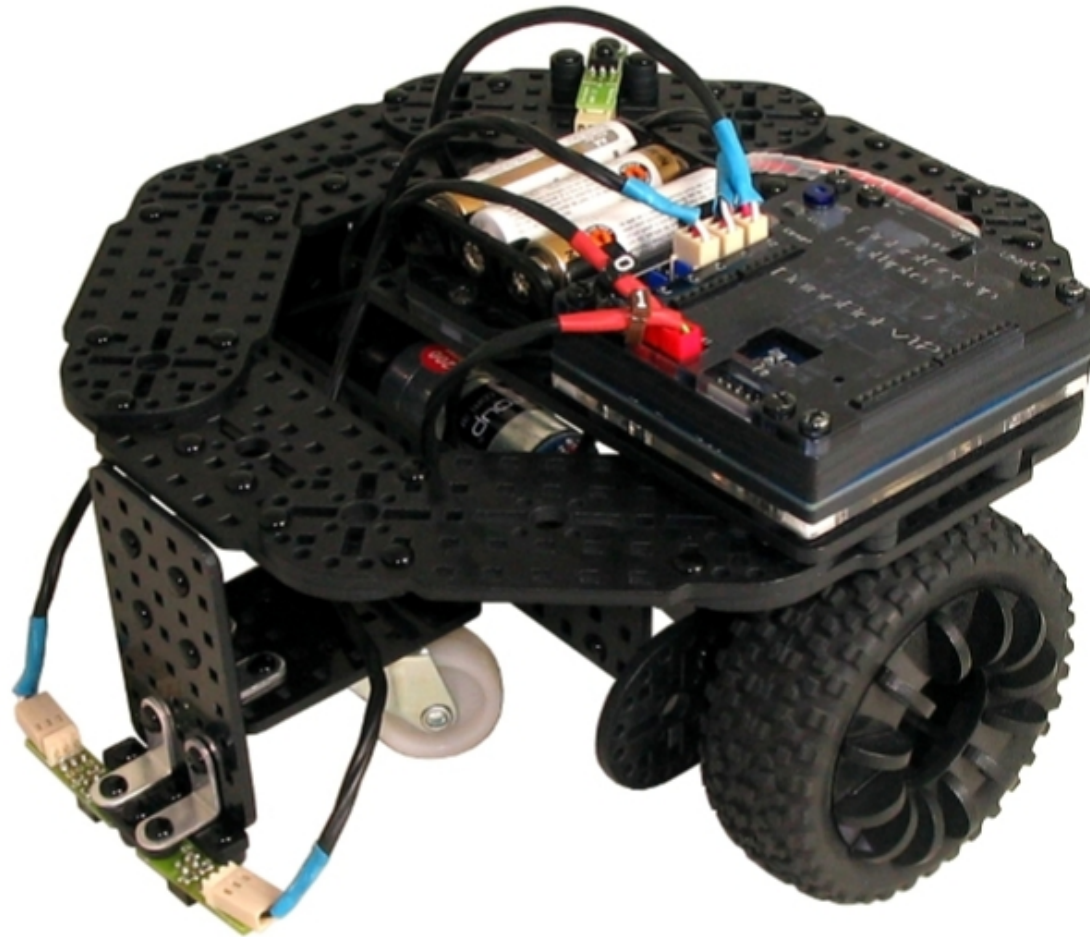

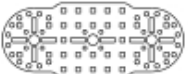

Starter Kit: octagonal robot assembly guide

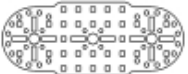

- 1  2x
3x  3080
- 2  3x
9x  3080
- 3  3x
12x  3080

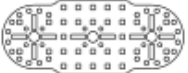

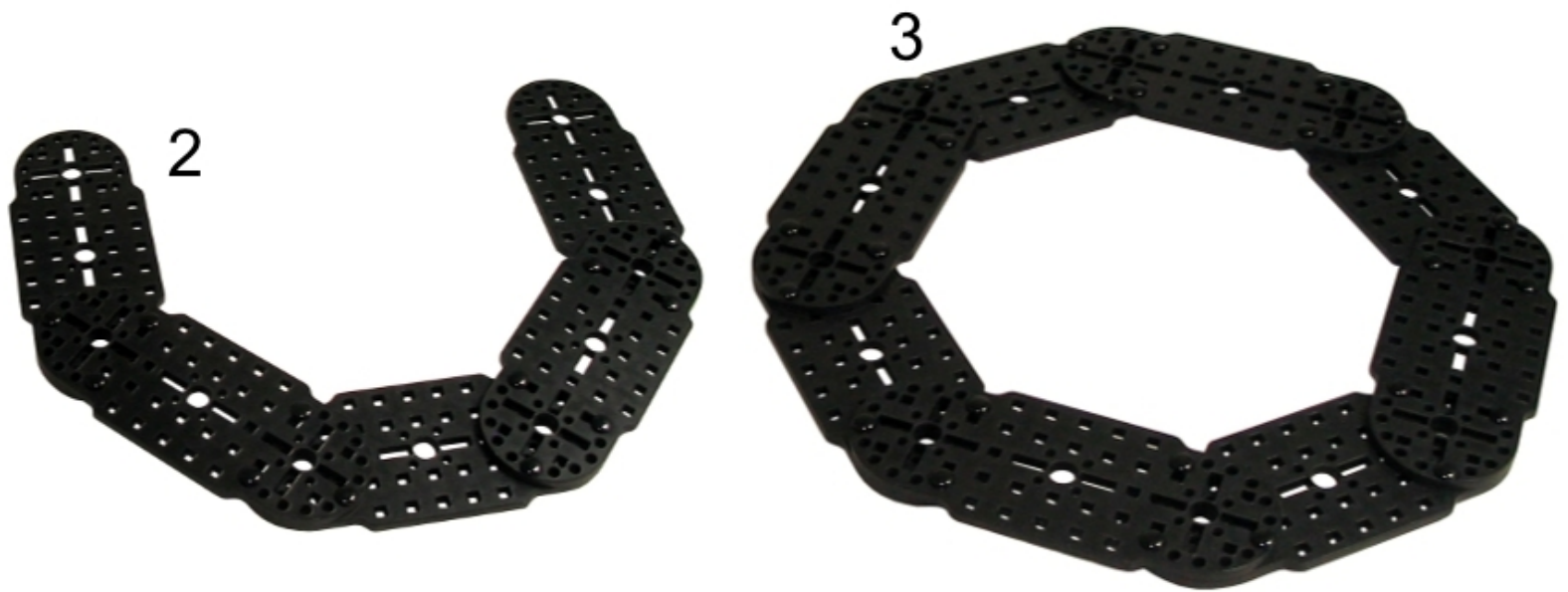
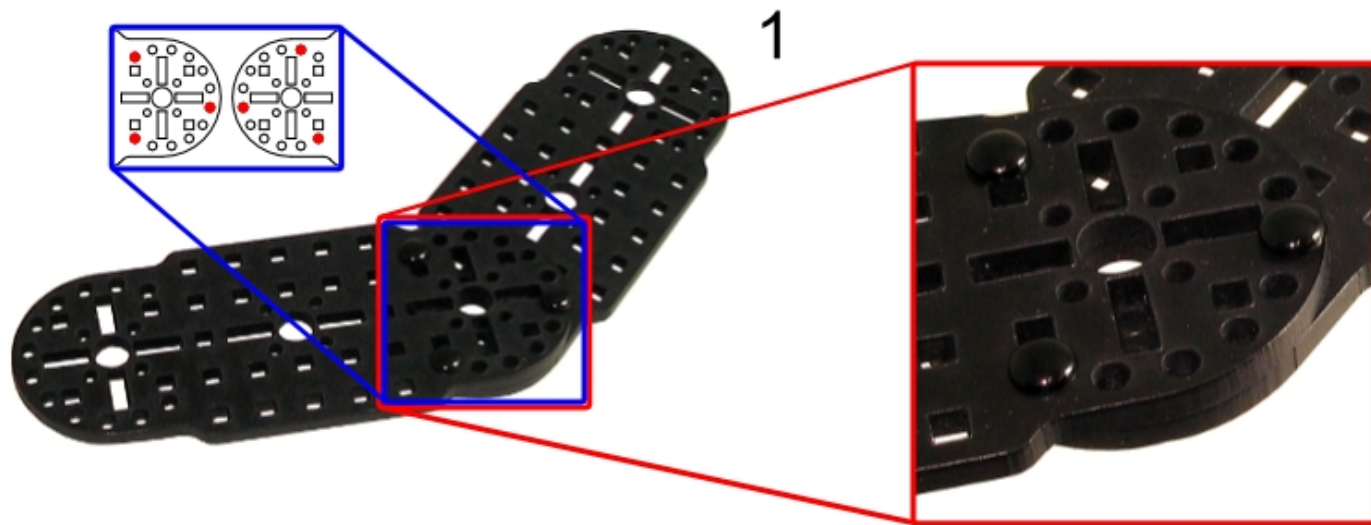
4

1x 

2x 

1x 

5

1x 

2x  (14mm)

6

2x 

2x  3100

7

1x 

2x 

1x 

8

1x 

2x  (14mm)

9

2x 

2x  3100

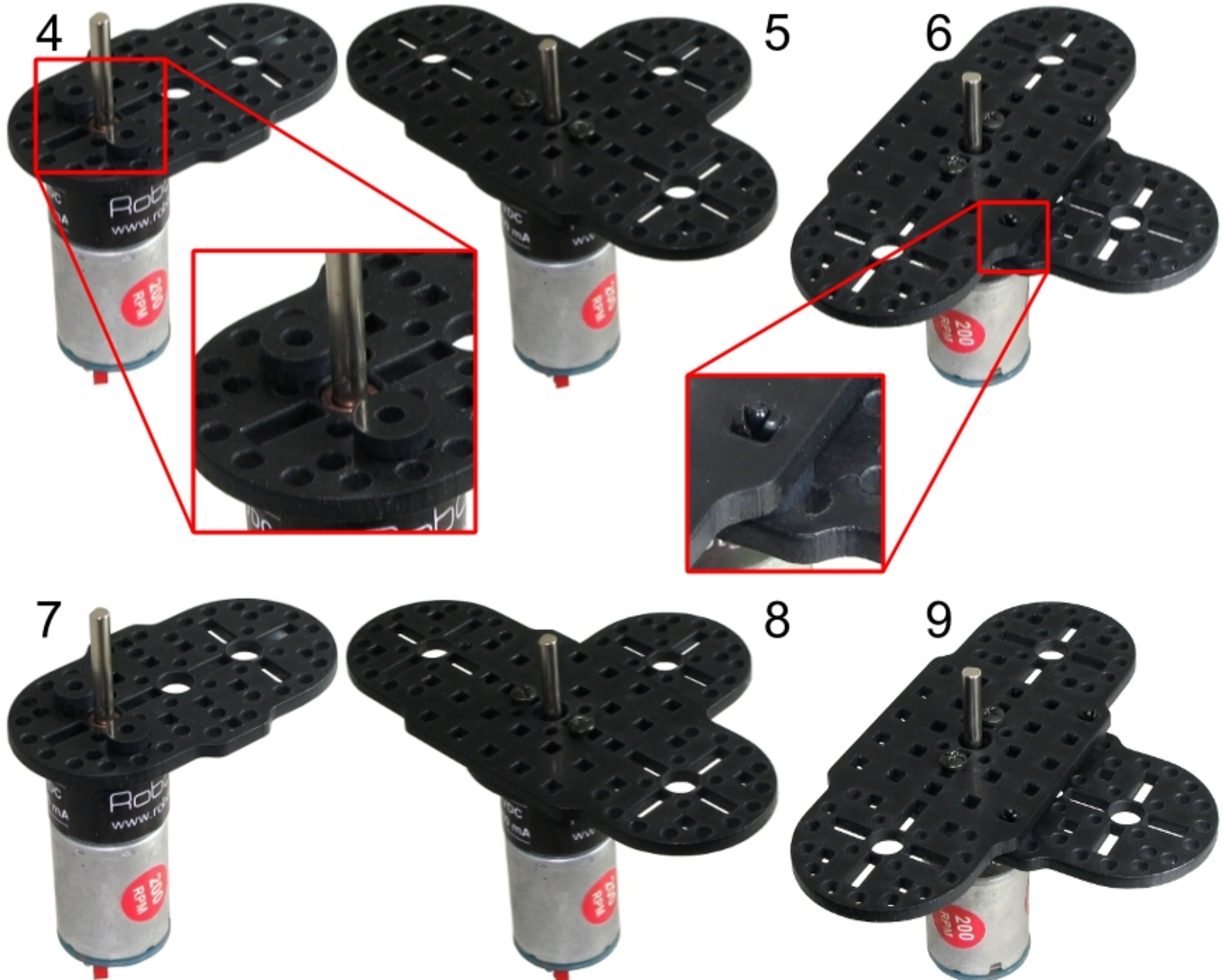

10



1x



4x 3065

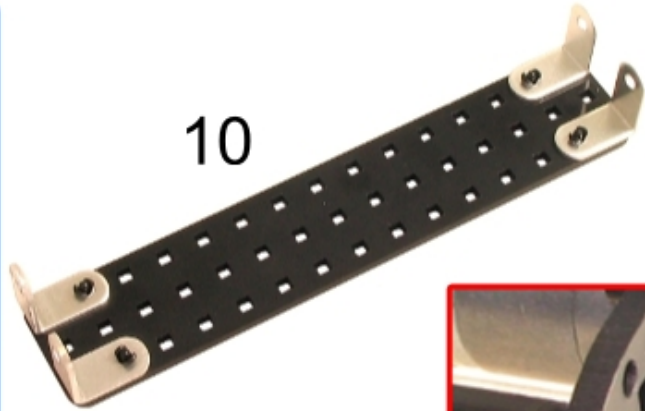

10

11

4x 3065

12

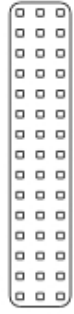

1x



2x 3065



12

13

2x 3065

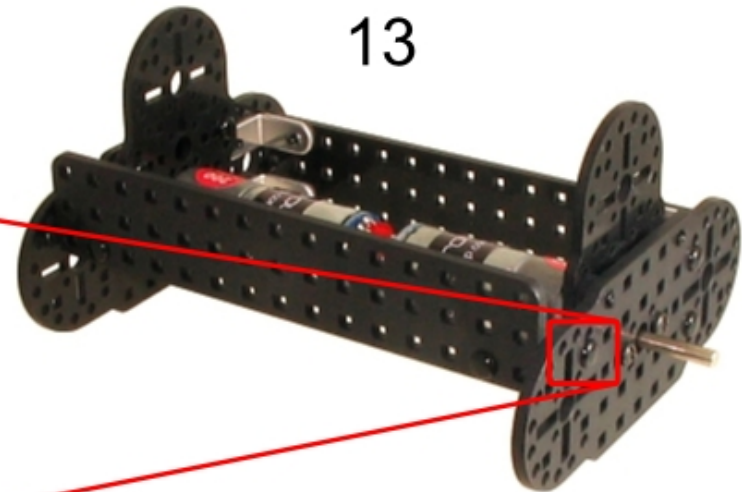

13

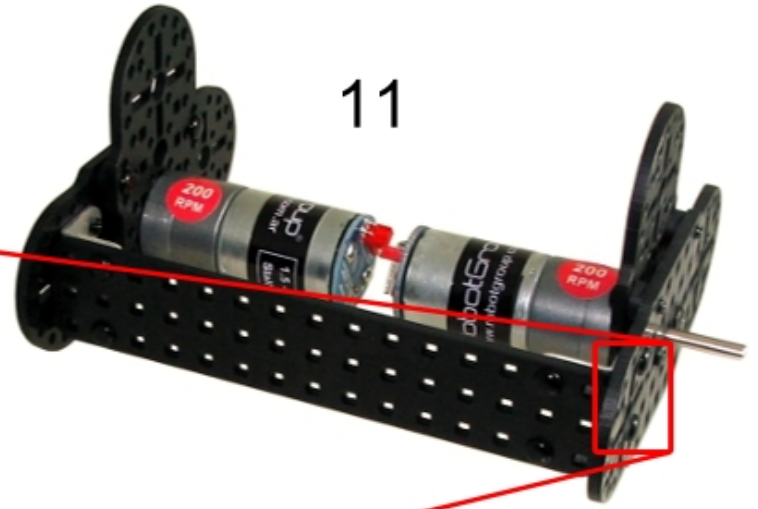

11

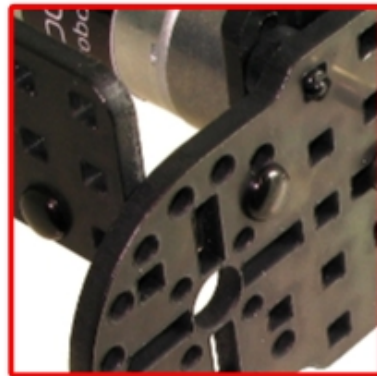
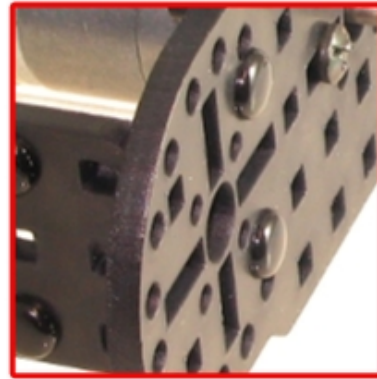



14 4x 

4x  3065

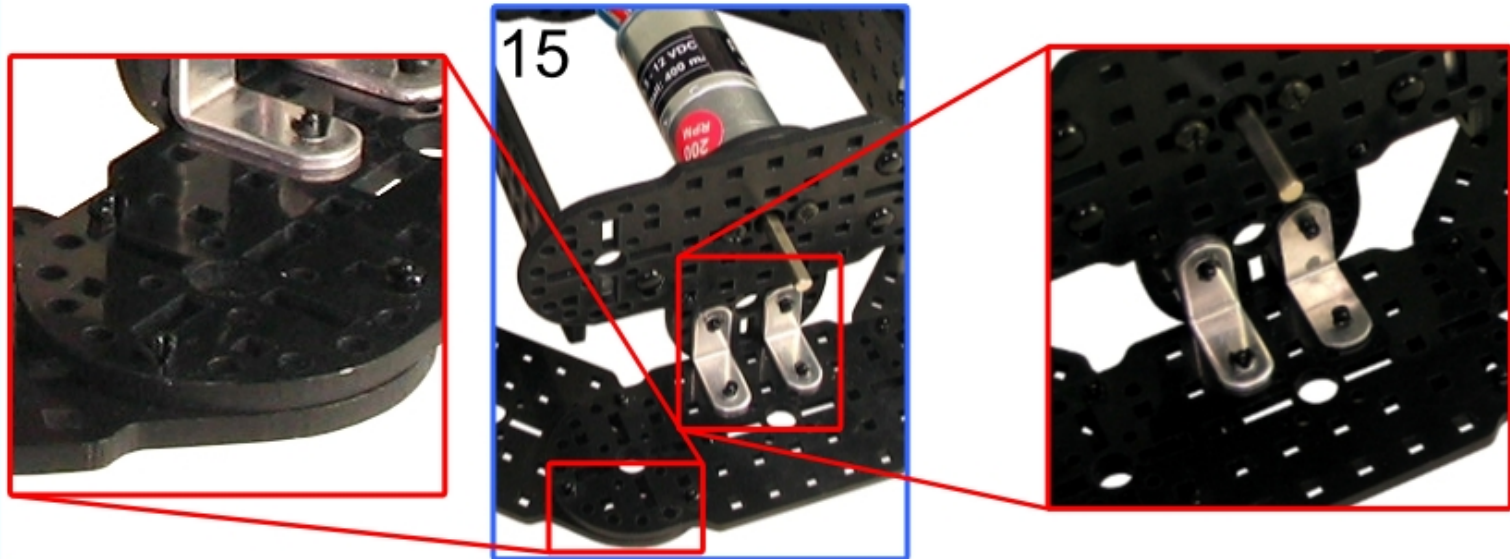
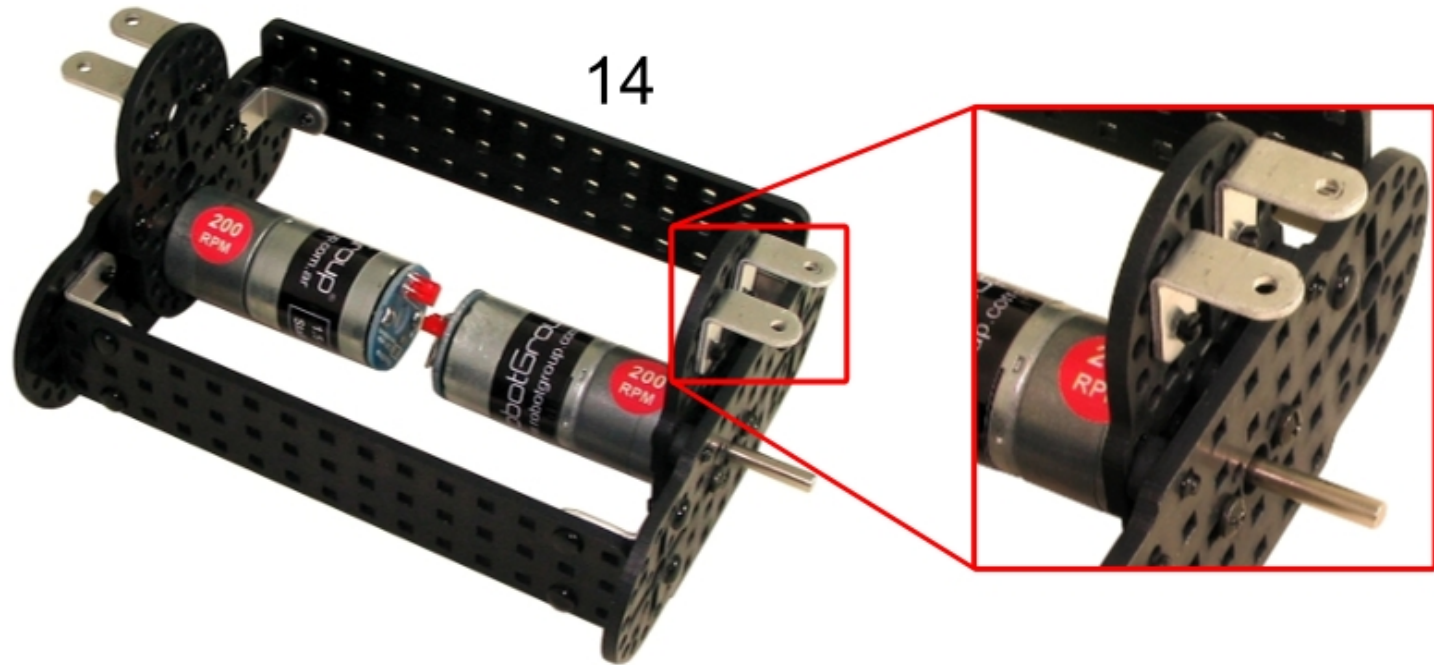
15 4x  3065





16

- 1x 
- 4x 
- 4x 

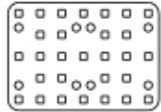

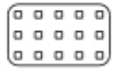

17

- 2x 
- 1x 

18

- 1x 
- 4x 
- 6x 

19

- 1x 
- 1x 
- 1x 
- 1x 

20

- 4x 

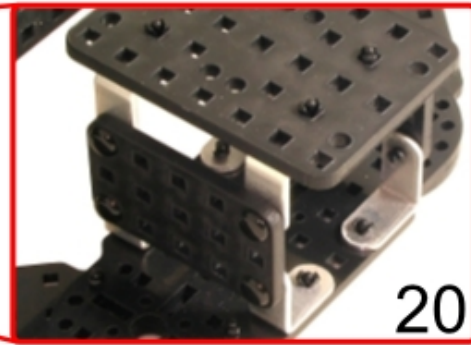
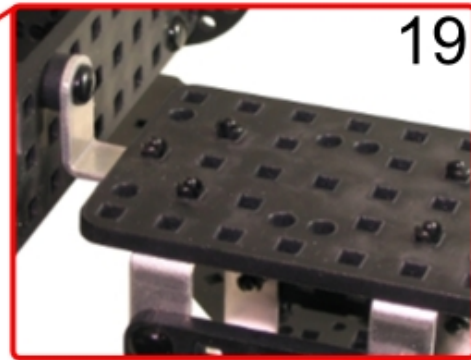
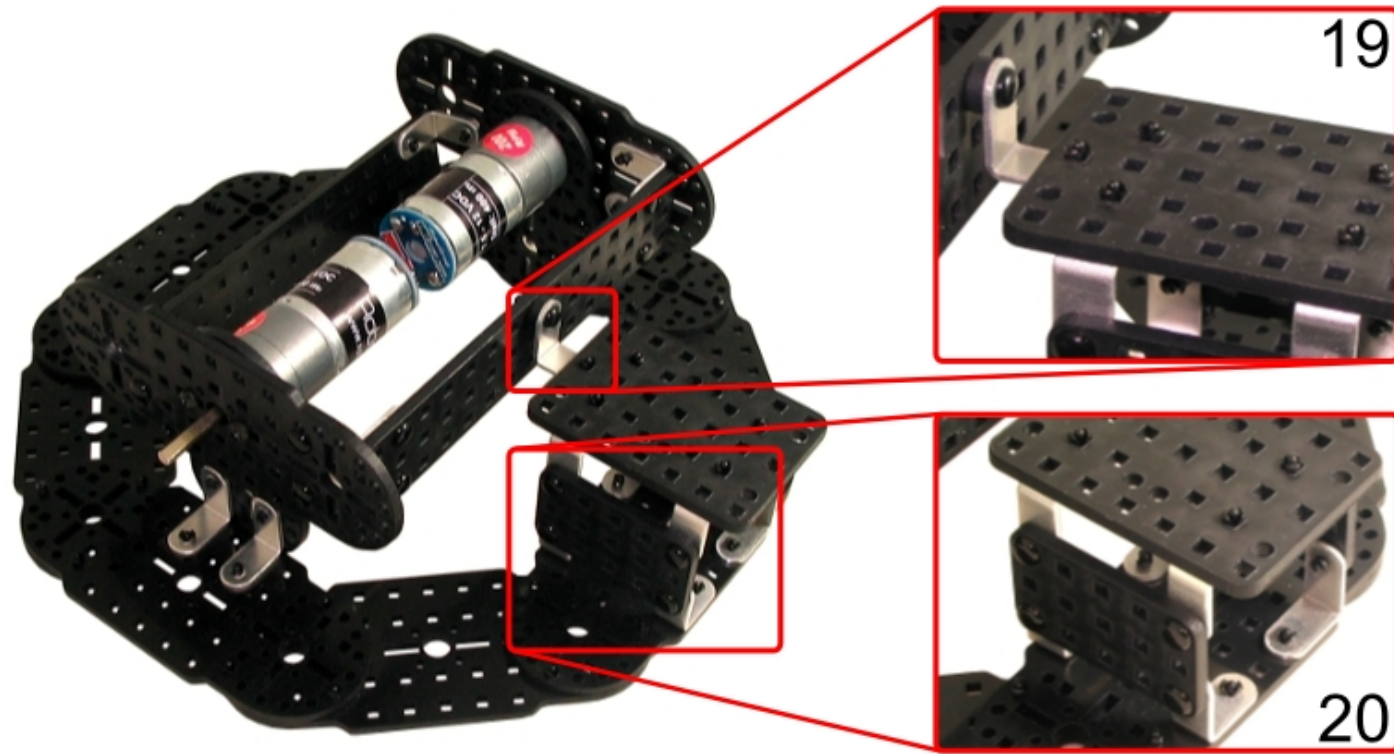
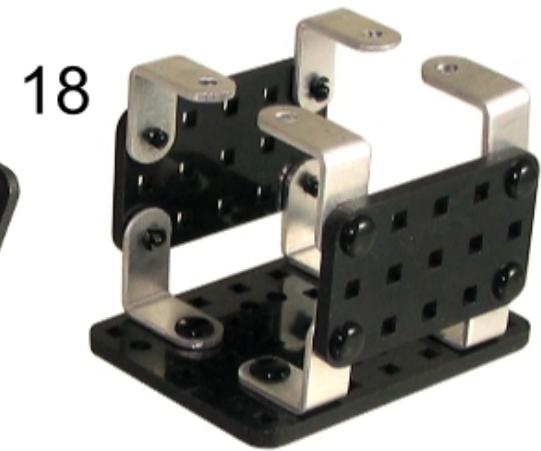
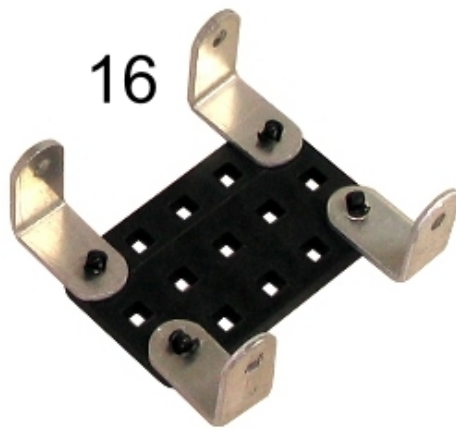

21 5x 

7x  3065

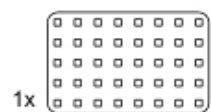
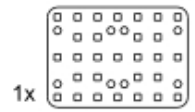

22 1x 

1x  3065

1x  3100

1x 

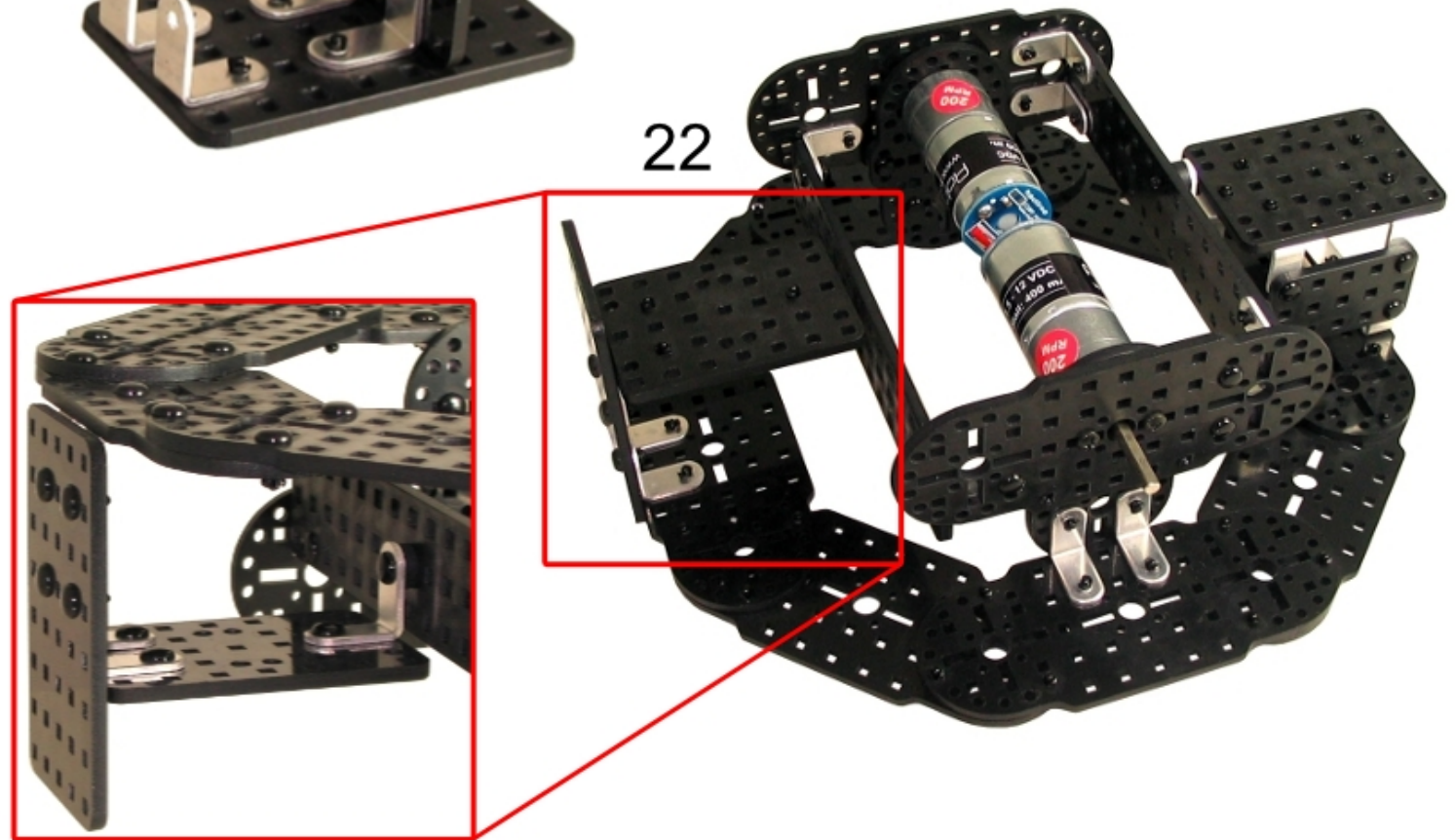
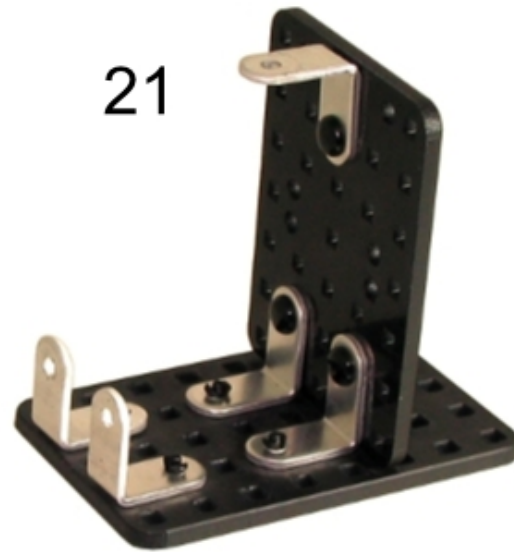

23



1x

4x T 3080

4x Ⓞ

24



1x

4x T 3080

4x Ⓞ

23

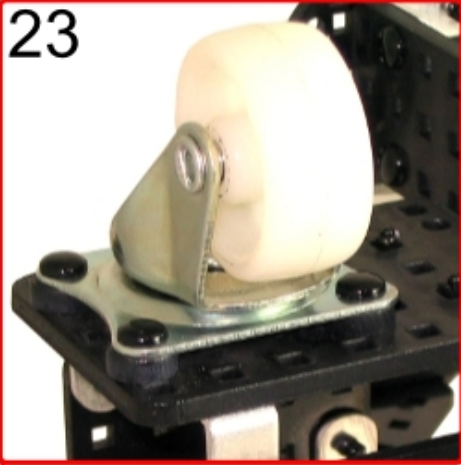

24

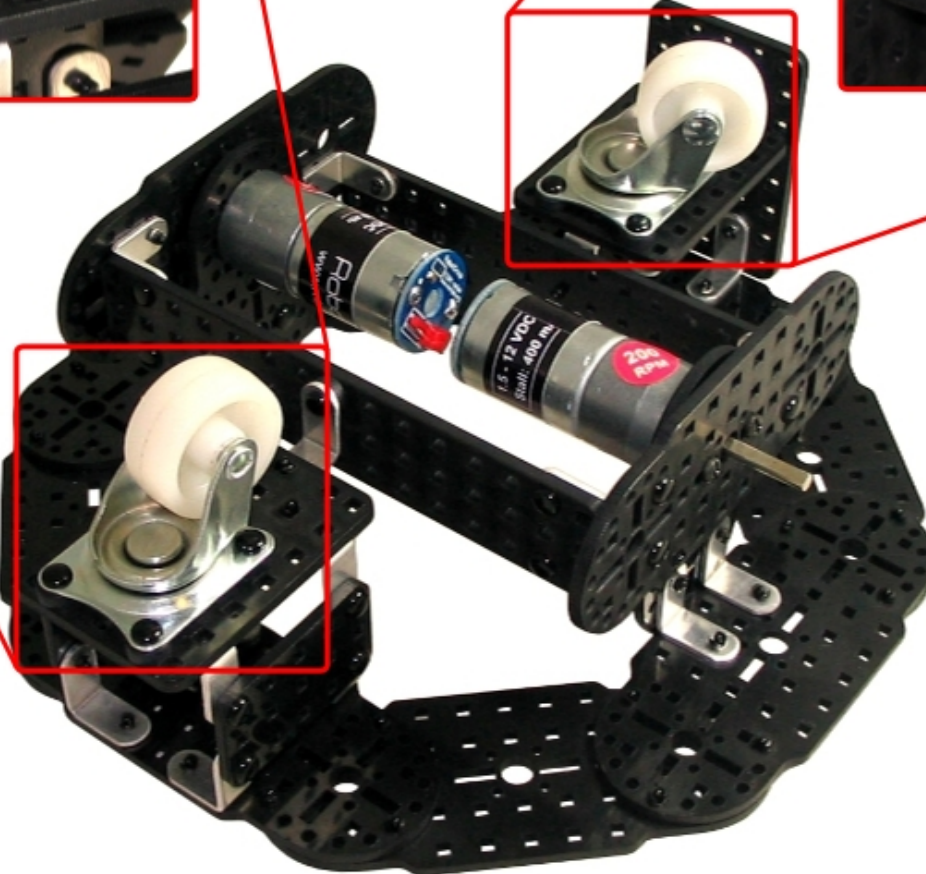

25

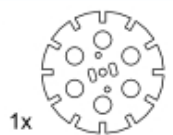

1x



1x



2x



2x

26

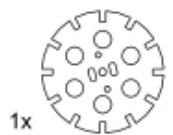

1x



1x



2x



2x

27



1x

28



1x

29



1x



2x

30

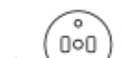

1x



2x



25



26



27



28













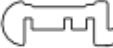

29

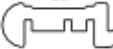

30



31	1x 
	1x 
	1x 
32	7x 
33	4x 
34	1x 
	1x 
	1x 
32	7x 
33	4x 
37	1x 
38	1x 
	



39 2x ©

40 2x ©

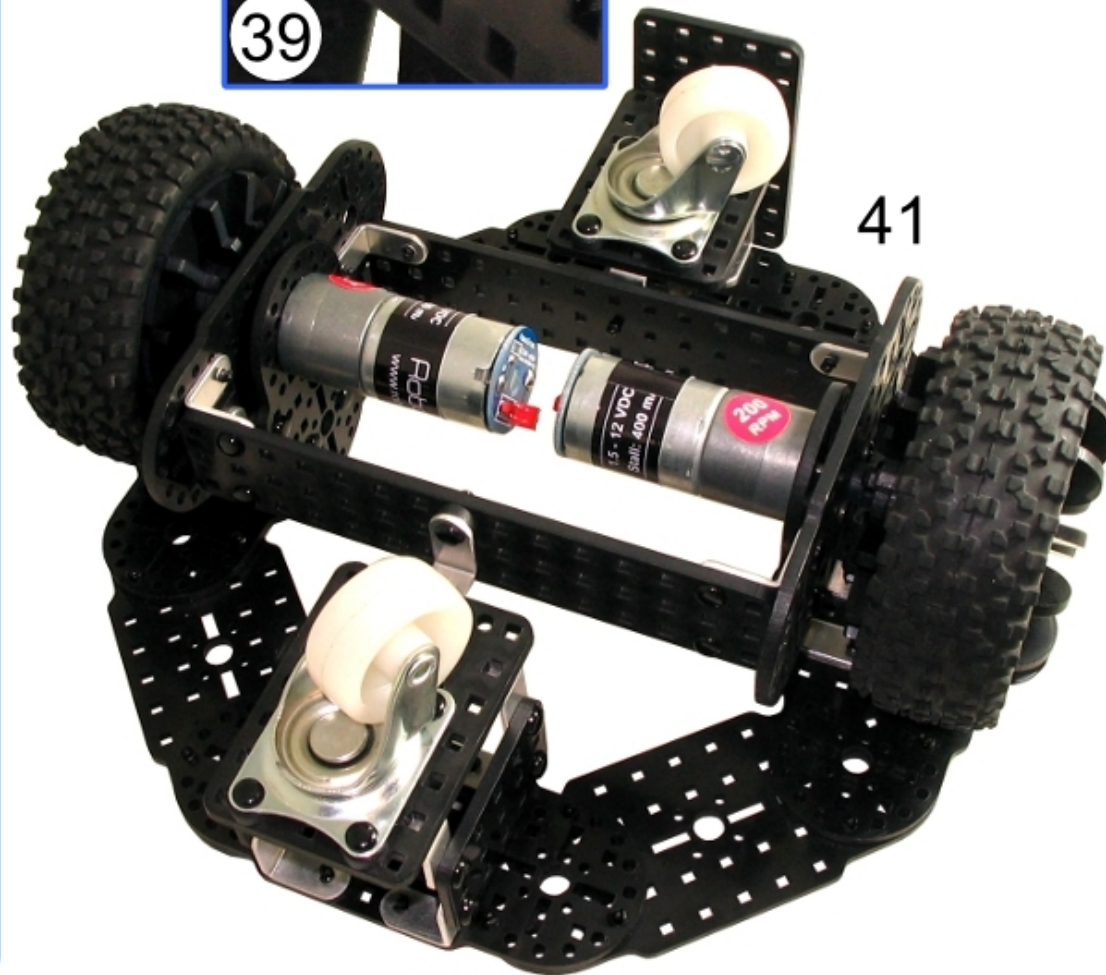
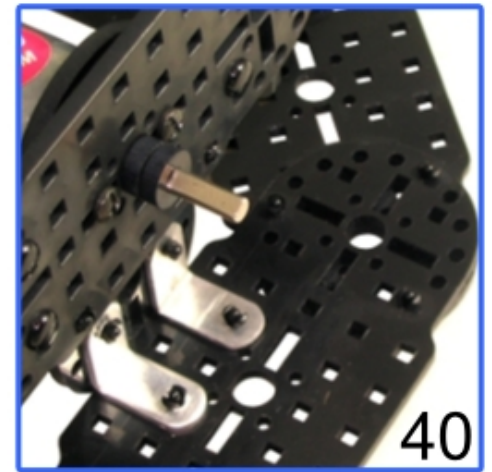
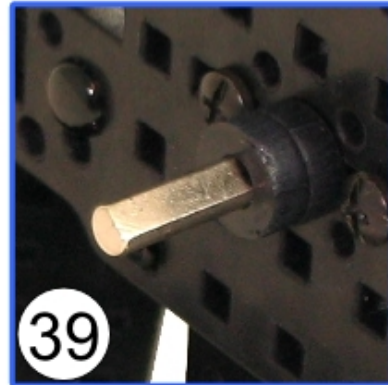

43



1x

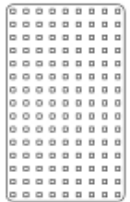

1x

4x ⊙

4x ↑ (30mm) 4x ⊙

44



1x

4x ↑ 3080

45

4x ↑ 3145

8x ⊙



43

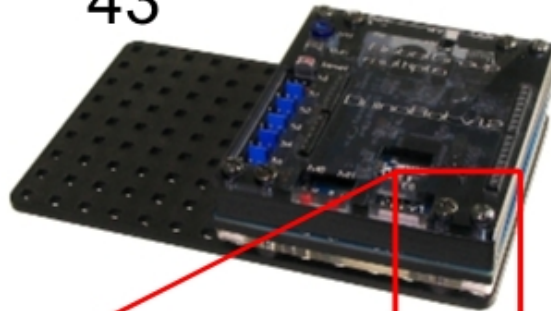





44

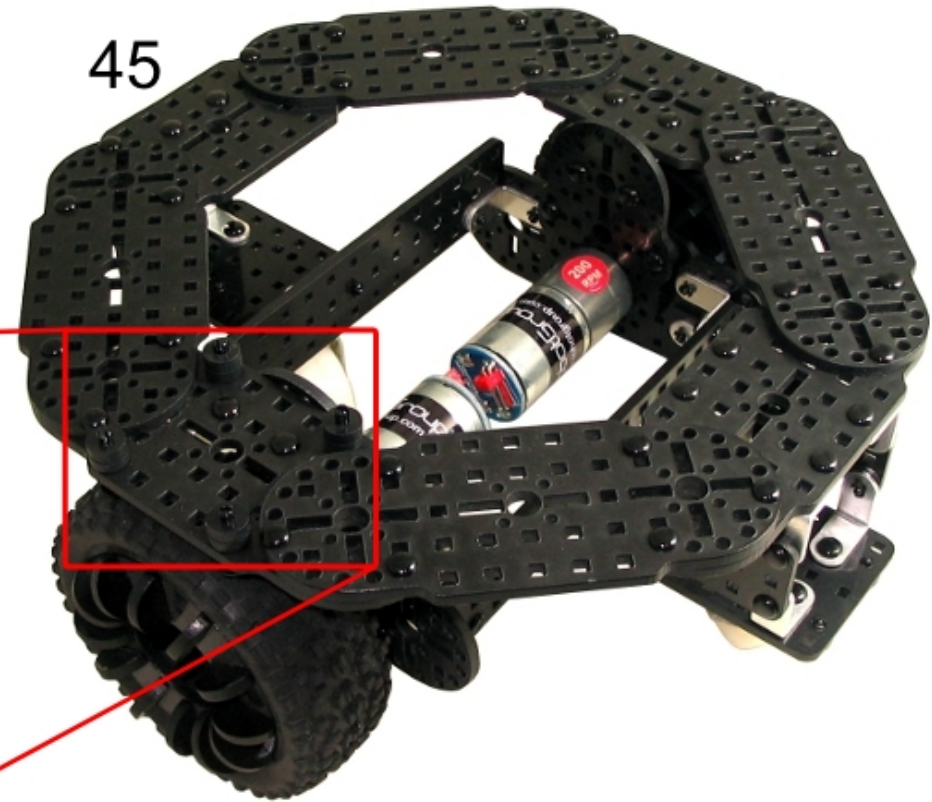

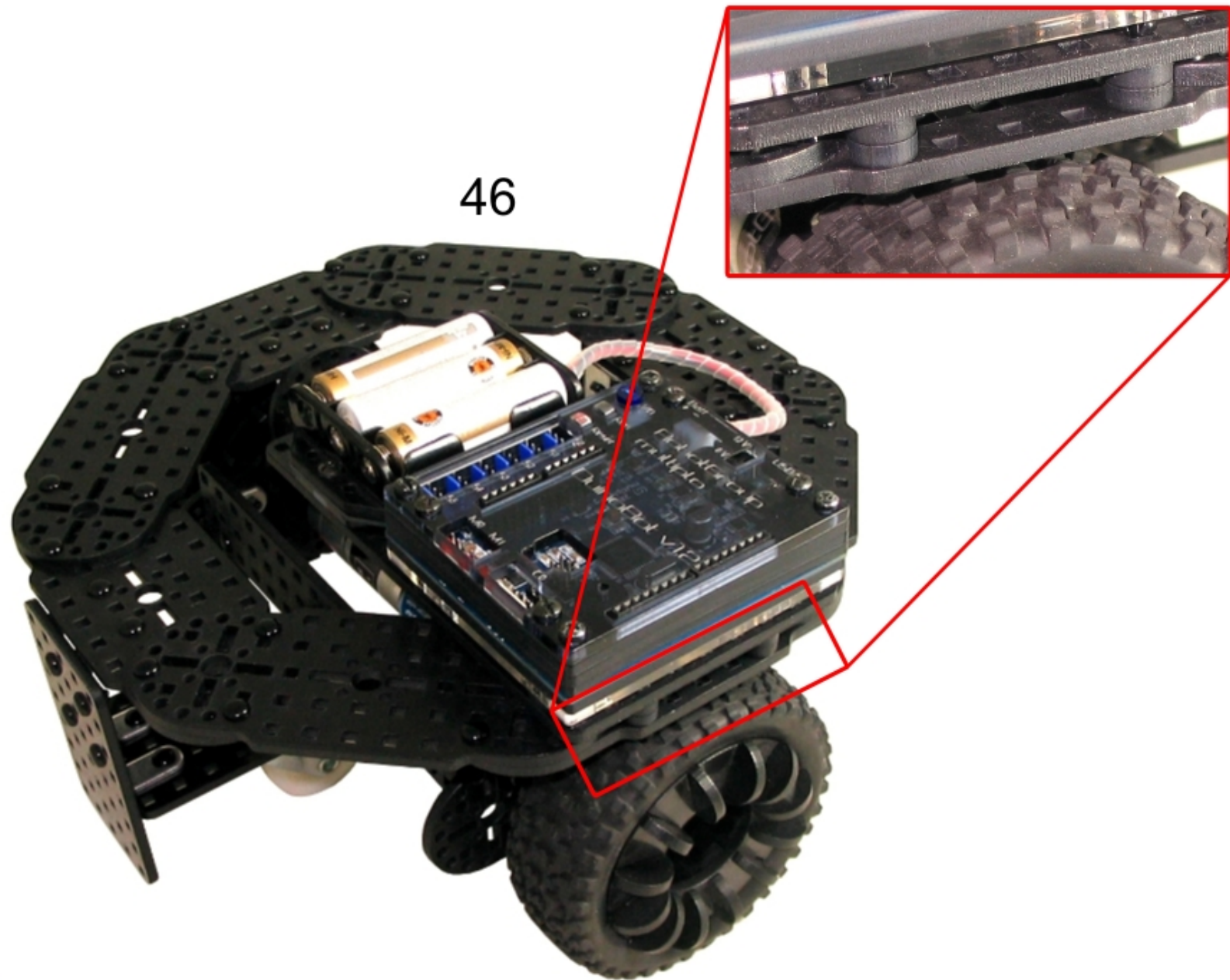

45





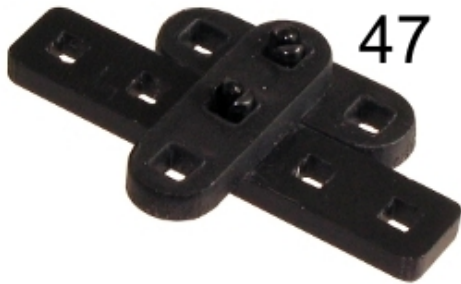

47 2x  3080
2x 
1x 





48 2x  3080
2x 

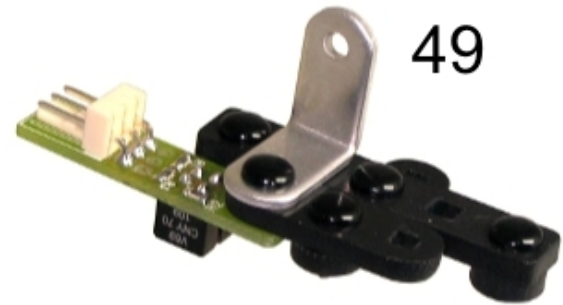

49 1x  3080
1x 
1x 



50 1x  3080
1x 
1x 

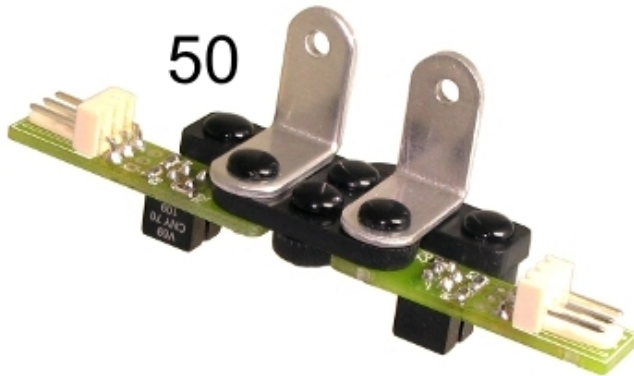

51 2x 

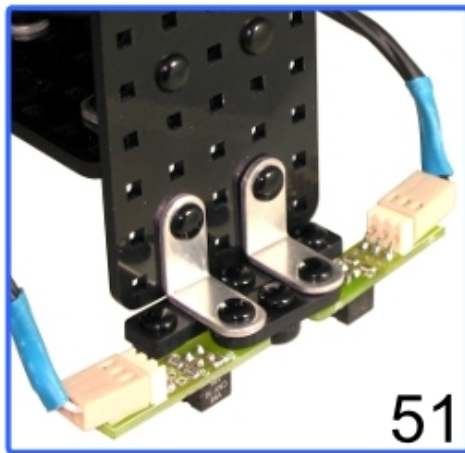

52 2x 

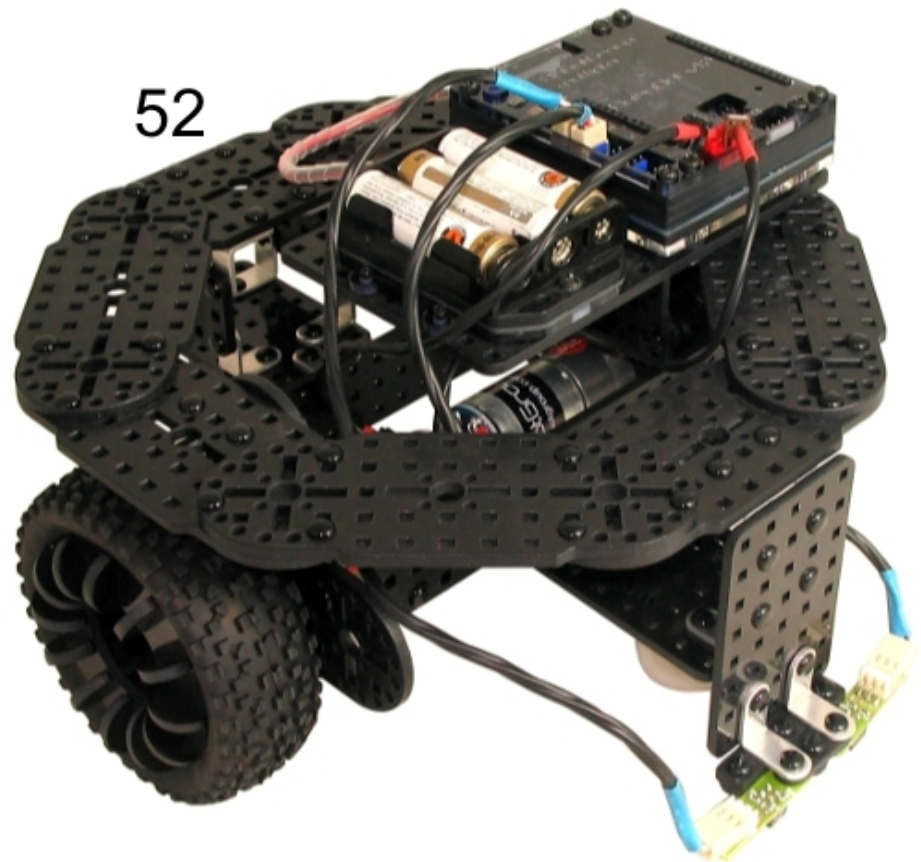

53 2x T 3145

6x ⊙

54 1x T 3145

2x ⊙

1x

1x

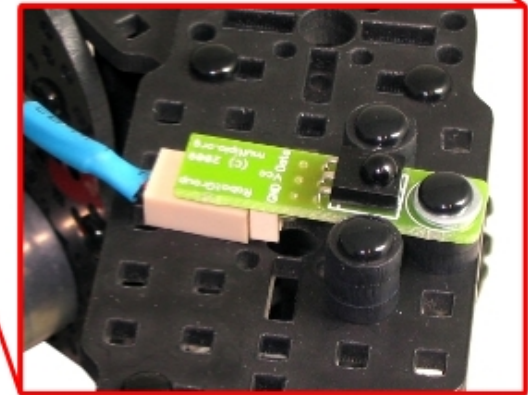
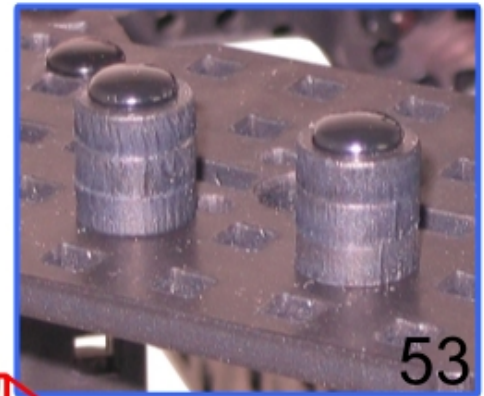
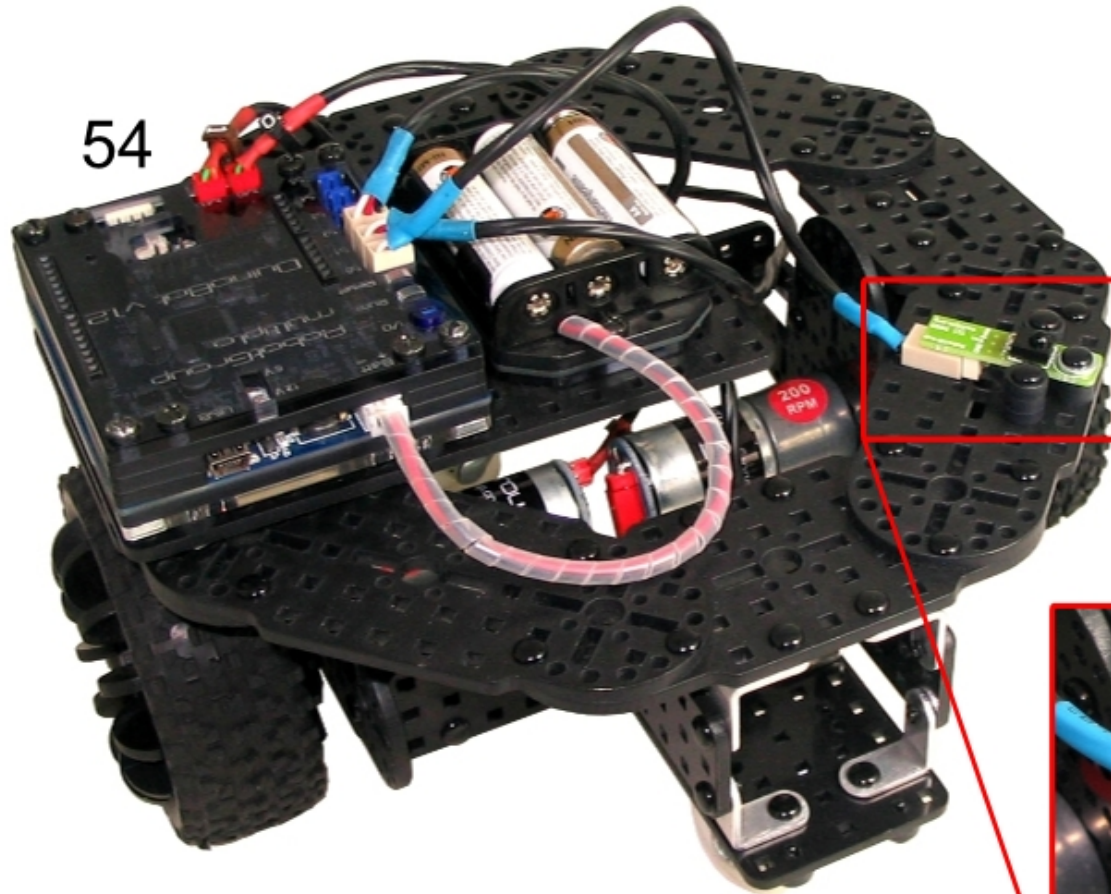

Designed by RobotGroup Argentina. (c) 2010-2012 Mónica J. Paves Palacios and Julián U. da Silva Gillig (<http://robotgroup.com.ar>). Produced by Multiplo LLC. This document is distributed under the RobotGroup-Multiplo Pacifist License (RMPL), either version 1.0 of the licence, or (at your option) any later version. The last version of this license can be downloaded from <http://miniblog.org>.