

PART NAME

JUNCTION BOX w/ HINGED COVER & KNOCKOUTS

PART No.

JBH-4959-KO

REVISION DATE

7-18-11

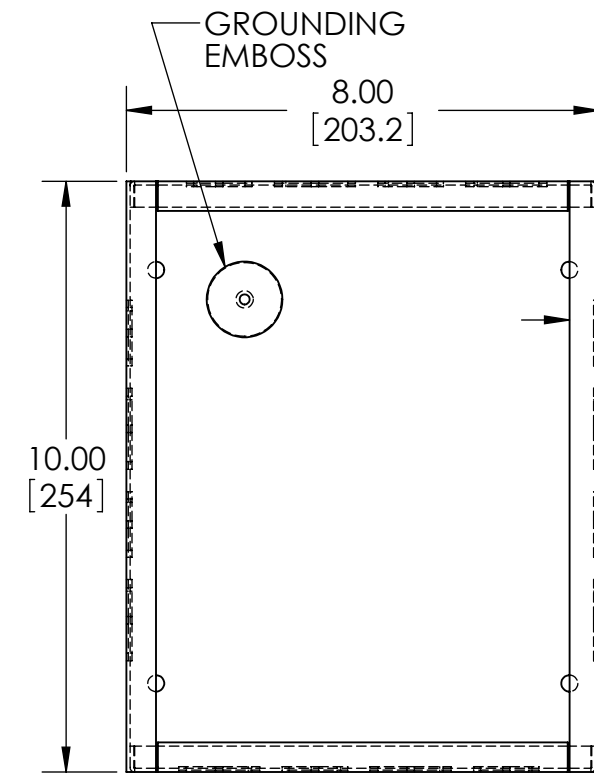
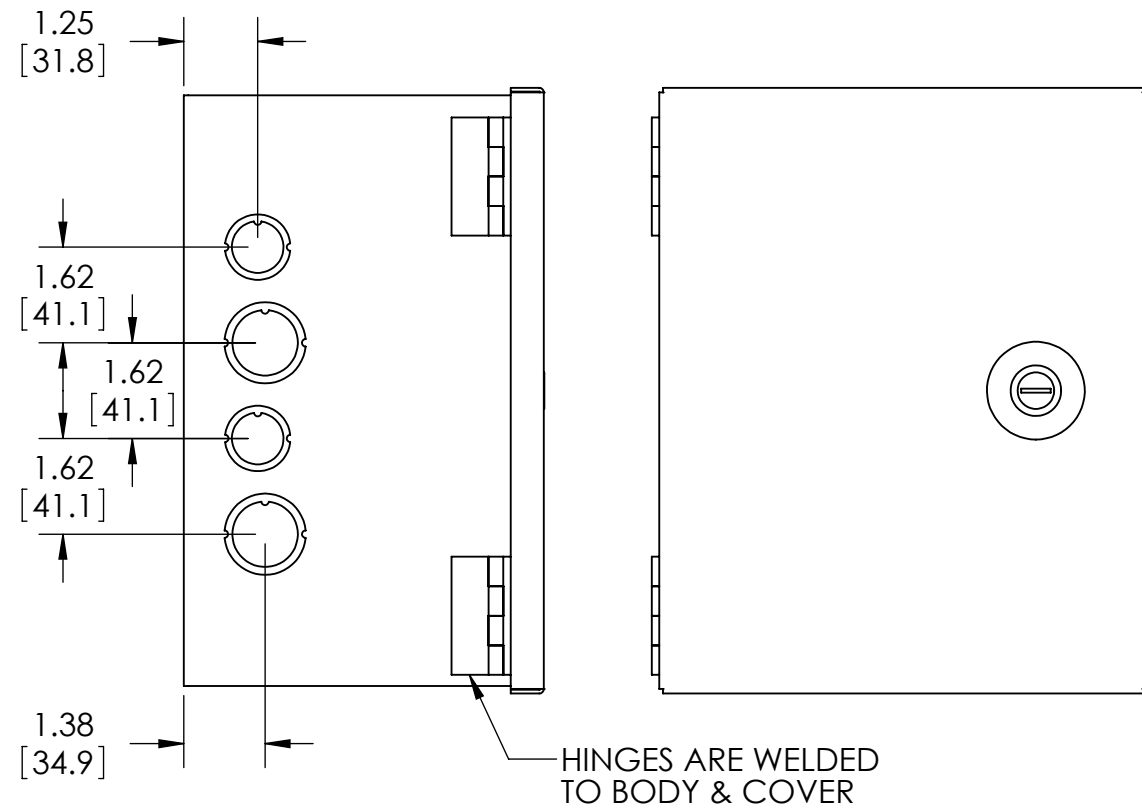
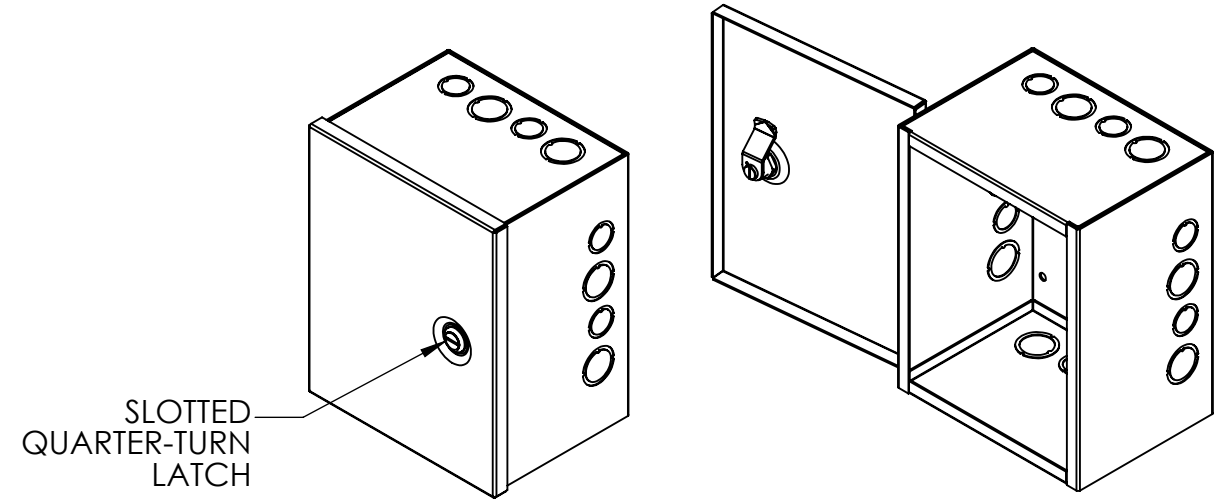
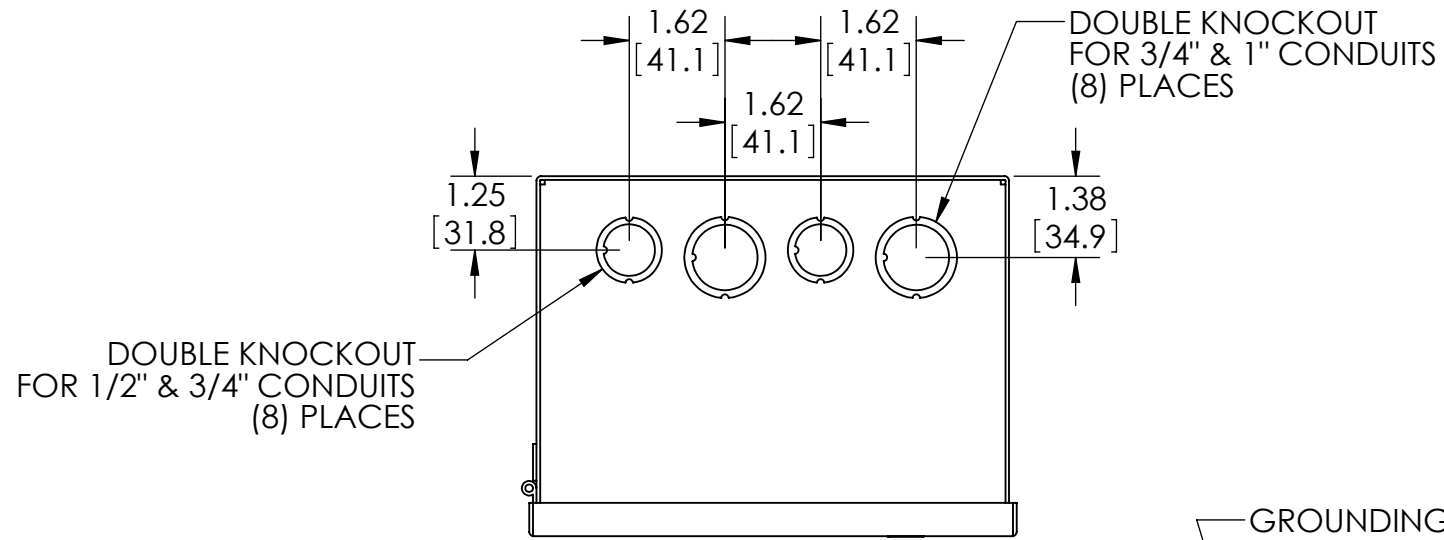

COVER NOT SHOWN THIS VIEW

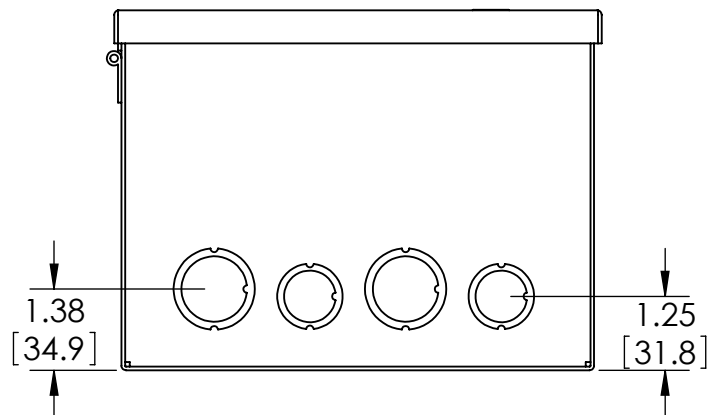
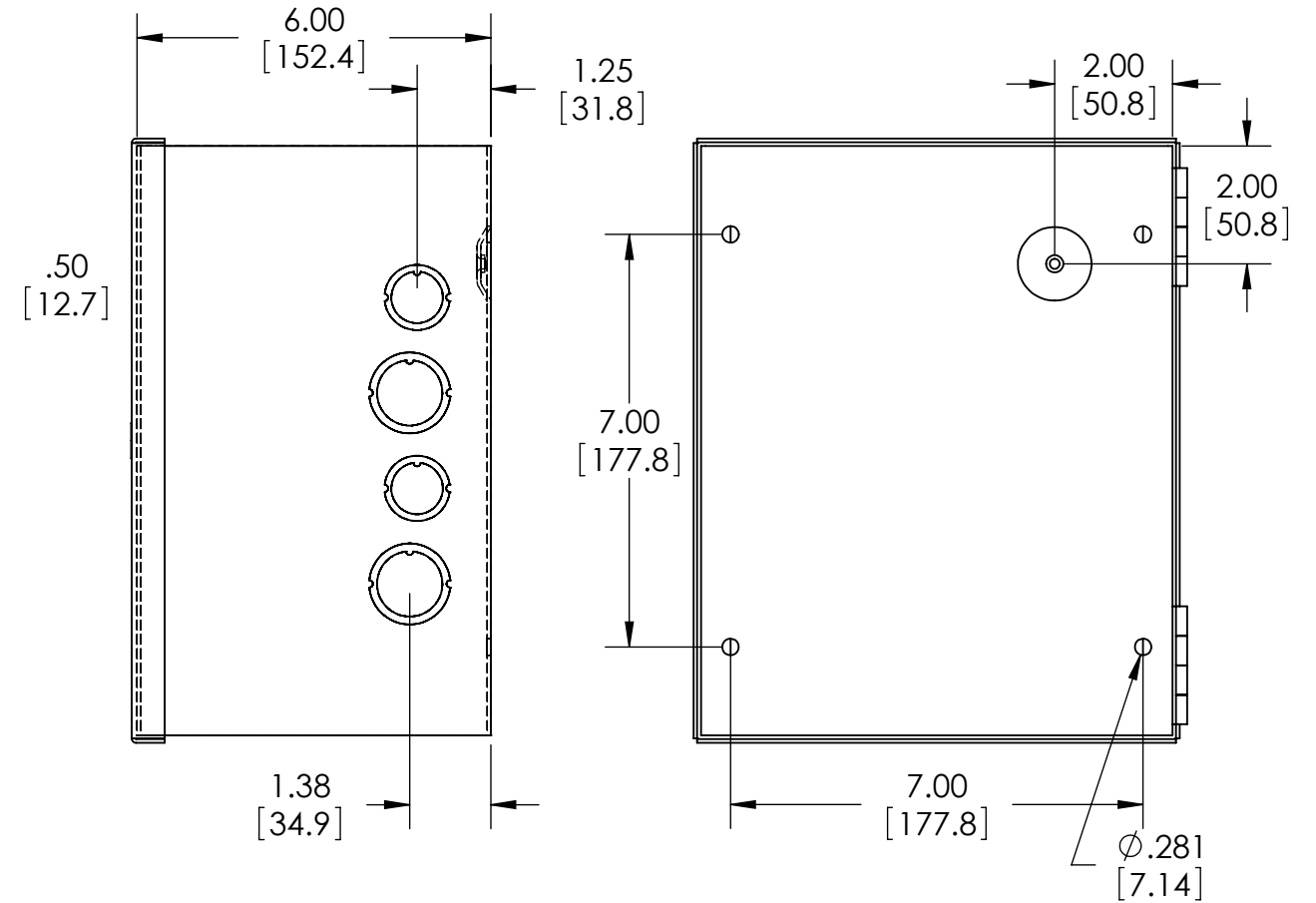

MATERIAL - 16 GA. [1.5mm] STEEL

FINISH - SMOOTH GRAY POWDERCOAT

INCLUDES ONE (1) #10-32 x .31"[8mm] LG. MACHINE, PAN HEAD, SLOTTED/SQUARE COMBINATION STYLE DRIVE, STEEL, ZINC PLATED SCREW FOR GROUND POINT.