



User Manual

IDS-3217 Series

**17" Industrial Panel Mount
Monitor**

ADVANTECH

Enabling an Intelligent Planet

Copyright

The documentation and the software included with this product are copyrighted 2015 by Advantech Co., Ltd. All rights are reserved. Advantech Co., Ltd. reserves the right to make improvements in the products described in this manual at any time without notice. No part of this manual may be reproduced, copied, translated or transmitted in any form or by any means without the prior written permission of Advantech Co., Ltd. Information provided in this manual is intended to be accurate and reliable. However, Advantech Co., Ltd. assumes no responsibility for its use, nor for any infringements of the rights of third parties, which may result from its use.

Acknowledgements

Intel and Pentium are trademarks of Intel Corporation.

Microsoft Windows and MS-DOS are registered trademarks of Microsoft Corp.

All other product names or trademarks are properties of their respective owners.

Product Warranty (2 years)

Advantech warrants to you, the original purchaser, that each of its products will be free from defects in materials and workmanship for two years from the date of purchase.

This warranty does not apply to any products which have been repaired or altered by persons other than repair personnel authorized by Advantech, or which have been subject to misuse, abuse, accident or improper installation. Advantech assumes no liability under the terms of this warranty as a consequence of such events.

Because of Advantech's high quality-control standards and rigorous testing, most of our customers never need to use our repair service. If an Advantech product is defective, it will be repaired or replaced at no charge during the warranty period. For out-of-warranty repairs, you will be billed according to the cost of replacement materials, service time and freight. Please consult your dealer for more details.

If you think you have a defective product, follow these steps:

1. Collect all the information about the problem encountered. (For example, CPU speed, Advantech products used, other hardware and software used, etc.) Note anything abnormal and list any onscreen messages you get when the problem occurs.
2. Call your dealer and describe the problem. Please have your manual, product, and any helpful information readily available.
3. If your product is diagnosed as defective, obtain an RMA (return merchandise authorization) number from your dealer. This allows us to process your return more quickly.
4. Carefully pack the defective product, a fully-completed Repair and Replacement Order Card and a photocopy proof of purchase date (such as your sales receipt) in a shippable container. A product returned without proof of the purchase date is not eligible for warranty service.
5. Write the RMA number visibly on the outside of the package and ship it prepaid to your dealer.

Part Number: 2006321700

Printed in Taiwan

Edition 1

November 2015

Declaration of Conformity

CE

This product has passed the CE test for environmental specifications. Test conditions for passing included the equipment being operated within an industrial enclosure. In order to protect the product from being damaged by ESD (Electrostatic Discharge) and EMI leakage, we strongly recommend the use of CE-compliant industrial enclosure products.

FCC Class A

Note: This equipment has been tested and found to comply with the limits for a Class A digital device, pursuant to part 15 of the FCC Rules. These limits are designed to provide reasonable protection against harmful interference when the equipment is operated in a commercial environment. This equipment generates, uses, and can radiate radio frequency energy and, if not installed and used in accordance with the instruction manual, may cause harmful interference to radio communications. Operation of this equipment in a residential area is likely to cause harmful interference in which case the user will be required to correct the interference at his own expense.

FM

This equipment has passed the FM certification. According to the National Fire Protection Association, work sites are classified into different classes, divisions and groups, based on hazard considerations. This equipment is compliant with the specifications of Class I, Division 2, Groups A, B, C and D indoor hazards.

Technical Support and Assistance

1. Visit the Advantech website at <http://support.advantech.com> where you can find the latest information about the product.
2. Contact your distributor, sales representative, or Advantech's customer service center for technical support if you need additional assistance. Please have the following information ready before you call:
 - Product name and serial number
 - Description of your peripheral attachments
 - Description of your software (operating system, version, application software, etc.)
 - A complete description of the problem
 - The exact wording of any error messages

Warnings, Cautions and Notes

Warning! Warnings indicate conditions, which if not observed, can cause personal injury!



Caution! Cautions are included to help you avoid damaging hardware or losing data. e.g.



There is a danger of a new battery exploding if it is incorrectly installed. Do not attempt to recharge, force open, or heat the battery. Replace the battery only with the same or equivalent type recommended by the manufacturer. Discard used batteries according to the manufacturer's instructions.

Note! Notes provide optional additional information.



Document Feedback

To assist us in making improvements to this manual, we would welcome comments and constructive criticism. Please send all such - in writing to: support@advan-tech.com

Safety Instructions

1. Read these safety instructions carefully.
2. Keep this User Manual for later reference.
3. Disconnect this equipment from any AC outlet before cleaning. Use a damp cloth. Do not use liquid or spray detergents for cleaning.
4. For plug-in equipment, the power outlet socket must be located near the equipment and must be easily accessible.
5. Keep this equipment away from humidity.
6. Put this equipment on a reliable surface during installation. Dropping it or letting it fall may cause damage.
7. The openings on the enclosure are for air convection. Protect the equipment from overheating. **DO NOT COVER THE OPENINGS.**
8. Make sure the voltage of the power source is correct before connecting the equipment to the power outlet.
9. Position the power cord so that people cannot step on it. Do not place anything over the power cord.
10. All cautions and warnings on the equipment should be noted.
11. If the equipment is not used for a long time, disconnect it from the power source to avoid damage by transient overvoltage.
12. Never pour any liquid into an opening. This may cause fire or electrical shock.
13. Never open the equipment. For safety reasons, the equipment should be opened only by qualified service personnel.
14. If one of the following situations arises, get the equipment checked by service personnel:
 - The power cord or plug is damaged.
 - Liquid has penetrated into the equipment.
 - The equipment has been exposed to moisture.
 - The equipment does not work well, or you cannot get it to work according to the user's manual.
 - The equipment has been dropped and damaged.
 - The equipment has obvious signs of breakage.
15. **DO NOT LEAVE THIS EQUIPMENT IN AN ENVIRONMENT WHERE THE STORAGE TEMPERATURE MAY GO BELOW -20° C (-4° F) OR ABOVE 60° C (140° F). THIS COULD DAMAGE THE EQUIPMENT. THE EQUIPMENT SHOULD BE IN A CONTROLLED ENVIRONMENT.**
16. **CAUTION: DANGER OF EXPLOSION IF BATTERY IS INCORRECTLY REPLACED. REPLACE ONLY WITH THE SAME OR EQUIVALENT TYPE RECOMMENDED BY THE MANUFACTURER, DISCARD USED BATTERIES ACCORDING TO THE MANUFACTURER'S INSTRUCTIONS.**

The sound pressure level at the operator's position according to IEC 704-1:1982 is no more than 70 dB (A).

DISCLAIMER: This set of instructions is given according to IEC 704-1. Advantech disclaims all responsibility for the accuracy of any statements contained herein.

Caution! *For power adapter selection: the information about the adapter output rating (12 Vdc, 5 A min, or 18 W min) is provided in the user manual for user's selection if the power adapter is not shipped with the unit*



Contents

Chapter 1	Overview	1
1.1	Introduction	2
1.2	Features	2
1.3	Applications.....	2
1.4	Product Photos.....	2
1.5	Naming Rule	3
Chapter 2	System Setup	5
2.1	Specifications	6
2.2	Dimensions	7
	Figure 2.1 IDS-3217 Series Dimensions	7
	Figure 2.2 IDS-3217E Series Dimensions	7
2.3	Rear Mount Assembly SOP	8
2.4	Cable Clamp	8
2.5	Packing List.....	9
Chapter 3	Touchscreen	11
3.1	OSD Functions (IDS-3217 Series)	12
3.1.1	OSD Main Menu: Push the MENU Key	12
3.1.2	Brightness Selection - Submenu.....	13
3.1.3	Contrast Control.....	13
3.1.4	Screen Settings - Submenu	13
3.1.5	Color Temperature - Submenu	14
3.1.6	Language - Submenu	14
3.1.7	OSD Setting - Submenu	15
3.1.8	VGA/DVI Selection.....	15
3.2	OSD Functions for IDS-3217E Series	16
3.2.1	OSD Main Menu: Push the MENU Key	16
3.2.2	OSD Lock.....	16
3.2.3	OSD Unlock	16
3.2.4	Color Adjustment - Submenu (Brightness /Contrast/ Color Adjust/Color temp/Auto Color).....	17
3.2.5	Image Setting Adjustment.....	17
3.2.6	Image Adjustment - Submenu (Clock/Phase/H. Position/V. Position)	18
3.2.7	OSD Menu Adjustment	18
3.2.8	OSD Adjustment - Submenu (OSD H.Pos./ OSD V.Pos./OSD Timer).....	19
3.2.9	OSD Adjustment - Language Submenu.....	19
3.2.10	Reset Adjustment.....	20
3.3	Touch Drivers.....	20
Appendix A	Troubleshooting	21
A.1	Introduction	22
A.2	Troubleshooting	22

Chapter 1

Overview

Sections include:

- Introduction
- Features
- Applications
- Product Photos
- Naming Rule

1.1 Introduction

The Advantech IDS-3217 series is a brand new Industrial IDS-3217 Monitor, designed to meet the needs of customers who want quick and easy integration with Advantech Embedded Box Computers, such as the ARK and DSA lines. Advantech offers two different versions of IDS-3217 to meet different demands: IDS-3217 series (superior grade version) and IDS-3217E series (Economy version)

1.2 Features

- 17" SXGA LED backlight panel provides 20~30% power saving
- -20 °C ~ +60 °C wide operating temperature support
- Specially designed 5-wire resistive touchscreen
- All new mechanical design with integrated bracket for easy installation
- Versatile mounting methods for rear mount and VESA mount (75 x 75 mm, 100 x 100 mm)

1.3 Applications

Application scenarios - self-service applications:

- Kiosk / POI machine
- Transportation machine
- Ticketing machine
- Financial ATM
- Entertainment / Gaming / Slot machine
- HMI (Human-Machine Interface) equipment controller monitor
- Public communication machine
- Public advertisement machine

1.4 Product Photos

Front view



Rear view

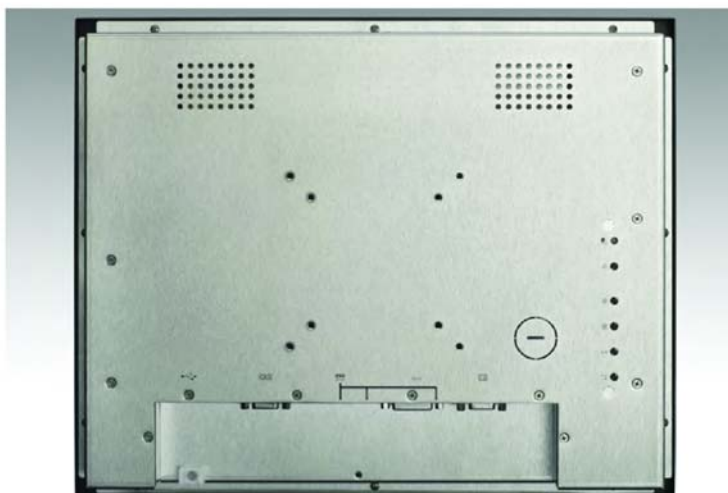

IDS-3217 Bottom View



IDS-3217E Bottom View



1.5 Naming Rule

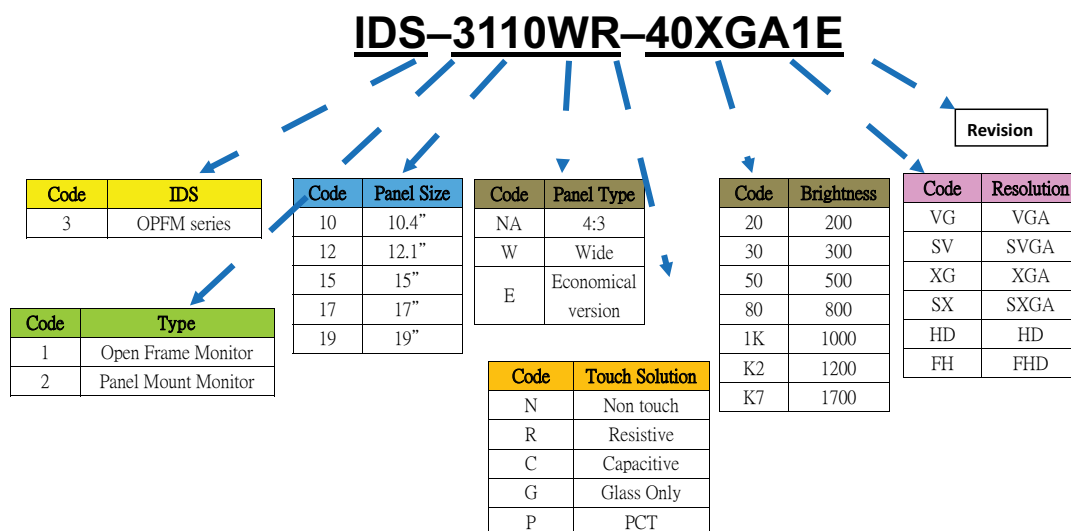

Chapter 2

System Setup

Sections include:

- Specifications
- Dimensions
- Rear Mount Assembly SOP
- Cable Clamp
- Accessory Packing

2.1 Specifications

Note! The IDS-3217 series offers the following features and meets precise specifications.



Unless otherwise noted, all the information listed below is subject to change without prior notification.

Model	IDS-3217	IDS-3217E	
Display	Size	17" LED panel	17" LED panel
	Resolution	1280 x 1024 (SXGA)	1280 x 1024 (SXGA)
	Viewing Angle	85° /85° (H), 80° /80° (V)	85° /85° (H), 80° /80° (V)
	Brightness	350 (cd/m ²)	250 (cd/m ²)
	Color Support	16.7 M colors	16.7 M colors
	Contrast Ratio	800:1	1000:1
	Response Time	30 [msec]	5 [msec]
	Backlight Life	50,000 hrs	40,000 hrs
Touch	T/S Type	5-Wire Resistive Touch Screen	
	Surface Hardness	3H	
	Durability	10 million touches	
	Transparency	80% ± 3%	
Environment	Operating Temperature	-20 ~ 60° C (-4 ~ 140° F)	0~ 45° C (32 ~ 113° F)
	Storage Temperature	-30 ~ 70° C (-22 ~ 158° F)	-20 ~ 60° C (-4 ~ 140° F)
	Humidity	10 ~ 90% @ 40° C, non-condensing	
	Vibration	5-500Hz, 0.026G ² /Hz, 2.16Grms, X, Y, Z 1 hour per axis	
System	I/O (IDS-3217)	VGA x 1; DVI-D x 1; 12 VDC Jack x 1; USB x1; RS-232 x 1 (USB & RS-232 are reserved for the connection to enable touch usage only)	
	I/O (IDS-3217E)	VGA x 1; 12 VDC Jack x 1; USB x1; RS-232 x 1 (USB & RS-232 are reserved for the connection to enable touch usage only)	
	OSD (IDS-3217)	Keys: Menu, Up, Down, Auto Adjust, Monitor Power on/off. Menu Functions: Brightness, Contrast, Screen Settings, Color Temp, Language OSD Settings, VGA/DVI, Recall, Auto Adjust.	
	OSD (IDS-3217E)	Keys: Menu, Up, Down, Auto Adjust, Monitor Power on/off. Menu Functions: Brightness, Contrast, Color Adjust, Color Temp, Auto Color and Language.	
	Power	60 W power adapter, with AC 100 ~ 240 V input and DC +12 V @ 5 A output.	
	EMC Compliance	CE/FCC/CCC	

2.2 Dimensions

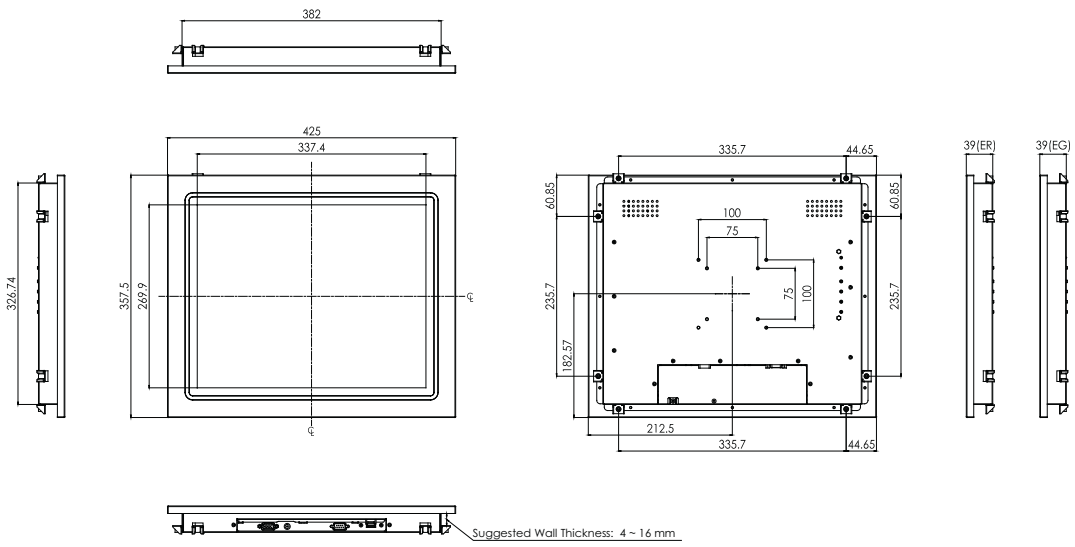
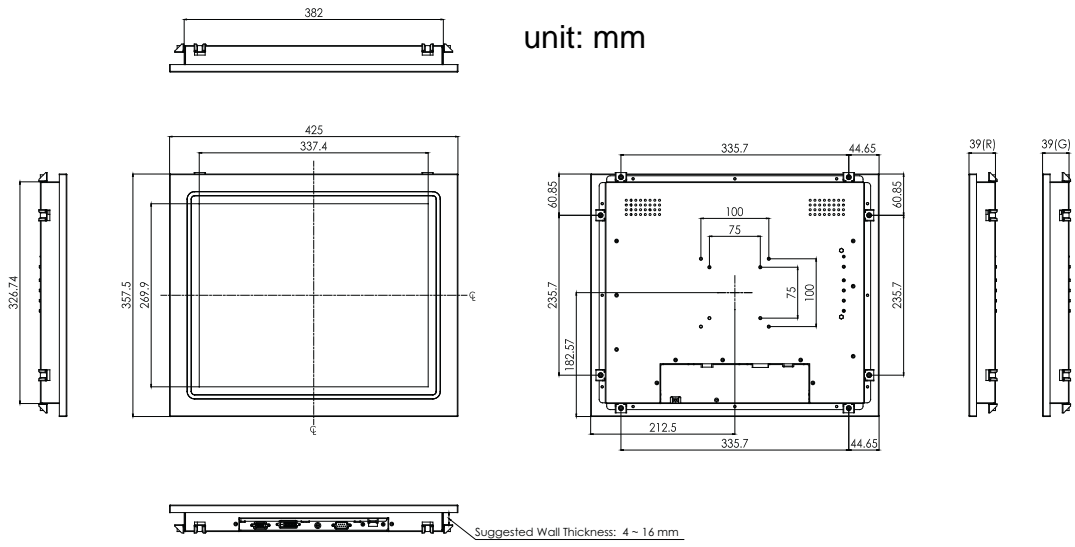

2.3 Rear Mount Assembly SOP

1. Use the M3 screws to attach and tighten as follows.

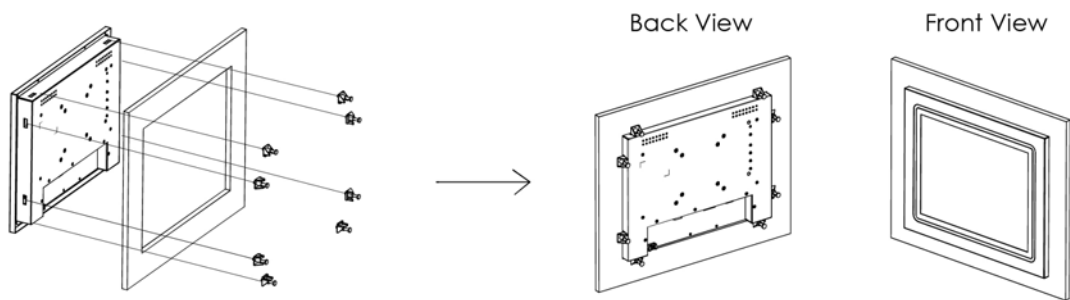

2.4 Cable Clamp

1. A cable clamp also comes with Panel Mount Monitor to fix the power cable, see below.

Cable Clamp with IDS-3217

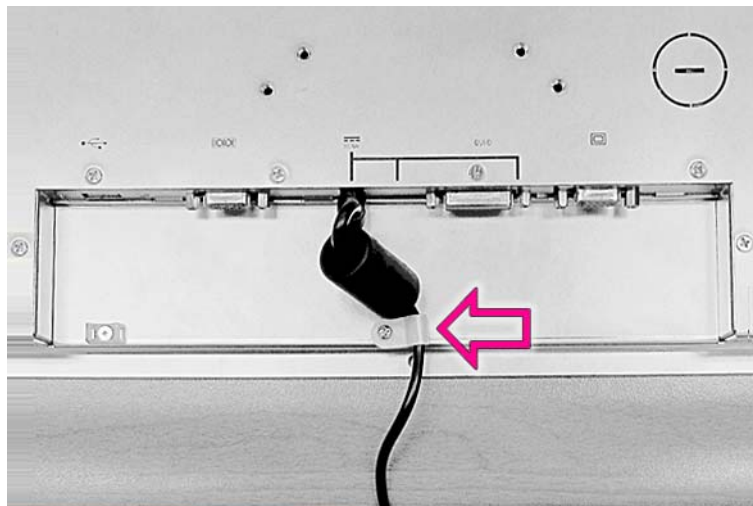

Cable Clamp with IDS-3217E

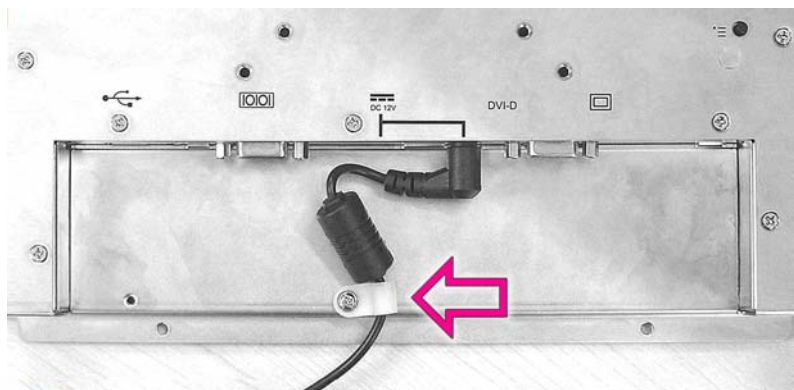

2. A cable tie for the USB cable is included in the accessory box, see below:

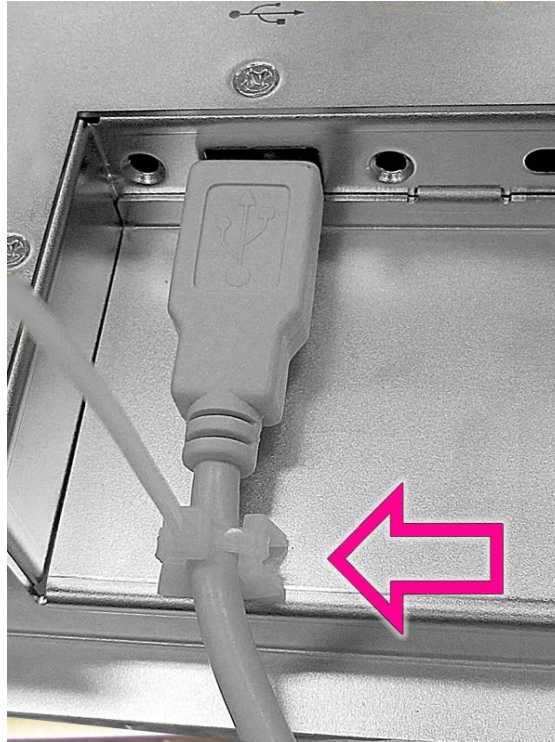

2.5 Packing List

- 1 x VGA cable 15P(M) 1.8 meter
- 1 x USB-A(M)/USB-A(M) 1.8 meter
- 8 x panel-mount clamps
- 8 x Panel-mount clamping screws: M4_25L
- 1 x cable clamp
- 1 x cable clamp screw
- 1 x cable tie
- 1 x 60 W DC12V Power Adapter (optional order)
- 1 x Power Cord (optional order)
- 1 x DVI cable 2.0 meter (optional order)
- 1 x RS-232 9P/9P 1.8M M/F cable (optional order)

Note! *The above accessory cables are subject to change in different SKUs.*



Chapter 3

Touchscreen

Sections include:

- OSD Functions
- Touch Drivers

3.1 OSD Functions (IDS-3217 Series)

The OSD of the IDS-3217 display (1280 x 1024 resolution) was selected to illustrate examples below:

Buttons	Description
Power	Turn the monitor power ON or OFF
Menu	Activate the OSD menu Exit menu
Auto	Automatically adjust the clock, phase H-position and V-position
Value Up/Down	Move the selector to the previous option Decrease the gauge value of the selected option

LED Functions	
DPMS ON	Green
DPMS STANDBY	Orange
DPMS OFF	Red

3.1.1 OSD Main Menu: Push the MENU Key



3.1.2 Brightness Selection - Submenu



3.1.3 Contrast Control

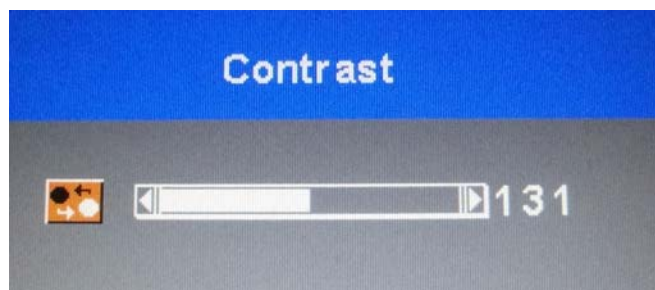

3.1.4 Screen Settings - Submenu

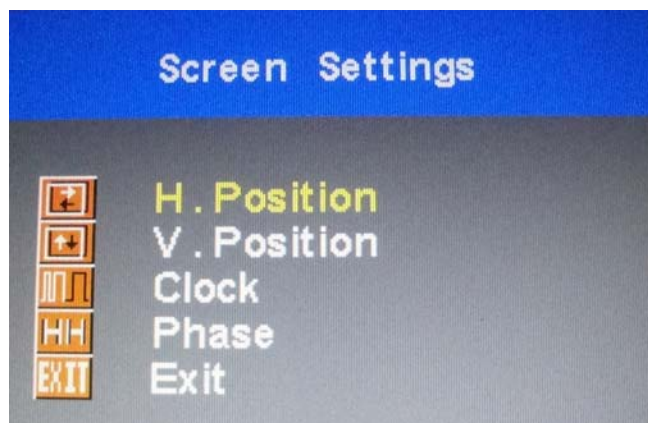

3.1.5 Color Temperature - Submenu



3.1.6 Language - Submenu



3.1.7 OSD Setting - Submenu

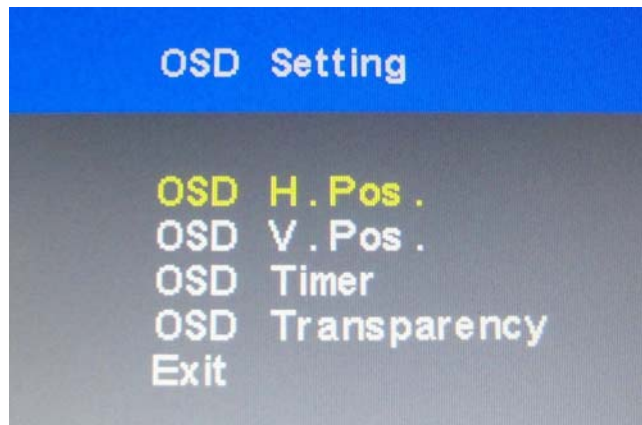

3.1.8 VGA/DVI Selection

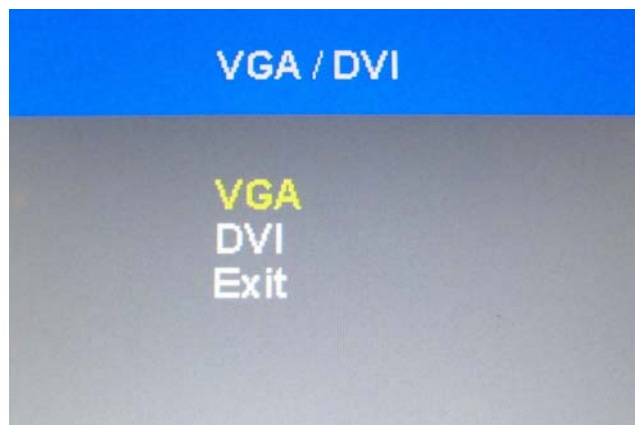

3.2 OSD Functions for IDS-3217E Series

3.2.1 OSD Main Menu: Push the MENU Key

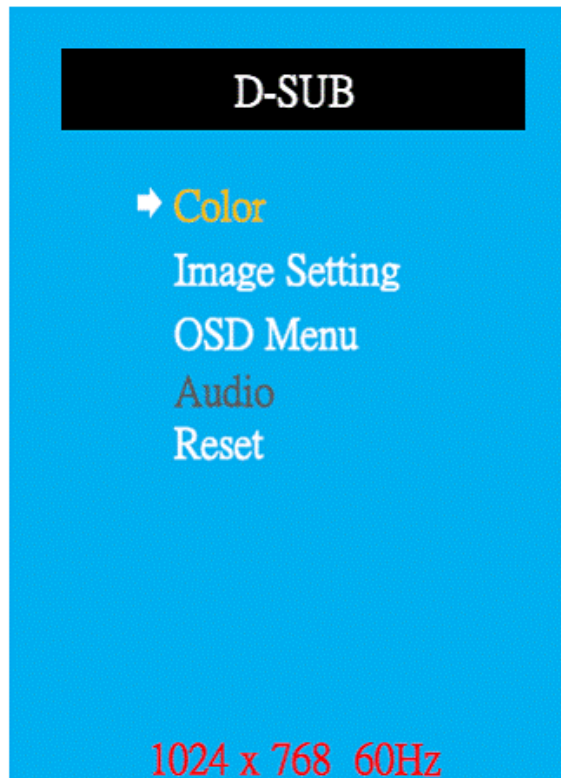

3.2.2 OSD Lock

Press the "Right" key and "Menu" key simultaneously to lock the OSD key.



3.2.3 OSD Unlock

Press the "Right" key and "Menu" key simultaneously again to unlock the OSD key.



3.2.4 Color Adjustment - Submenu (Brightness /Contrast/ Color Adjust/Color temp/Auto Color)

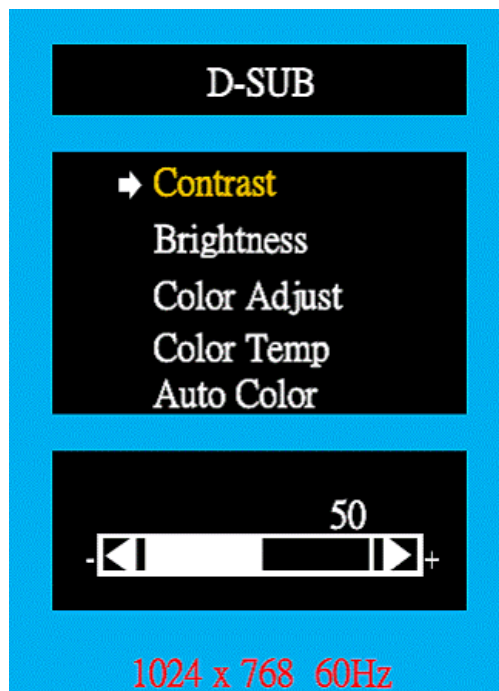

3.2.5 Image Setting Adjustment

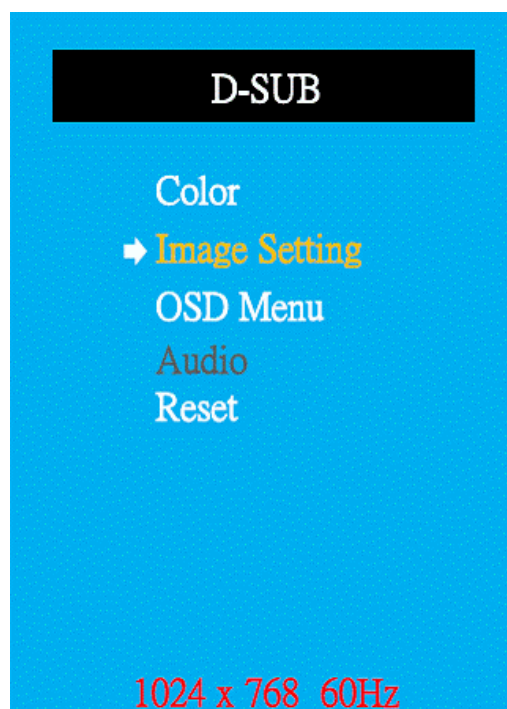

3.2.6 Image Adjustment - Submenu (Clock/Phase/H. Position/V. Position)

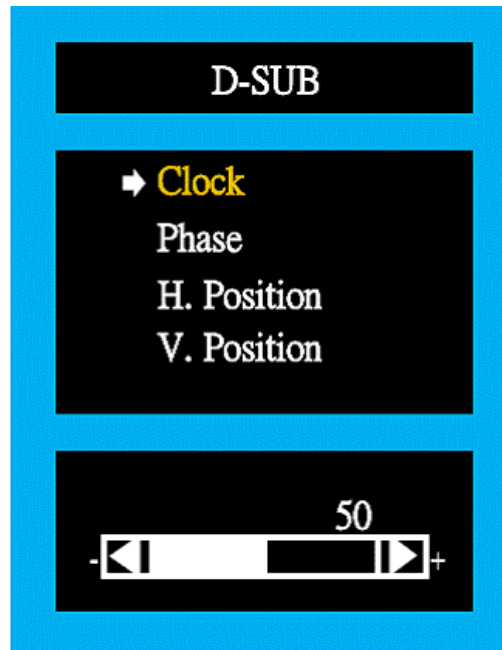

3.2.7 OSD Menu Adjustment

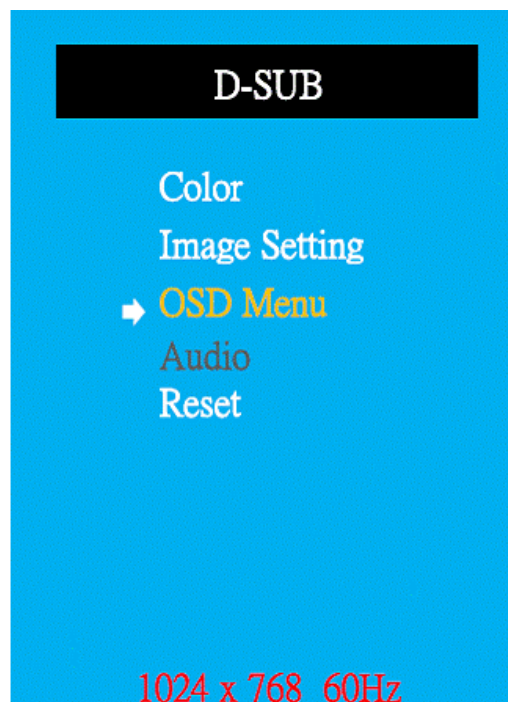

3.2.8 OSD Adjustment - Submenu (OSD H.Pos./ OSD V.Pos./OSD Timer)

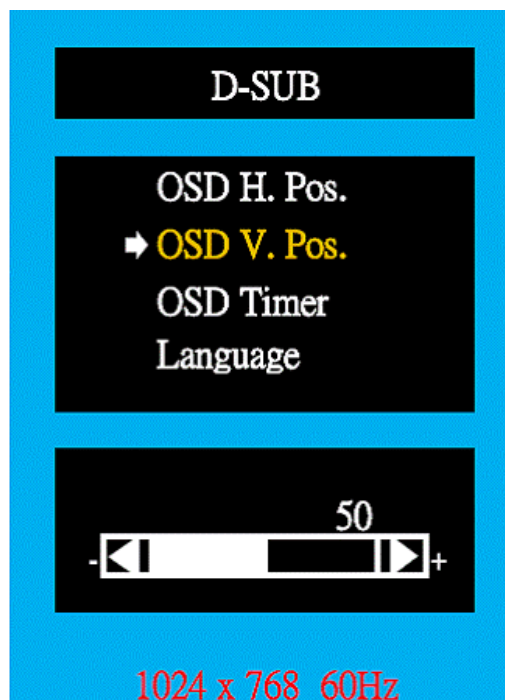

3.2.9 OSD Adjustment - Language Submenu



3.2.10 Reset Adjustment

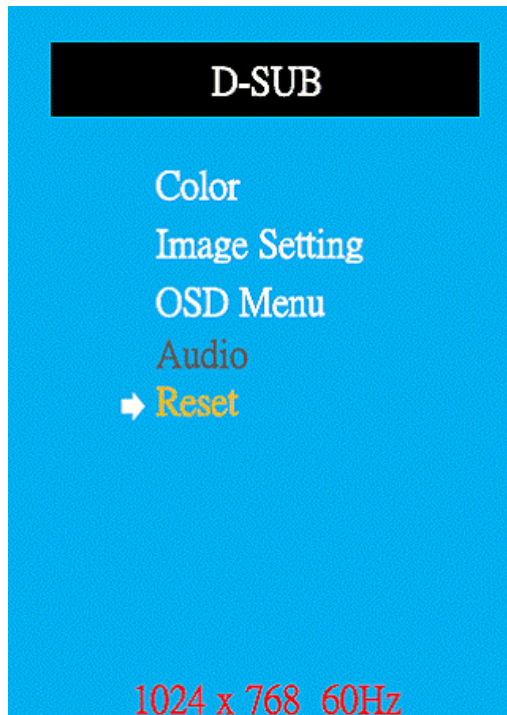

3.3 Touch Drivers

The T/S driver CD-ROM is in the accessory box and comes with the product. It is also available online at the Advantech website as follows:

<http://support.advantech.com/support/default.aspx>

Appendix **A**

Troubleshooting

A.1 Introduction

If experiencing trouble with the monitor, or it fails to operate correctly, please refer to the following instructions before calling the Advantech service center. If unable to correct the faults using the instructions below, then please contact the distributor or the services/repair center.

A.2 Troubleshooting

No image appears on screen

- Check to see that all the I/O and power connectors are installed correctly and connected. (Refer to 1.4, Product Photos, Bottom View)
- Make sure that none of the connectors is crooked, broken or loose.
- Make sure that the OSD power on the LED is turned on.
- Make sure that the brightness is not set to minimum.
- Make sure that the screen resolution is set to the correct setting for the type of LCD, and that the setting does not exceed the resolution specified for the particular model of LCD.

The image is incorrectly displayed, or the full screen image does not appear

- Please make sure the screen resolution on the motherboard is correct.

The position of screen is not in the center

- Adjust the H-position and V-position, or perform "Auto".

Out of range

- When the message "Out of Range" appears onscreen, it indicates that the signal of the computer is not compatible with the LCD display; i.e. the resolution exceeds the specified resolution for the LCD.
- Adjust the BIOS setting to match computer output to the correct LCD resolution.

No signal

- The display is powered on, but can neither receive or display any signal from the computer. Check all power switches, power cables and VGA signal cables to ensure that all are connected correctly on both ends.

Going to sleep

- If the system goes to sleep, then the display has either been set to power-saving mode, or the display is experiencing a sudden signal disconnection problem. Check the BIOS system settings, and/or Windows configuration. Then check the connection of the power cable to computer on both ends.

ADVANTECH

Enabling an Intelligent Planet

www.advantech.com

Please verify specifications before quoting. This guide is intended for reference purposes only.

All product specifications are subject to change without notice.

No part of this publication may be reproduced in any form or by any means, electronic, photocopying, recording or otherwise, without prior written permission of the publisher.

All brand and product names are trademarks or registered trademarks of their respective companies.

© Advantech Co., Ltd. 2015