

PART  
NAME

3 BUTTON GRABBER

PART  
No.

HH - 3503

REV.  
DATE

10-29-08

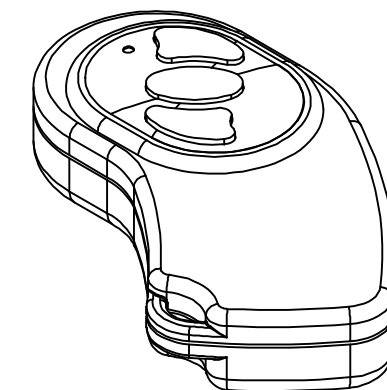
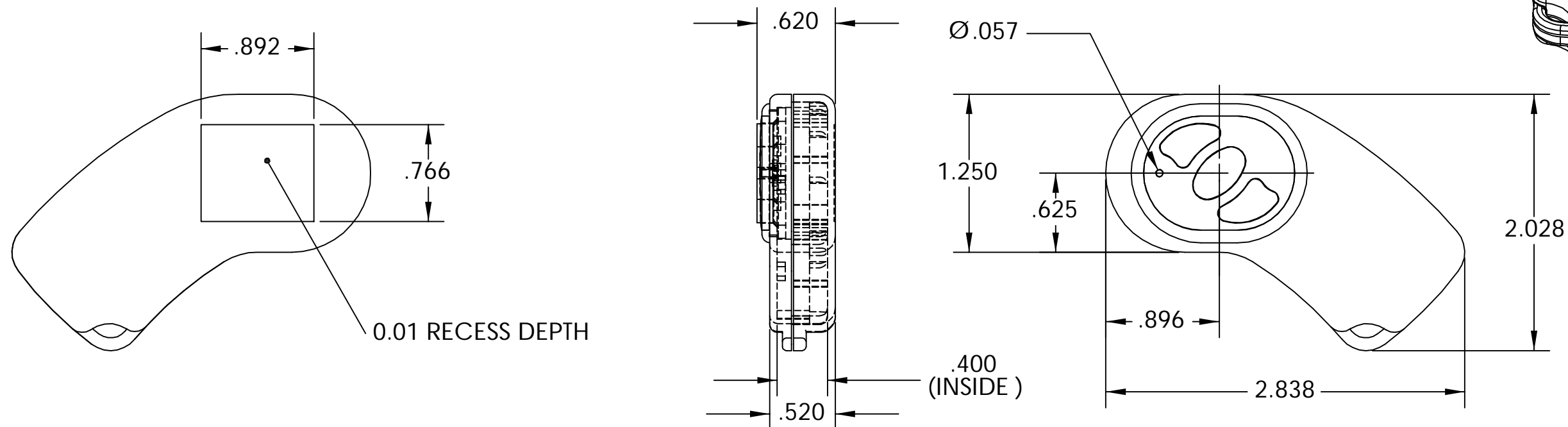

NOTES:

1. ALL DIMENSIONS ARE IN INCHES
2. MATERIAL: BODY & COVER - ABS (UL94-HB)  
BUTTON - SILICONE RUBBER
3. FINISH: BODY & COVER - TEXTURED  
BUTTON - SMOOTH
4. COLOR: BODY & COVER - BLACK  
BUTTON - GRAY
5. PCB IS NOT INCLUDED. TO BE SUPPLIED BY CUSTOMER
6. SUGGESTED BATTERY TYPE: 20 MM COIN CELL TYPE

