

PMC Panel Mount Power Supply

12 V 150 W 1 Phase / PMC-12V150W1B□

PMC

Highlights & Features

- Universal AC input range from 85 Vac to 264 Vac without power de-rating
- Full Aluminum casing for light weight and corrosion resistant handling
- High MTBF > 700,000 hrs. as per Telcordia SR-332
- Overvoltage / Overcurrent / Over Temperature Protections
- IP 20 Compliant (for PMC-12V150W1BJ)
- Certified according to IEC/EN/UL 62368-1

Safety Standards



CB Certified for worldwide use

Model Number:	PMC-12V150W1B□
Unit Weight:	0.54 kg (1.19 lb)
Dimensions (L x W x H):	178 x 97 x 38 mm (7.01 x 3.82 x 1.50 inch)



General Description

Delta's PMC series of panel mount power supply offers a nominal output voltage of 12 V, a wide temperature range from -10°C to +70°C and a highly dependable minimum hold-up time. The state-of-the-art design is made to withstand harsh industrial environments. What makes the product stand out from the crowd is its lightweight full aluminum body design, which can withstand shock and vibration according to IEC60068-2. The PMC series also offers overvoltage and overload protection. Using a wide input voltage range design, it is compatible worldwide. The input also includes DC operating voltage from 125-375 Vdc. Best of all, this excellent design and quality does not come with a big price tag.

Model Information

PMC Panel Mount Power Supply

Model Number	Input Voltage Range	Rated Output Voltage	Rated Output Current
PMC-12V150W1B□	85-264 Vac (125-375 Vdc)	12 Vdc	12.50 A

Model Numbering

PMC	12V	150W	1	B	□
PMC Series	Output Voltage	Output Power	Single Phase	With PFC	Connector Type A – Terminal Block J – IP20 Connector* L – Front Face*

*Options



PMC Panel Mount Power Supply

12 V 150 W 1 Phase / PMC-12V150W1B□

Specifications

Input Ratings / Characteristics

Nominal Input Voltage	100-240 Vac	
Input Voltage Range	85-264 Vac	
Nominal Input Frequency	50-60 Hz	
Input Frequency Range	47-63 Hz	
Nominal DC Input Voltage	125-250 Vdc	
DC Input Voltage Range*	125-375 Vdc	
Input Current	< 1.7 A @ 115 Vac, < 1.0 A @ 230 Vac	
Efficiency at 100% Load	> 87% @ 115 Vac, > 88% @ 230 Vac	
Max Power Dissipation	0% load	< 1.00W @ 115Vac, < 0.5W @ 230Vac
	100% load	< 22.4W @ 115Vac, < 20.4W @ 230Vac
Max Inrush Current	< 60 A @ 115 Vac, < 120 A @ 230 Vac	
Power Factor	> 0.99 @ 115 Vac, > 0.90 @ 230 Vac	
Leakage Current	< 1 mA @ 240 Vac	

*Fulfills test conditions for DC input. Safety approval for DC input can be obtained upon request.

Output Ratings / Characteristics**

Nominal Output Voltage	12 Vdc
Factory Set Point Tolerance	12 Vdc \pm 2%
Output Voltage Adjustment Range	11-14 Vdc
Output Current	12.50 A (150 W max.)
Output Power	150 W
Line Regulation	< 0.5% (@ 85-264 Vac input, 100% load)
Load Regulation	< 1.0% (@ 85-264 Vac input, 0-100% load)
PARD*** (20MHz)	< 100 mVpp
Rise Time	< 30 ms @ nominal input (100% load)
Start-up Time	< 2000 ms @ nominal input (100% load)
Hold-up Time	> 30 ms @ 115 Vac & 230 Vac (100% load)
Dynamic Response (Overshoot & Undershoot O/P Voltage)	\pm 5% @ 85-264Vac input, 0-100% load (Slew Rate: 0.1A/ μ s, 50% duty cycle @ 5Hz)
Start-up with Capacitive Loads	8,000 μ F Max

**For power de-rating from 50°C to 70°C, see power de-rating on page 3.

***PARD is measured with an AC coupling mode, 5cm wires, and in parallel with 0.1 μ F ceramic capacitor.

PMC Panel Mount Power Supply

12 V 150 W 1 Phase / PMC-12V150W1B□

Mechanical

Case Cover	Aluminium	
Dimensions (L x W x H)	178 x 97 x 38 mm (7.01 x 3.82 x 1.50 inch)	
Unit Weight	0.54 kg (1.19 lb)	
Indicator	Green LED	DC OK
Cooling System	Convection	
Terminal	PMC-12V150W1BA	M3.5 x 7 Pins (Rated 300 V/15 A)
	PMC-12V150W1BJ	M3.5 x 7 Pins (Rated 300 V/20 A)
	PMC-12V150W1BL	M3.5 x 7 Pins (Rated 300 V/20 A)
Wire	PMC-12V150W1BA	AWG 18-14
	PMC-12V150W1BJ	AWG 18-12
	PMC-12V150W1BL	AWG 18-14
Noise	Sound Pressure Level (SPL) <40 dBA	

Environment

Surrounding Air Temperature	Operating	-10°C to +70°C
	Storage	-25°C to +85°C
Power De-rating	> 50°C de-rate power by 2.5% / °C	
Operating Humidity	5 to 95% RH (Non-Condensing)	
Operating Altitude	0 to 5,000 Meters (16,400 ft.)	
Shock Test	Non-Operating	IEC60068-2-27, 30 G (300 m/S ²) for a duration of 18ms 1 times per direction, 6 times in total
Vibration	Non-Operating	IEC60068-2-6, 10 Hz to 500 Hz @ 30 m/S ² (3G peak); 60 min per axis for all X, Y, Z direction
Over Voltage Category	II	
Pollution Degree	2	

Protections

Overvoltage	16V +10%/-5%, SELV output, Hiccup Mode, Non-Latching (Auto-Recovery).
Overload / Overcurrent	> 115% of rated load current, Hiccup Mode, Non-Latching (Auto-Recovery).
Over Temperature	< 75°C Ambient Temp@ 100% load, Non-Latching (Auto-Recovery).
Short Circuit	Hiccup Mode, Non-Latching (Auto-Recovery when the fault is removed).
Internal Fuse at L pin	T4AH
Protection Against Shock	Class I with PE* connection

*PE: Primary Earth

Reliability Data

MTBF	> 700,000 hrs. as per Telcordia SR-332 I/P: 115Vac & 230Vac, O/P: 100% load, Ta: 25°C
Expected Cap Life Time	10 years (115 Vac & 230 Vac, 50% load @ 40°C)

PMC Panel Mount Power Supply

12 V 150 W 1 Phase / PMC-12V150W1B□

Safety Standards / Directives

Safety Entry Low Voltage		SELV (IEC 60950-1)
Electrical Safety	SIQ Bauart	EN 62368-1
	UL/cUL recognized	UL 60950-1 and CSA C22.2 No. 60950-1 (File No. E191395) UL 62368-1 and CSA C22.2 No. 62368-1 (File No. E191395)
	CB scheme	IEC 60950-1, IEC 62368-1
	KC	K 60950-1
	BIS	IEC 60950-1
	UKCA	BS EN 62368-1
CCC		GB9254, GB17625.1 and GB4943.1
BIS		IS 13252 (Part 1)
CE		In conformance with EMC Directive 2014/30/EU and Low Voltage Directive 2014/35/EU
UKCA		In conformance with Electrical Equipment (Safety) Regulations 2016 No. 1011 and The Electromagnetic Compatibility Regulations 2016 No. 1091
Galvanic Isolation	Input to Output	3.0 kVac
	Input to Ground	1.5 kVac
	Output to Ground	0.5 kVac

EMC

Emissions (CE & RE)		CISPR32, EN/BS EN 55032, KN 32 FCC Title 47: Class B, GB9254	
Immunity		Generic Standards: EN/BS EN 55024, KN 35	
Electrostatic Discharge	IEC61000-4-2	Level 4 Criteria A ¹⁾ Air Discharge: 15 kV Contact Discharge: 8 kV	
Radiated Field	IEC61000-4-3	Level 3 Criteria A ¹⁾ 80 MHz-1 GHz, 10 V/M with 1kHz tone / 80% modulation	
Electrical Fast Transient / Burst	IEC61000-4-4	Level 3 Criteria A ¹⁾ 2 kV	
Surge	IEC61000-4-5	Level 3 Criteria A ¹⁾ Common Mode ²⁾ : 2 kV Differential Mode ³⁾ : 1 kV	
Conducted	IEC61000-4-6	Level 3 Criteria A ¹⁾ 150 kHz-80 MHz, 10 Vrms	
Power Frequency Magnetic Fields	IEC61000-4-8	Criteria A ¹⁾ 10 A/Meter	
Voltage Dips and Interruptions	IEC61000-4-11	100% dip; 1 cycle (20 ms); Self Recoverable	
Low Energy Pulse Test (Ring Wave)	IEC61000-4-12	Level 3 Criteria A ¹⁾ Common Mode ²⁾ : 2 kV Differential Mode ³⁾ : 1 kV	
Harmonic Current Emission		IEC/EN/BS EN 61000-3-2, Class A; GB17625.1	
Voltage Fluctuation and Flicker		IEC/EN/BS EN 61000-3-3	
Voltage Sag Immunity SEMI F47 – 0706	80% of 200 Vac 70% of 200 Vac 50% of 200 Vac	160 Vac, 1000 ms 140 Vac, 500 ms 100 Vac, 200 ms	Criteria A ¹⁾ Criteria A ¹⁾ Criteria A ¹⁾

1) Criteria A: Normal performance within the specification limits

2) Asymmetrical: Common mode (Line to earth)

3) Symmetrical: Differential mode (Line to line)

PMC Panel Mount Power Supply

12 V 150 W 1 Phase / PMC-12V150W1B□

Block Diagram

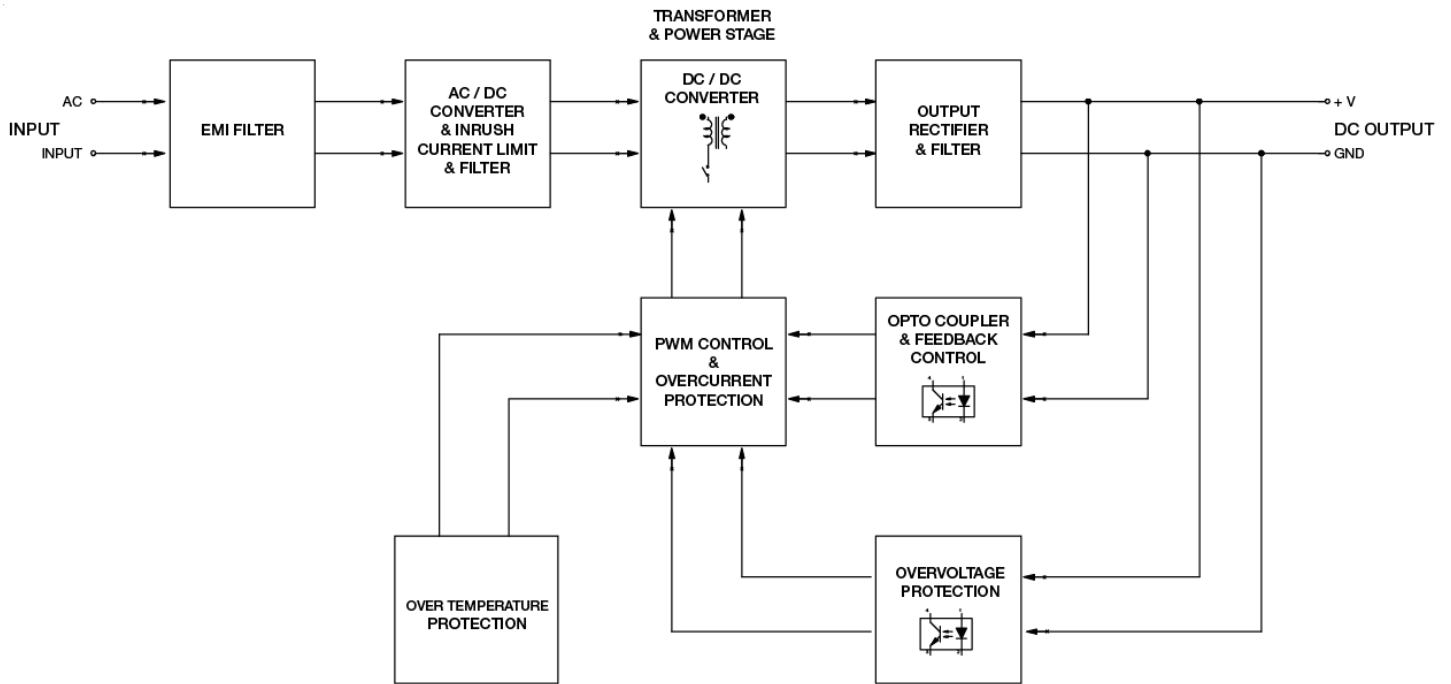

Device Description

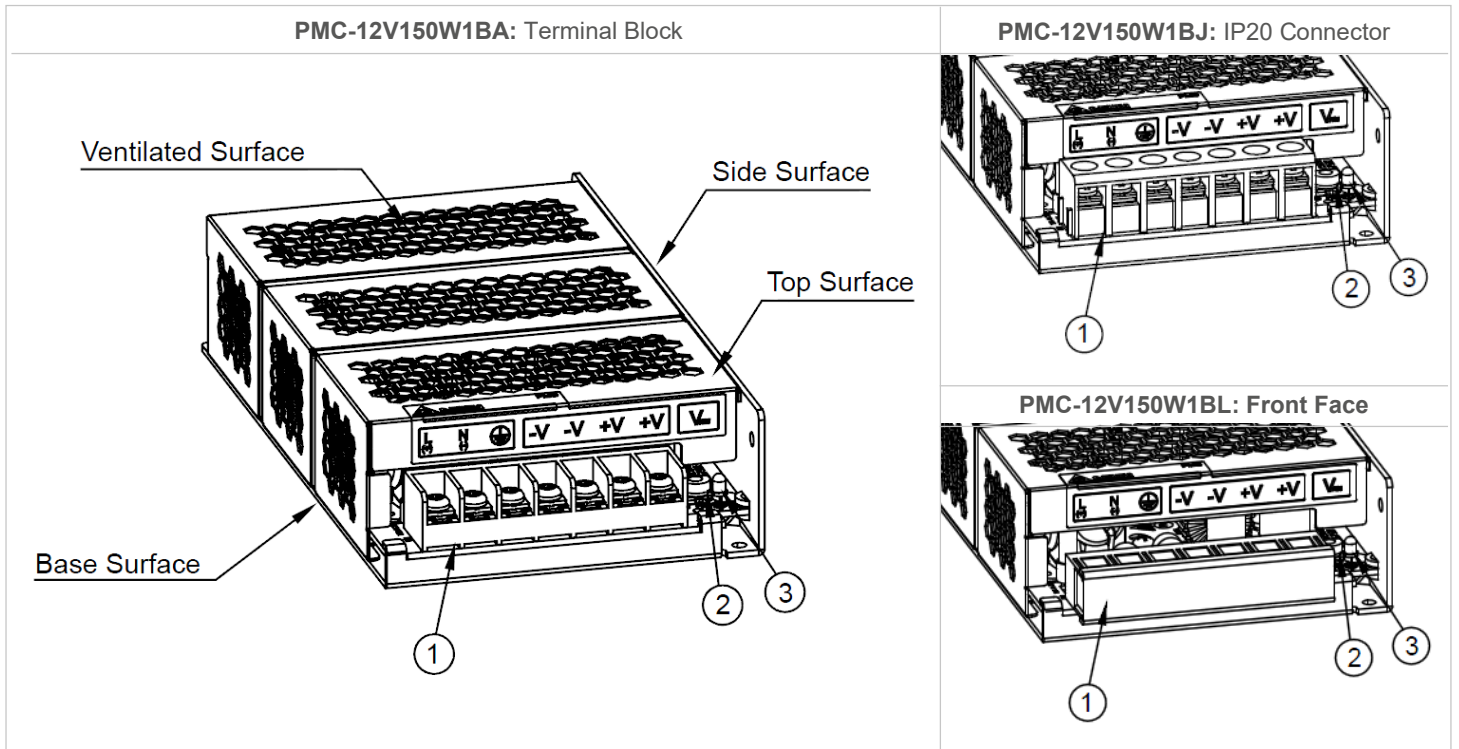

- 1) Input & Output terminal block connector
- 2) DC Voltage adjustment potentiometer
- 3) DC OK control LED (Green)

PMC Panel Mount Power Supply

12 V 150 W 1 Phase / PMC-12V150W1B□

Dimensions

- **PMC-12V150W1BA:** Terminal Block
L x W x H: 178 x 97 x 38 mm (7.01 x 3.82 x 1.50 inch)

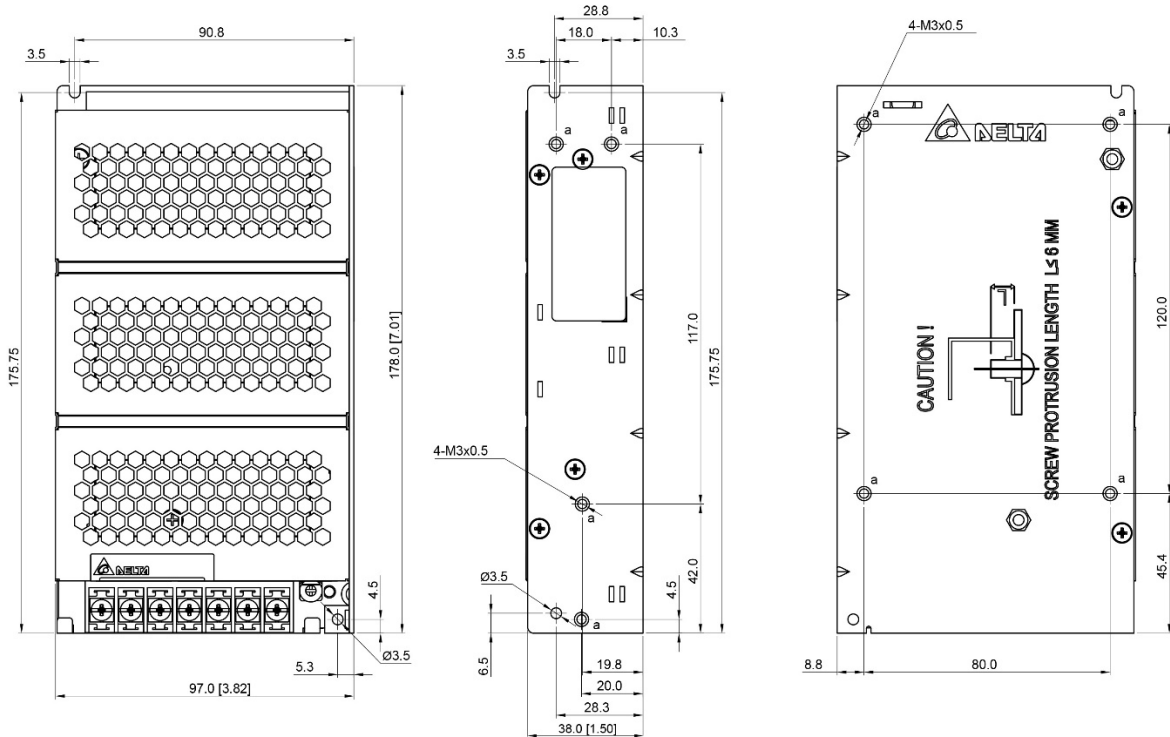

- **PMC-12V150W1BJ:** IP20 Connector
L x W x H: 178 x 97 x 38 mm (7.01 x 3.82 x 1.50 inch)

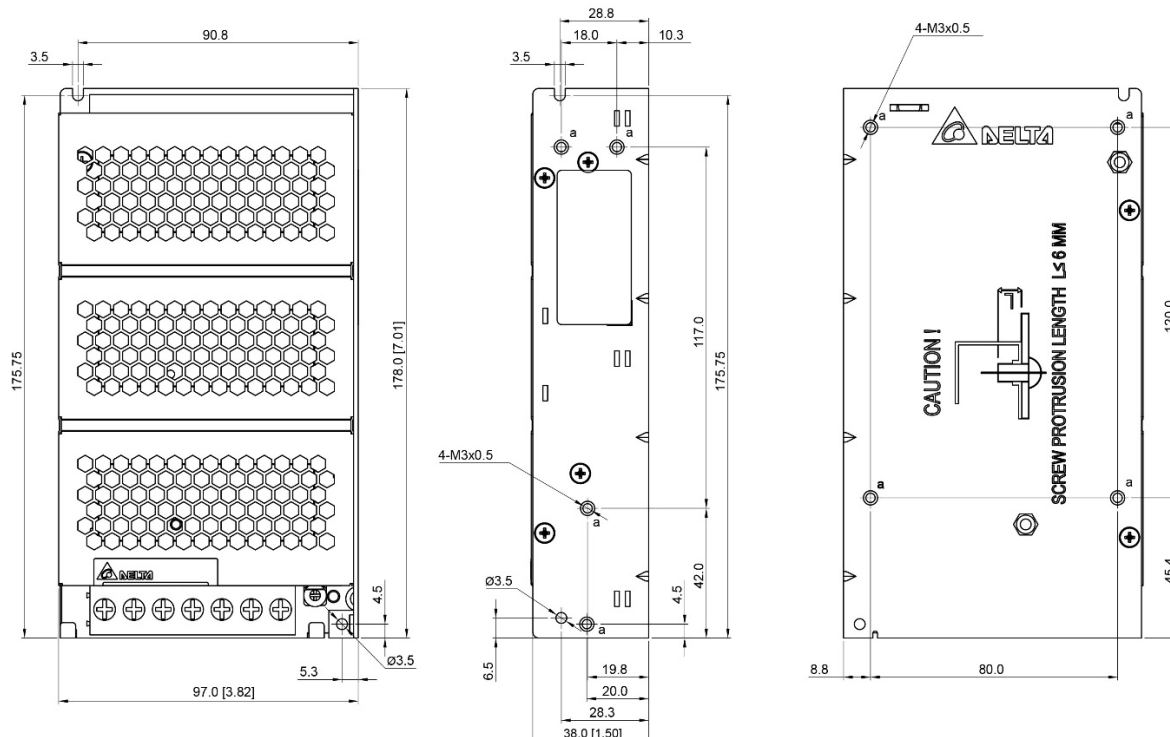

PMC Panel Mount Power Supply

12 V 150 W 1 Phase / PMC-12V150W1B□

- **PMC-12V150W1BL**: Front Face
L x W x H: 178 x 97 x 38 mm (7.01 x 3.82 x 1.50 inch)

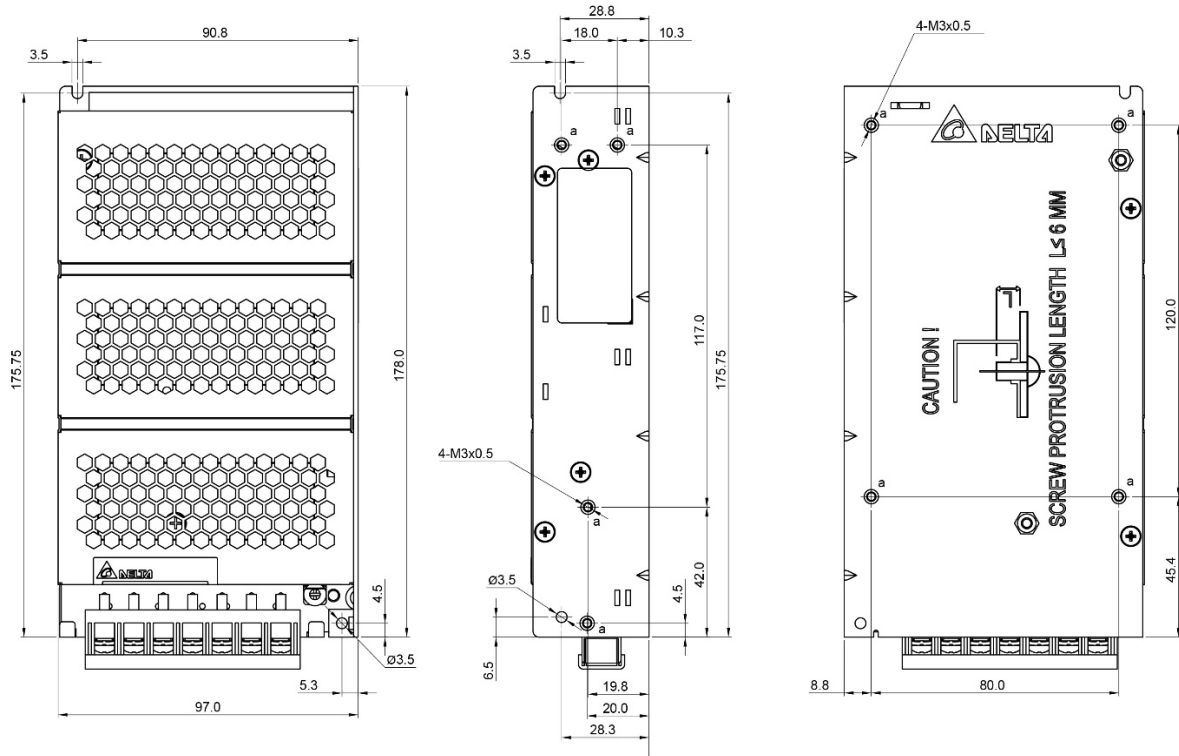

Engineering Data

Output Load De-rating VS Surrounding Air Temperature

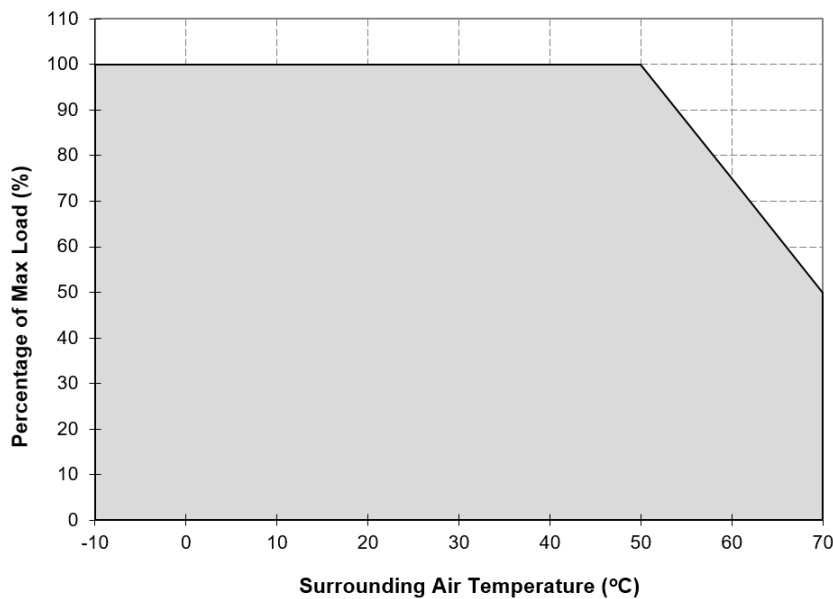

Fig. 1 De-rating for Vertical and Horizontal Mounting Orientation
> 50°C de-rate power by 2.5% / °C

Note

1. Power supply components may degrade, or be damaged, when the power supply is continuously used outside the shaded region, refer to the graph shown in Fig. 1.
2. If the output capacity is not reduced when the surrounding air temperature exceeds its specification as defined on Page 3 under "Environment", the device may run into Over Temperature Protection. When activated, the output voltage will go into bouncing mode and will recover when the surrounding air temperature is lowered or the load is reduced as far as necessary to keep the device in working condition.
3. In order for the device to function in the manner intended, it is also necessary to keep a safety distance as recommended in the safety instructions while the device is in operation.
4. Depending on the surrounding air temperature and output load delivered by the power supply, the device housing can be very hot!
5. If the device has to be mounted in any other orientation, please contact info@deltapsu.com for more details.

PMC Panel Mount Power Supply

12 V 150 W 1 Phase / PMC-12V150W1B□

Output De-rating VS. Input Voltage

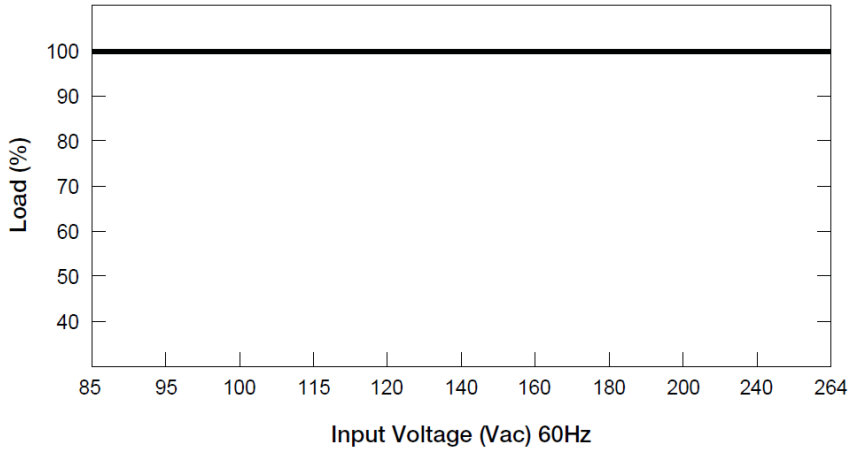

- No output power de-rating across the entire input voltage range

Assembly & Installation

Mounting

- Ⓐ Mounting holes for power supply assembly onto the mounting surface. The power supply shall be mounted on minimum 2 mounting holes using M3 screw minimum 5 mm (0.20 inch) length.
- Ⓑ This surface belongs to customer's end system or panel where the power supply is mounted.
- Ⓒ Connector

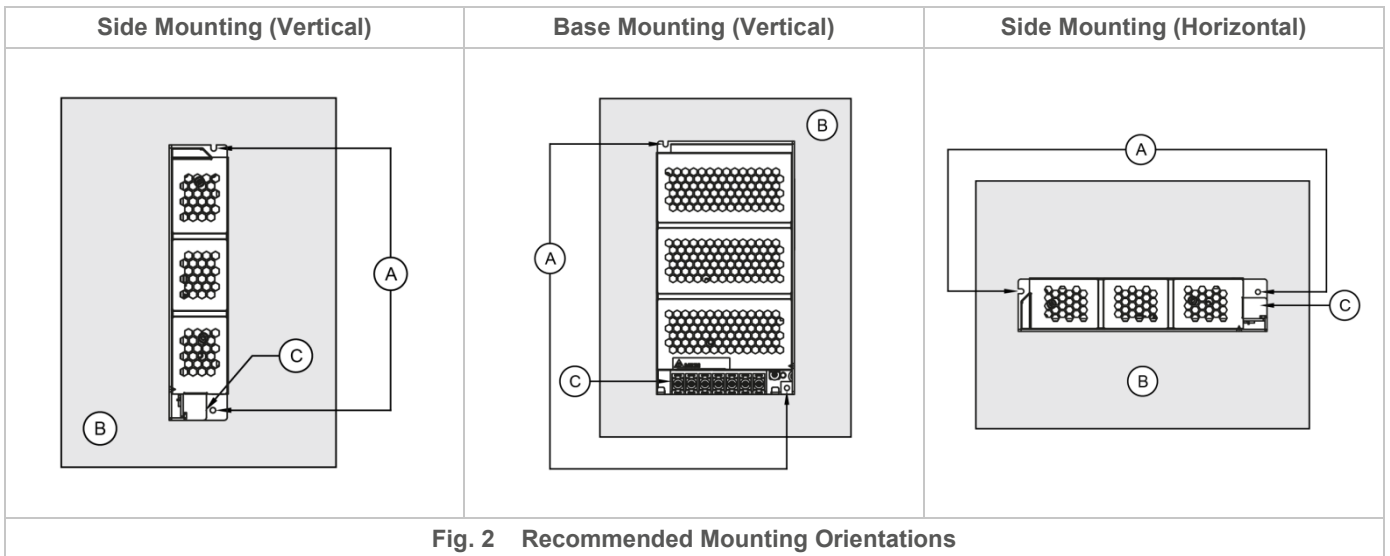

- Use flexible cable (stranded or solid) with the following sizes:

PMC-12V150W1BA	PMC-12V150W1BJ	PMC-12V150W1BL
AWG 18-14	AWG 18-12	AWG 18-14

- The torque at the Connector shall not exceed 13 Kgf.cm (11.23 lb.in). The insulation stripping length should not exceed 0.275" or 7mm.

PMC Panel Mount Power Supply

12 V 150 W 1 Phase / PMC-12V150W1B□

Installation

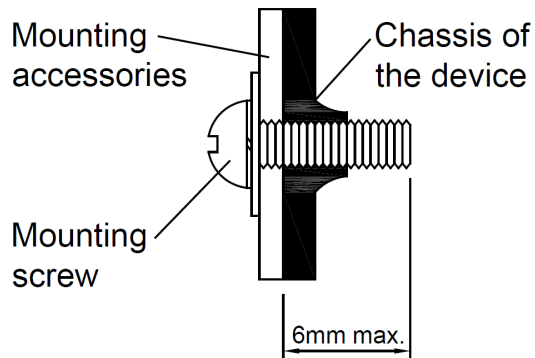

- Only use M3 screw ≤ 6 mm (0.23 inch) through the base mounting holes. This is to keep a safe distance between the screw and internal components.
- Recommended mounting tightening torque: 4~8 Kgf.cm (3.47~6.94 lbf.in).

Safety Instructions

- To ensure sufficient convection cooling, always maintain a safety distance of >20 mm (0.79 inch) from all ventilated surfaces while the device is in operation.
- The device is not recommended to be placed on low thermal conductive surface, for example, plastics.
- Note that the enclosure of the device can become very hot depending on the ambient temperature and load of the power supply. Do not touch the device while it is in operation or immediately after power is turned OFF. Risk of burning!
- Do not touch the terminals while power is being supplied. Risk of electric shock.
- Prevent any foreign metal, particles or conductors to enter the device through the openings during installation. It can cause: Electric shock; Safety Hazard; Fire; Product failure
- Warning: When connecting the device, secure Earth connection before connecting L and N. When disconnecting the device, remove L and N connections before removing the Earth connection.

PMC Panel Mount Power Supply

12 V 150 W 1 Phase / PMC-12V150W1B□

Functions

■ Graph illustrating the Start-up Time, Rise Time, and Hold-up Time

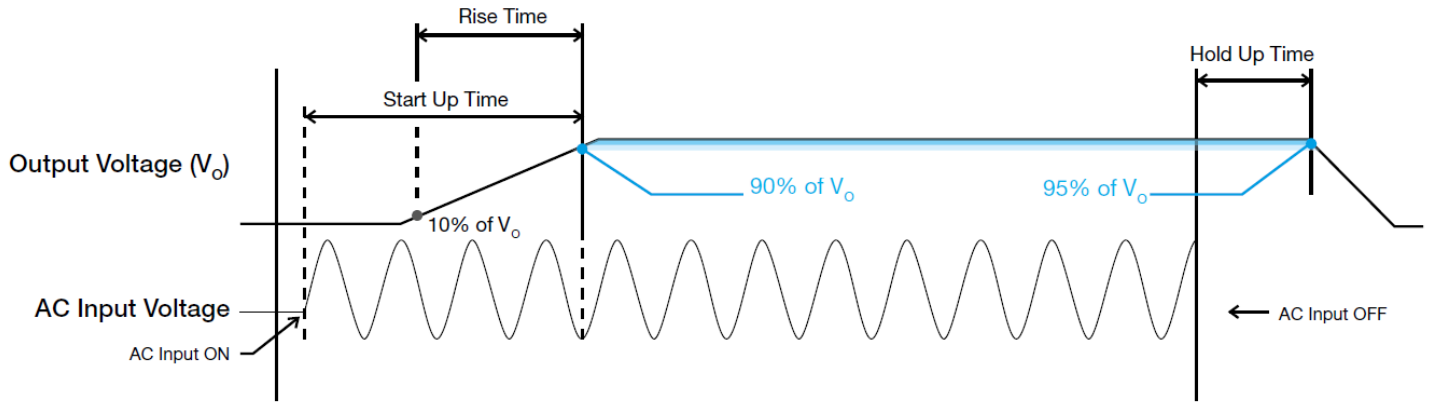

Start-up Time

The time required for the output voltage to reach 90% of its final steady state set value, after the input voltage is applied.

Rise Time

The time required for the output voltage to change from 10% to 90% of its final steady state set value.

Hold-up Time

Time between the collapse of the AC input voltage, and the output falling to 95% of its steady state set value.

Inrush Current

Inrush Current is the first surge current seen on the input side when AC input is applied to the power supply. It is the first pulse captured; see a typical picture for the inrush current as seen in the power supply.

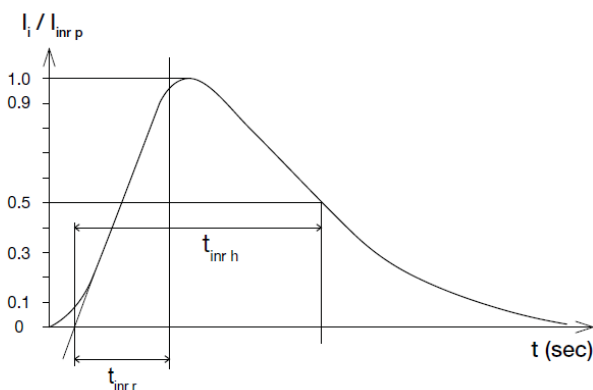

Dynamic Response

The power supply output voltage will remain within $\pm 5\%$ of its steady state value, when subjected to a dynamic load from 0% to 100% of its rated current.

■ 50% duty cycle / 5Hz

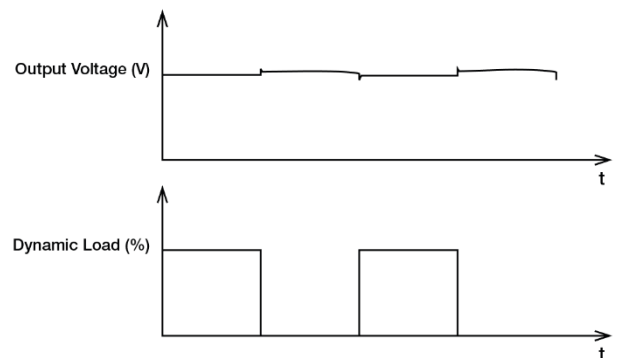

PMC Panel Mount Power Supply

12 V 150 W 1 Phase / PMC-12V150W1B□

Overload & Overcurrent Protections (Auto-Recovery)

The power supply's Overload (OLP) and Over current (OCP) Protections will be activated when output current (I_o) exceeds its specification as defined on Page 3 under "Protections. In such occurrence, the output voltage (V_o) will start to droop and once the power supply has reached its maximum power limit, the protection is activated and the power supply will go into "Hiccup mode" (Auto-Recovery). The power supply will recover once the fault condition of the OLP and OCP is removed and I_o is back within the specifications.

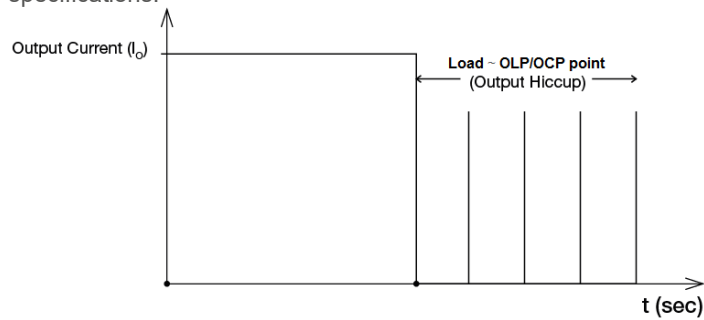

It is not recommended to prolong the duration of I_o when it is less than OLP/OCP point, but greater than 100%, since it may cause damage to the PSU.

Short Circuit Protection (Auto-Recovery)

The power supply's output OLP/OCP function also provides protection against short circuits. When a short circuit is applied, the output current will operate in "Hiccup mode", as shown in the illustration in the OLP/OCP section on this page. The power supply will return to normal operation after the short circuit is removed.

Overvoltage Protection (Auto-Recovery)

The power supply's overvoltage circuit will be activated when its internal feedback circuit fails. The output voltage shall not exceed its specifications defined on Page 3 under "Protections".

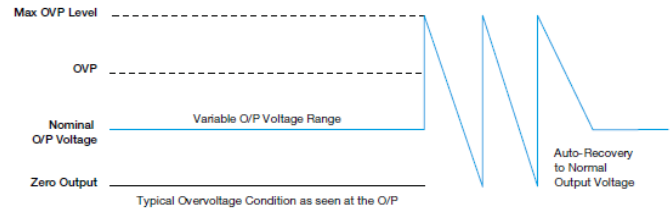

Over Temperature Protection (Auto-Recovery)

As mentioned above, the power supply also has Over Temperature Protection (OTP). This is activated when the overload condition persists for an extended duration and the output current is below the overload trigger point but >100% load. In the event of a higher operating condition at 100% load, the power supply will run into OTP when the surrounding air temperature is >75°C. When activated, the output voltage will go into bouncing mode until the operating surrounding temperature drops to 50°C or output capacity is reduced as recommended in the de-rating graph.

PMC Panel Mount Power Supply

12 V 150 W 1 Phase / PMC-12V150W1B□

Others

PFC – Norm EN 61000-3-2

Line Current harmonic

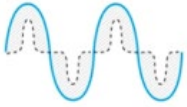

Typically, the input current waveform is not sinusoidal due to the periodical peak charging of the input capacitor. In industrial environment, complying with EN 61000-3-2 is only necessary under special conditions. Complying to this standard can have some technical drawbacks, such as lower efficiency as well as some commercial aspects such as higher purchasing costs. Frequently, the user does not profit from fulfilling this standard, therefore, it is important to know whether it is mandatory to meet this standard for a specific application.

This product conforms to this standard.

Attention

Delta provides all information in the datasheets on an “AS IS” basis and does not offer any kind of warranty through the information for using the product. In the event of any discrepancy between the information in the catalog and datasheets, the datasheets shall prevail (please refer to www.DeltaPSU.com for the latest datasheets information). Delta shall have no liability of indemnification for any claim or action arising from any error for the provided information in the datasheets. Customer shall take its responsibility for evaluation of using the product before placing an order with Delta.

Delta reserves the right to make changes to the information described in the datasheets without notice.

Manufacturer and Authorized Representatives Information

Manufacturer

Thailand

Delta Electronics (Thailand) PCL.
909 Pattana 1 Rd., Muang, Samutprakarn, 10280 Thailand

Taiwan

Delta Electronics, Inc.
3 Tungyuan Road, Chungli Industrial Zone, Taoyuan County
32063, Taiwan

Authorized Representatives

The Netherlands

Delta Greentech (Netherlands) B.V.
Zandsteen 15, 2132 MZ Hoofddorp, The Netherlands

United Kingdom

Delta Electronics Europe Limited
1 Redwood Court, Peel Park Campus,
East Kilbride, Glasgow, G74 5PF, United Kingdom