

TPS622x0EVM-229

This user's guide describes the characteristics, operation, and use of the TPS62240EVM-229 and the TPS62260EVM-229 evaluation modules (EVM). These EVMs demonstrate the Texas Instruments TPS62240 or the TPS62260, 2.25-MHz, synchronous, step-down converters. The TPS62240 supplies 300 mA of output current and the TPS62260 supplies 600 mA. This user's guide includes setup instructions, schematic diagram, bill of materials (BOM), and PCB layout drawings for the evaluation module.

Contents

1	Introduction	1
2	Setup	2
3	Operation	3
4	Test Results	3
5	Board Layout, Schematic, and Bill of Materials.....	7

List of Figures

1	TPS62240 Start-up From Enable, Vin = 3 V, Vout = 1.8 V, ILoad = 300 mA.....	3
2	TPS62240 Output Ripple, Vin = 3 V, Vout = 1.8 V, ILoad = 300 mA	4
3	TPS62240 Load Transient, 180-mA to 300-mA Step, Vin = 3 V, Vout = 1.8 V.....	4
4	TPS62240 Load Transient, 300-mA to 180-mA Step, Vin = 3 V, Vout = 1.8 V.....	5
5	TPS62260 Start-up From Enable, Vin = 3 V, Vout = 1.8 V, ILoad = 600 mA.....	5
6	TPS62260 Output Ripple, Vin = 3 V, Vout = 1.8 V, ILoad = 600 mA	6
7	TPS62260 Load Transient, 180-mA to 540-mA Step, Vin = 3 V, Vout = 1.8 V.....	6
8	TPS62260 Load Transient, 540-mA to 180-mA Step, Vin = 3 V, Vout = 1.8 V.....	7
9	Assembly Layer	8
10	Top Layer Routing	9
11	Bottom Layer Routing.....	10
12	TPS622x0EVM-229 Schematic.....	11

List of Tables

1	TPS622x0EVM-229 Bill of Materials.....	12
---	--	----

1 Introduction

The TPS62240EVM-229 and TPS62260EVM-229 evaluation modules (EVM) help designers evaluate the operation and performance of the TPS62240 and TPS62260 converters. These converters are 2.25-MHz, synchronous, step-down converters with 300 mA or 600 mA of output current, respectively.

The TPS622x0EVM-229 has two converter layouts on one board, each electrically isolated from the other. The first converter at the top of the board uses the 2-mm × 2-mm SON package (DRV) with the output voltage set to 1.8V. This converter has been designed with a maximum solution height of 1 mm. The second converter, at the bottom of the board, demonstrates the TSOT-23-6 package (DDC) with the output voltage set to 1.2V. This layout uses a taller inductor with lower losses to achieve higher efficiency than converter 1. Both layouts use the adjustable output voltage version of the converter along with 0603-sized external parts to ease soldering when evaluating different output voltages.

1.1 **Related Documentation From Texas Instruments**

- *TPS62240, 22.5 MHz 300 mA Step Down Converter in 2x2SON/TSOT23 Package* data sheet ([SLVS762](#))
- *TPS62260, TPS62261, TPS62262 22.5 MHz 600 mA Step Down Converter in 2x2SON/TSOT23 Package* data sheet ([SLVS763](#))

2 **Setup**

This section describes the jumpers and connectors on the EVM as well as how to properly connect, set up, and use the TPS622X0EVM-229.

2.1 **Input / Output Connector Descriptions**

2.1.1 **J1 – VIN – Converter 1**

This is the positive input supply voltage to converter number one. Twist the leads to the input supply and keep them as short as possible to minimize EMI transmission.

2.1.2 **J2 – GND – Converter 1**

This is the return connection for the input power supply of the converter.

2.1.3 **J3 – VOUT – Converter 1**

This is the positive connection from the output of converter number one. Connect this pin to the positive input of the load.

2.1.4 **J4 – GND – Converter 1**

This is the return connection for the output of converter number one.

2.1.5 **JP1 – ENABLE – Converter 1**

This jumper enables or disables the converter. Connecting the shorting jumper between pins 1 and 2 (VIN and EN) enables converter 1. Connecting the shorting jumper between pins 2 and 3 (EN and GND) disables converter 1.

2.1.6 **JP2 – MODE – Converter 1**

This jumper sets the mode of the TPS622x0. Connect the shorting jumper between pins 1 and 2 (VIN and MODE) forces the TPS622x0 into fixed frequency PWM mode. Connecting the shorting jumper between pins 2 and 3 (MODE and GND) enables the Power Save Mode with automatic transition from PFM mode to fixed frequency PWM mode. Never leave this pin floating.

2.1.7 **J5 – VIN – Converter 2**

This is the positive input supply voltage to converter number 2. Twist the leads to the input supply and keep them as short as possible to minimize EMI transmission.

2.1.8 **J6 – GND – Converter 2**

This is the return connection for the input power supply of the converter.

2.1.9 **J7 – VOUT – Converter 2**

This is the positive connection from the output of converter. Connect this pin to the positive input of the load.

2.1.10 J8 – GND – Converter 2

This is the return connection for the output of converter 2.

2.1.11 JP3 – ENABLE – Converter 2

This jumper enables or disables the converter. Connecting the shorting jumper between pins 1 and 2 (VIN and EN) enables converter 2. Connecting the shorting jumper between pin 2 and 3 (EN and GND) disables converter 2. Never leave this pin floating.

3 Operation

Connect the positive input power supply to J1 for converter number one or to J5 for converter number 2. Connect the input power return (ground) to J2 for converter one or J6 for converter two. The TPS622x0EVM-229 has an absolute maximum input voltage of 7 V. The recommended maximum operating voltage is 6 V.

Connect the desired load between J3 and J4 for converter number one or between J7 and J8 for converter number 2. The TPS62240EVM-229 can supply up to 300 mA of output current and the TPS62260EVM-229 can supply up to 600 mA of output current.

Configure jumpers JP1, JP2, and JP3 as required. The functions of JP1, JP2, and JP3 are described in the Set-up section of this manual.

4 Test Results

This section provides typical performance waveforms for the TPS622X0EVM-229 printed-circuit board.

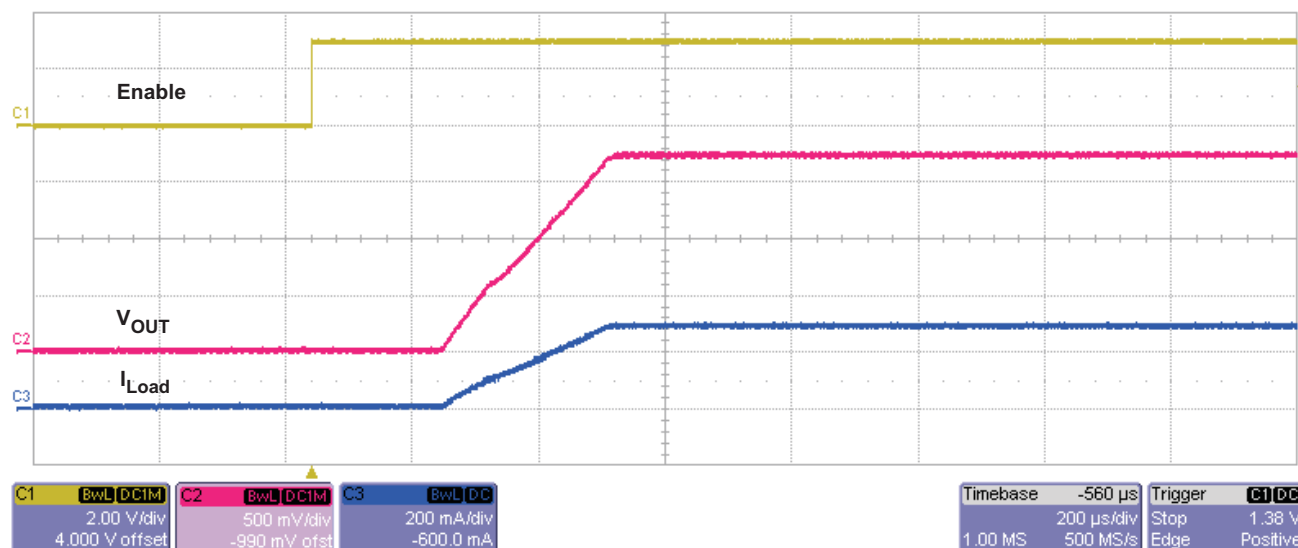

Figure 1. TPS62240 Start-up From Enable, Vin = 3 V, Vout = 1.8 V, ILoad = 300 mA

Test Results

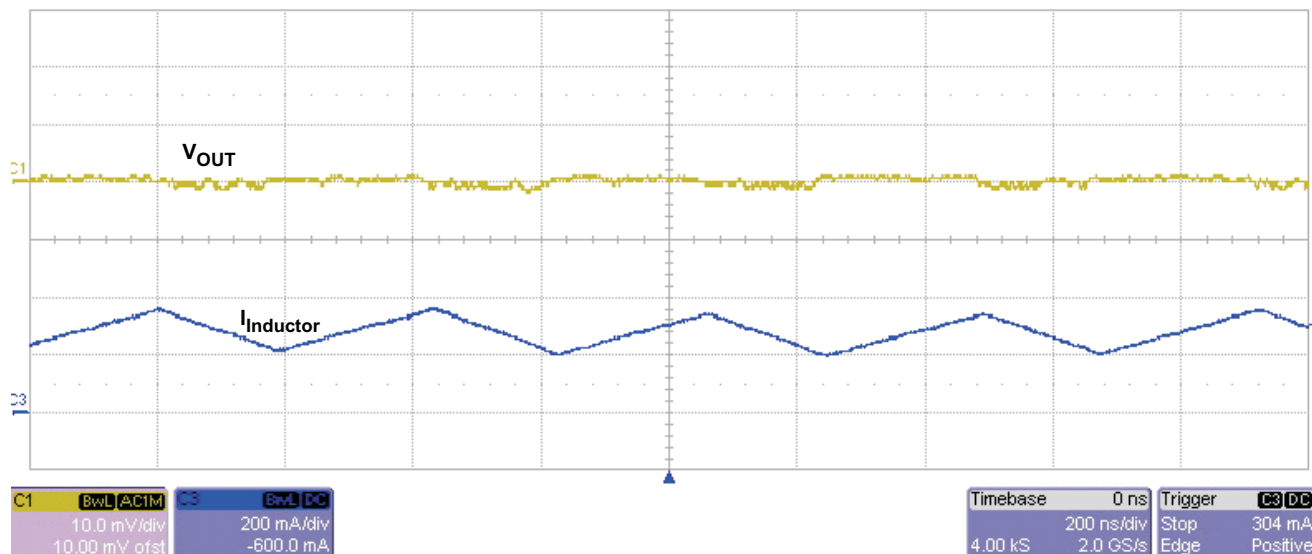

Figure 2. TPS62240 Output Ripple, $V_{in} = 3\text{ V}$, $V_{out} = 1.8\text{ V}$, $I_{Load} = 300\text{ mA}$

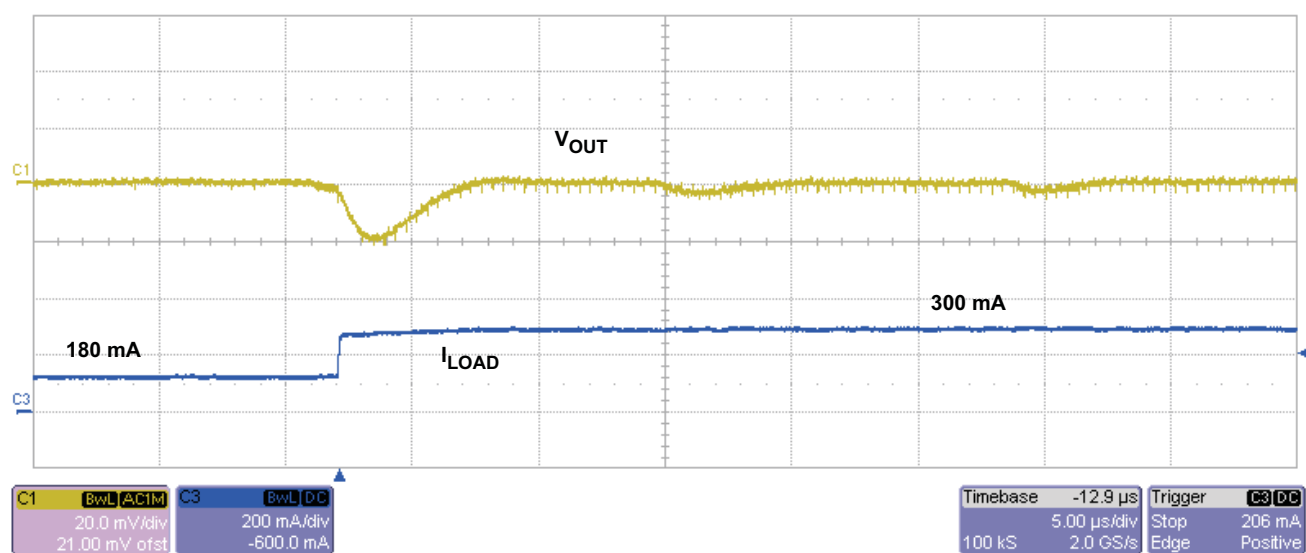

Figure 3. TPS62240 Load Transient, 180-mA to 300-mA Step, $V_{in} = 3\text{ V}$, $V_{out} = 1.8\text{ V}$

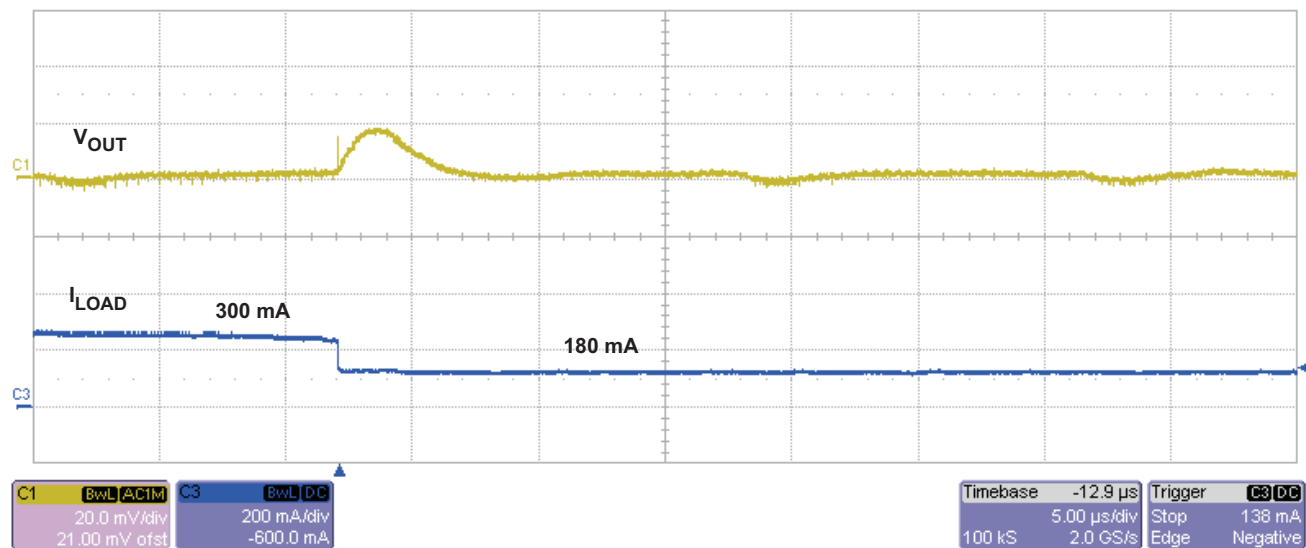

Figure 4. TPS62240 Load Transient, 300-mA to 180-mA Step, $V_{in} = 3\text{ V}$, $V_{out} = 1.8\text{ V}$

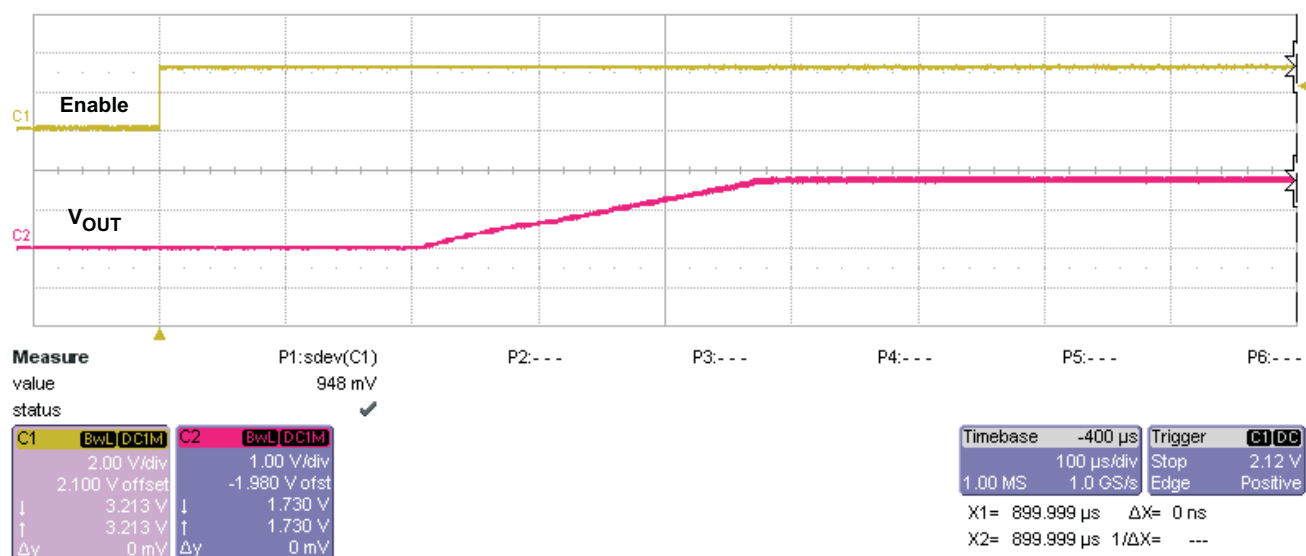

Figure 5. TPS62260 Start-up From Enable, $V_{in} = 3\text{ V}$, $V_{out} = 1.8\text{ V}$, $I_{load} = 600\text{ mA}$

Test Results

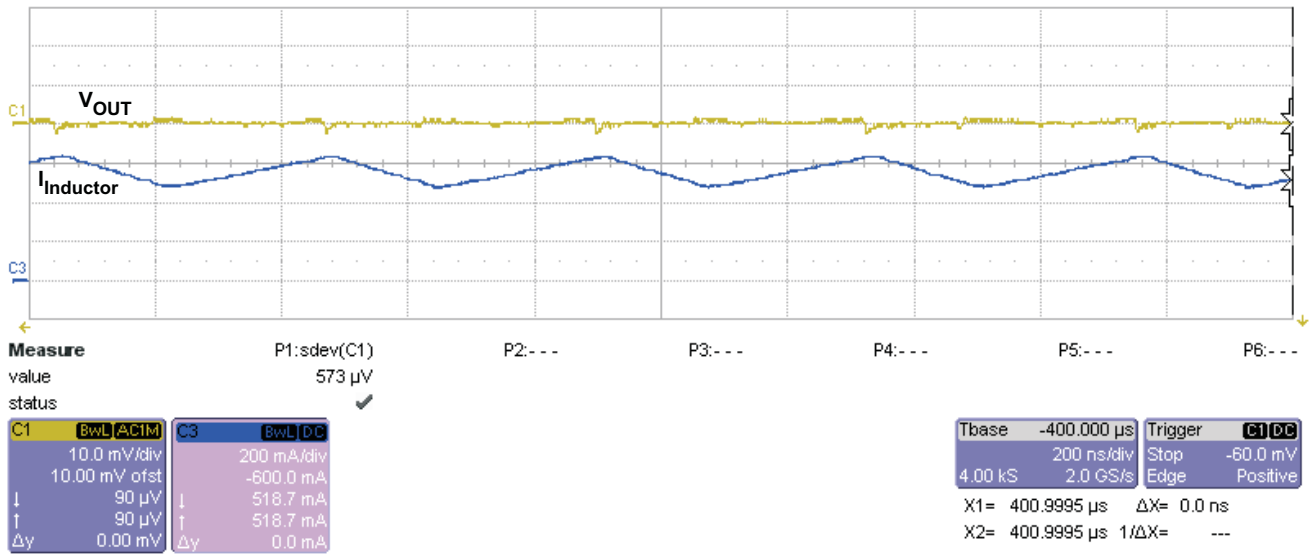

Figure 6. TPS62260 Output Ripple, Vin = 3 V, Vout = 1.8 V, ILoad = 600 mA

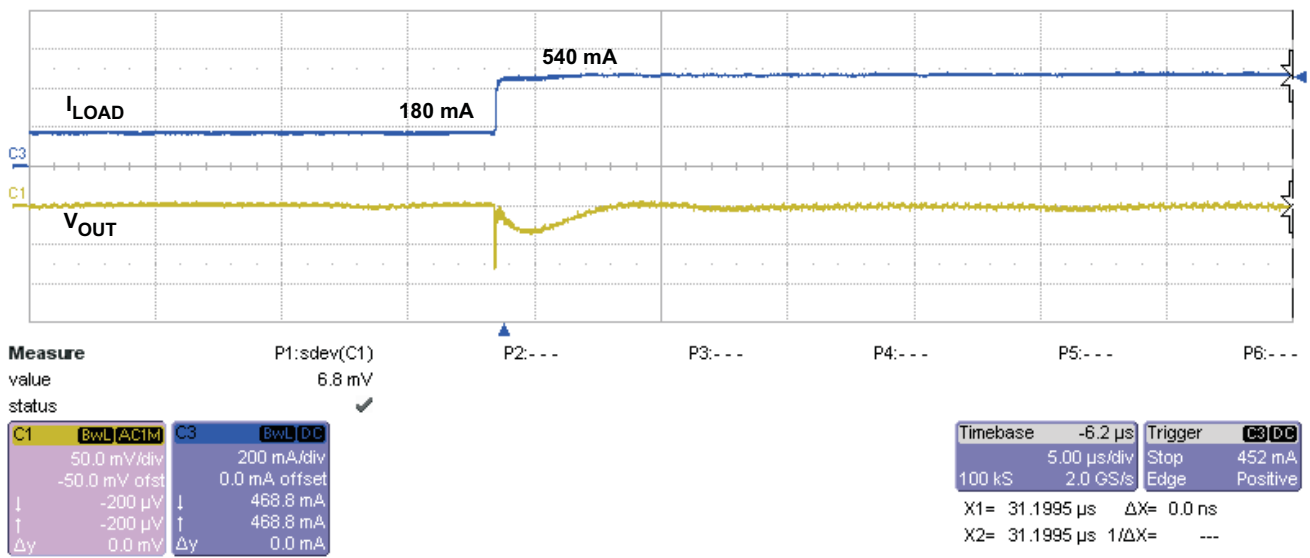

Figure 7. TPS62260 Load Transient, 180-mA to 540-mA Step, Vin = 3 V, Vout = 1.8 V

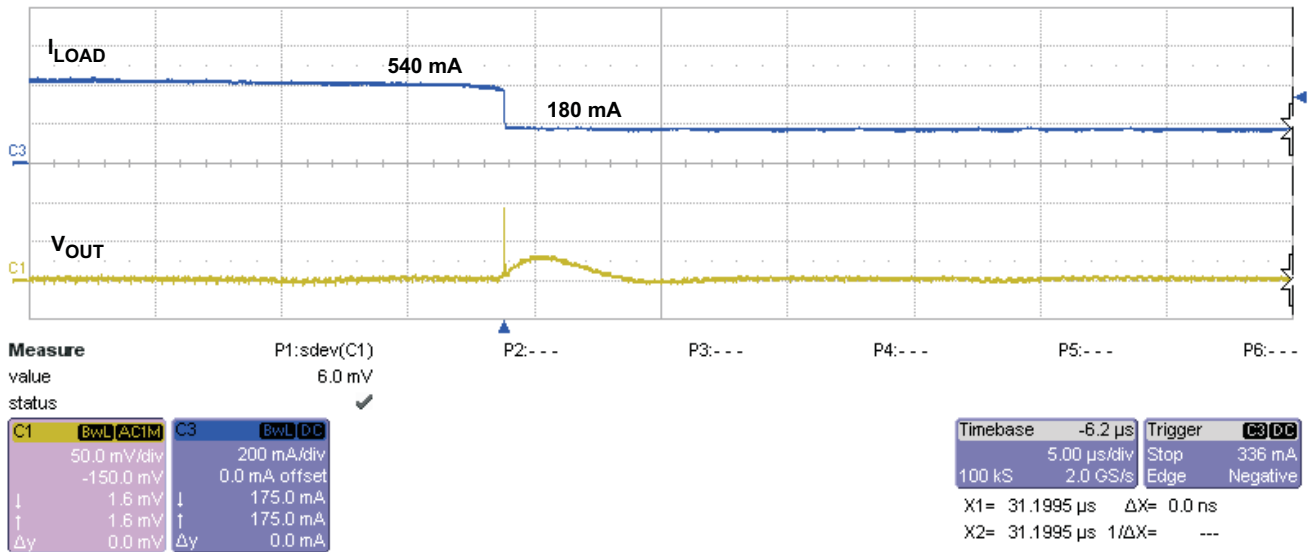

Figure 8. TPS62260 Load Transient, 540-mA to 180-mA Step, $V_{in} = 3\text{ V}$, $V_{out} = 1.8\text{ V}$

5 Board Layout, Schematic, and Bill of Materials

This section provides the TPS622X0EVM-229 board layout, schematic, and bill of materials.

5.1 Layout

Board layout is critical for all high-frequency switch mode power supplies. Figure 9 through Figure 11 show the board layout for the TPS622X0EVM-229 PCB. The nodes with high-switching frequencies and currents are kept as short as possible to minimize trace inductance. Careful attention has been given to the routing of high-frequency current loops and a single-point grounding scheme is used. See the data sheet for specific layout guidelines. Figure 12 shows the schematic for the TPS622X0EVM-229, and Table 1 shows the bill of materials.

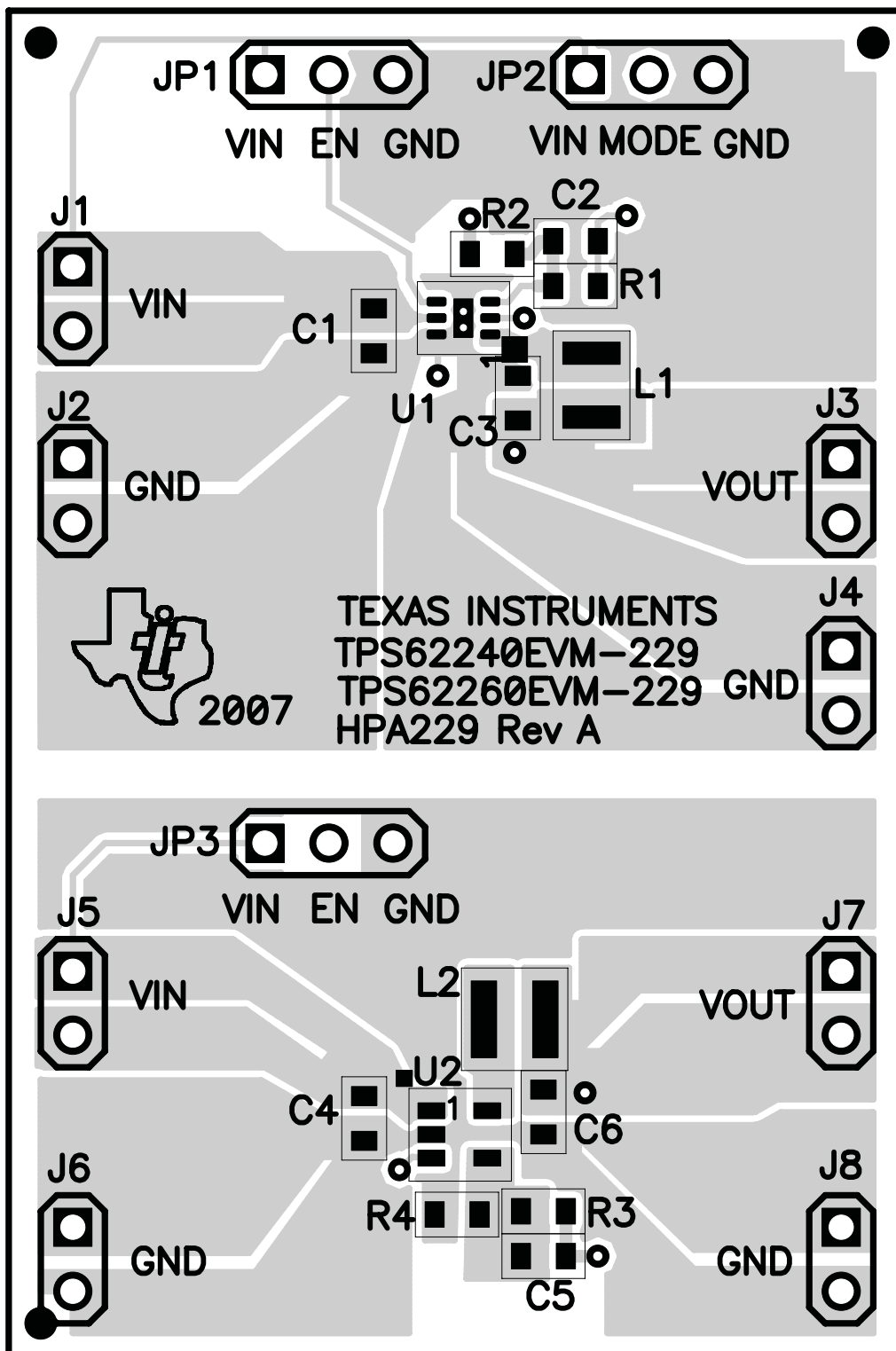

Figure 9. Assembly Layer

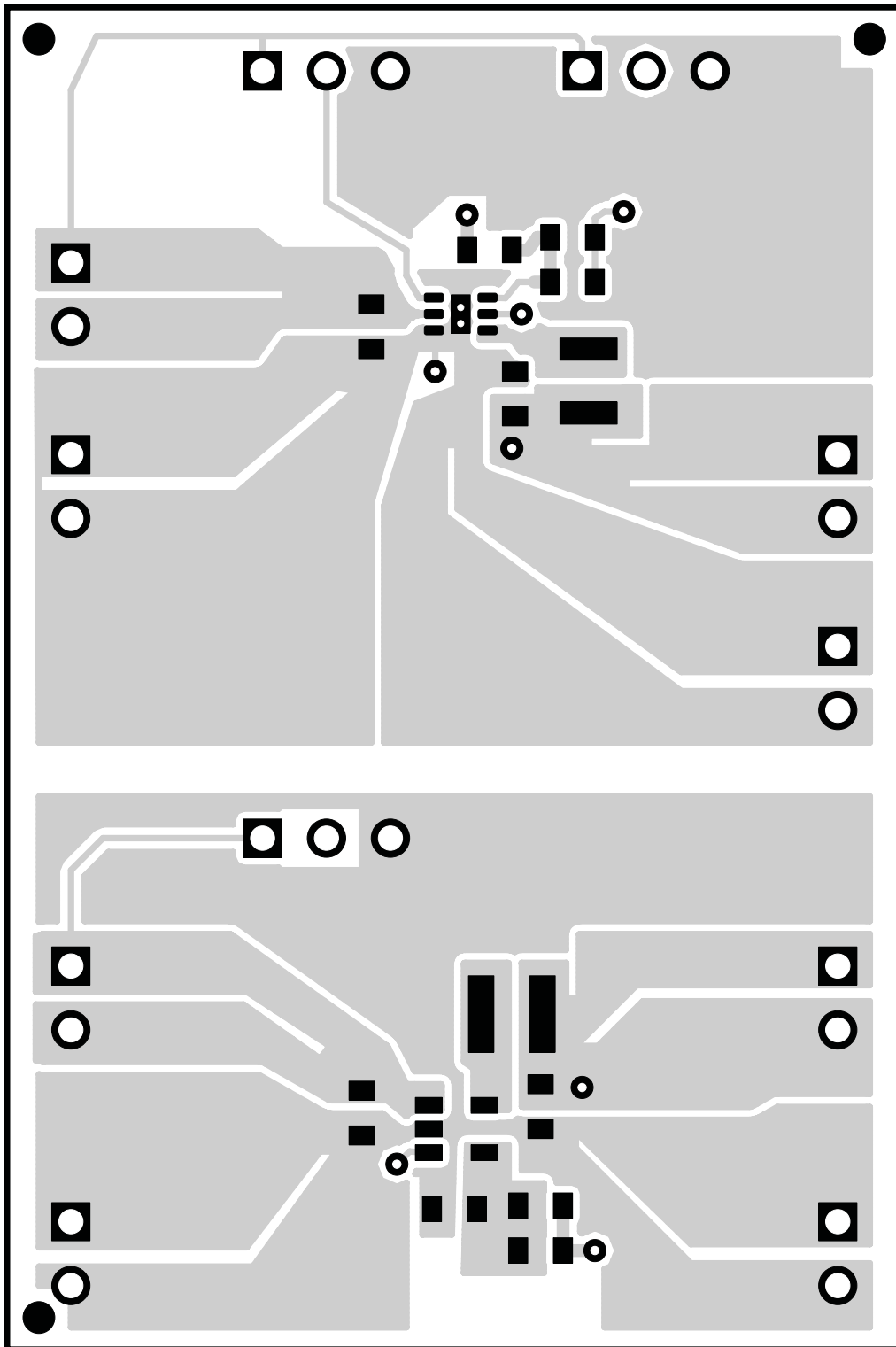

Figure 10. Top Layer Routing

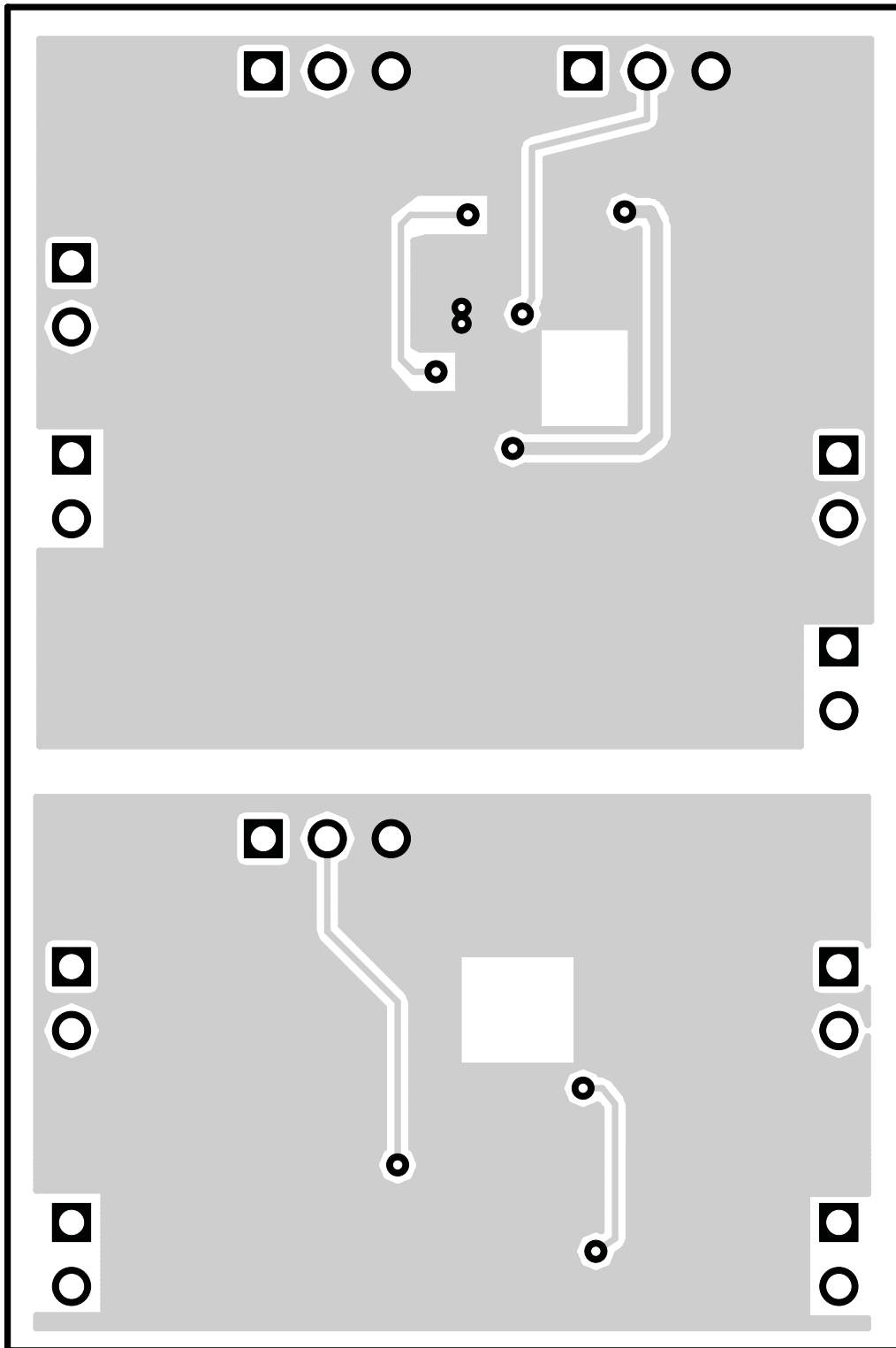

Figure 11. Bottom Layer Routing

5.2 Schematic

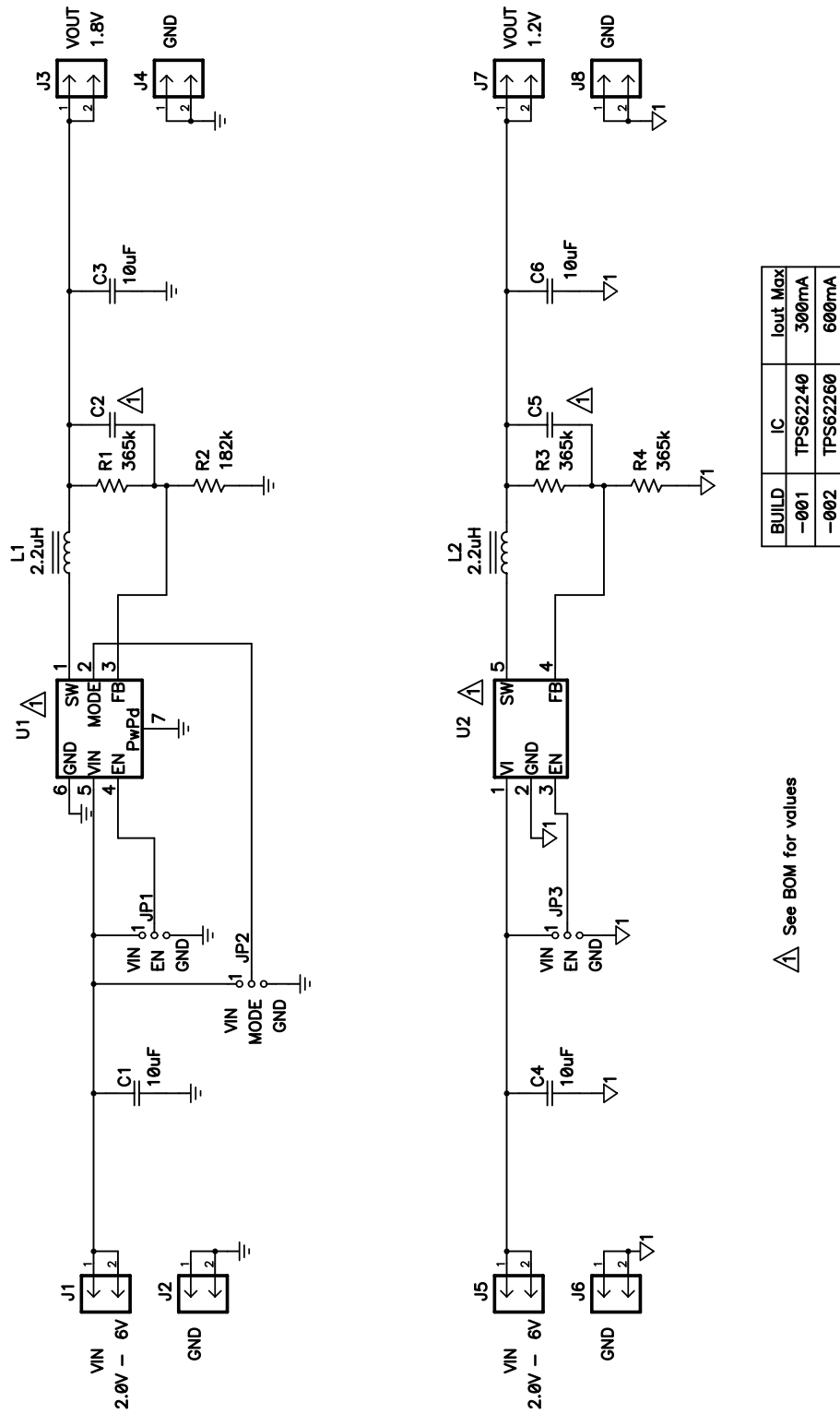

Figure 12. TPS622x0EVM-229 Schematic

5.3 Bill of Materials

Table 1 presents the bill of materials for the TPS622X0EVM-229 evaluation module.

Table 1. TPS622x0EVM-229 Bill of Materials

Count		RefDes	Value	Description	Size	Part Number	Mfr
-001	-002						
4	4	C1, C3, C4, C6	10 μ F	Capacitor, Ceramic, 6.3V, X5R, 20%	0603	GRM188R60J106ME47D	Murata
2	0	C2, C5	33 pF	Capacitor, Ceramic, 50V, C0G, 5%	0603	C1608C0G1H330J	TDK
0	2		22 pF	Capacitor, Ceramic, 50V, C0G, 5%	0603	C1608C0G1H220J	TDK
8	8	J1-J8		Header, 2 pin, 100mil spacing (36-pin strip)	1.100x2	PTC36SAAN	Sullins
3	3	JP1-JP3		Header, 3 pin, 100mil spacing (36-pin strip)	1.100x3	PTC36SAAN	Sullins
1	0	L1	2.2 μ H	Inductor, SMT Multilayer, 1.3A, 80m Ω	2520 mm	MIPF2520D2R2	FDK Corp.
0	1		2.2 μ H	Inductor, SMT Multilayer, 1.2A, 110m Ω	2520 mm	MIPS2520D2R2	FDK Corp.
1	1	L2	2.2 μ H	Inductor, SMT, 1.5A, 110m Ω	0.118 x 0.118	LPS3015-222ML	Coilcraft
3	3	R1, R3, R4	365 k Ω	Resistor, Chip, 1/16W, 1%	0603	Std	Std
1	1	R2	182 k Ω	Resistor, Chip, 1/16W, 1%	0603	Std	Std
1	0	U1		IC, 2.25MHz 300mA Step-down Converter	SON-6 (DRV)	TPS62240DRV	TI
0	1			IC, 2.25MHz 600mA Step-down Converter	SON-6 (DRV)	TPS62260DRV	TI
1	0	U2		IC, 2.25MHz 300mA Step-down Converter	SOT23-5	TPS62240DDC	TI
0	1			IC, 2.25MHz 600mA Step-down Converter	SOT23-5	TPS62260DDC	TI
1	1	-		PCB, 2.1 In x 1.4 In x 0.062 In		HPA229	Any
3	3	-		Shunt, 100mil, Black	0.100	929950-00	

EVALUATION BOARD/KIT IMPORTANT NOTICE

Texas Instruments (TI) provides the enclosed product(s) under the following conditions:

This evaluation board/kit is intended for use for **ENGINEERING DEVELOPMENT, DEMONSTRATION, OR EVALUATION PURPOSES ONLY** and is not considered by TI to be a finished end-product fit for general consumer use. Persons handling the product(s) must have electronics training and observe good engineering practice standards. As such, the goods being provided are not intended to be complete in terms of required design-, marketing-, and/or manufacturing-related protective considerations, including product safety and environmental measures typically found in end products that incorporate such semiconductor components or circuit boards. This evaluation board/kit does not fall within the scope of the European Union directives regarding electromagnetic compatibility, restricted substances (RoHS), recycling (WEEE), FCC, CE or UL, and therefore may not meet the technical requirements of these directives or other related directives.

Should this evaluation board/kit not meet the specifications indicated in the User's Guide, the board/kit may be returned within 30 days from the date of delivery for a full refund. **THE FOREGOING WARRANTY IS THE EXCLUSIVE WARRANTY MADE BY SELLER TO BUYER AND IS IN LIEU OF ALL OTHER WARRANTIES, EXPRESSED, IMPLIED, OR STATUTORY, INCLUDING ANY WARRANTY OF MERCHANTABILITY OR FITNESS FOR ANY PARTICULAR PURPOSE.**

The user assumes all responsibility and liability for proper and safe handling of the goods. Further, the user indemnifies TI from all claims arising from the handling or use of the goods. Due to the open construction of the product, it is the user's responsibility to take any and all appropriate precautions with regard to electrostatic discharge.

EXCEPT TO THE EXTENT OF THE INDEMNITY SET FORTH ABOVE, NEITHER PARTY SHALL BE LIABLE TO THE OTHER FOR ANY INDIRECT, SPECIAL, INCIDENTAL, OR CONSEQUENTIAL DAMAGES.

TI currently deals with a variety of customers for products, and therefore our arrangement with the user **is not exclusive.**

TI assumes **no liability for applications assistance, customer product design, software performance, or infringement of patents or services described herein.**

Please read the User's Guide and, specifically, the Warnings and Restrictions notice in the User's Guide prior to handling the product. This notice contains important safety information about temperatures and voltages. For additional information on TI's environmental and/or safety programs, please contact the TI application engineer or visit www.ti.com/esh.

No license is granted under any patent right or other intellectual property right of TI covering or relating to any machine, process, or combination in which such TI products or services might be or are used.

FCC Warning

This evaluation board/kit is intended for use for **ENGINEERING DEVELOPMENT, DEMONSTRATION, OR EVALUATION PURPOSES ONLY** and is not considered by TI to be a finished end-product fit for general consumer use. It generates, uses, and can radiate radio frequency energy and has not been tested for compliance with the limits of computing devices pursuant to part 15 of FCC rules, which are designed to provide reasonable protection against radio frequency interference. Operation of this equipment in other environments may cause interference with radio communications, in which case the user at his own expense will be required to take whatever measures may be required to correct this interference.

EVM WARNINGS AND RESTRICTIONS

It is important to operate this EVM within the input voltage range of 2 V to 6 V and the output voltage range of 0.6 V to 6 V.

Exceeding the specified input range may cause unexpected operation and/or irreversible damage to the EVM. If there are questions concerning the input range, please contact a TI field representative prior to connecting the input power.

Applying loads outside of the specified output range may result in unintended operation and/or possible permanent damage to the EVM. Please consult the EVM User's Guide prior to connecting any load to the EVM output. If there is uncertainty as to the load specification, please contact a TI field representative.

During normal operation, some circuit components may have case temperatures greater than 85°C. The EVM is designed to operate properly with certain components above 85°C as long as the input and output ranges are maintained. These components include but are not limited to linear regulators, switching transistors, pass transistors, and current sense resistors. These types of devices can be identified using the EVM schematic located in the EVM User's Guide. When placing measurement probes near these devices during operation, please be aware that these devices may be very warm to the touch.

Mailing Address: Texas Instruments, Post Office Box 655303, Dallas, Texas 75265
Copyright © 2007, Texas Instruments Incorporated

IMPORTANT NOTICE

Texas Instruments Incorporated and its subsidiaries (TI) reserve the right to make corrections, modifications, enhancements, improvements, and other changes to its products and services at any time and to discontinue any product or service without notice. Customers should obtain the latest relevant information before placing orders and should verify that such information is current and complete. All products are sold subject to TI's terms and conditions of sale supplied at the time of order acknowledgment.

TI warrants performance of its hardware products to the specifications applicable at the time of sale in accordance with TI's standard warranty. Testing and other quality control techniques are used to the extent TI deems necessary to support this warranty. Except where mandated by government requirements, testing of all parameters of each product is not necessarily performed.

TI assumes no liability for applications assistance or customer product design. Customers are responsible for their products and applications using TI components. To minimize the risks associated with customer products and applications, customers should provide adequate design and operating safeguards.

TI does not warrant or represent that any license, either express or implied, is granted under any TI patent right, copyright, mask work right, or other TI intellectual property right relating to any combination, machine, or process in which TI products or services are used. Information published by TI regarding third-party products or services does not constitute a license from TI to use such products or services or a warranty or endorsement thereof. Use of such information may require a license from a third party under the patents or other intellectual property of the third party, or a license from TI under the patents or other intellectual property of TI.

Reproduction of TI information in TI data books or data sheets is permissible only if reproduction is without alteration and is accompanied by all associated warranties, conditions, limitations, and notices. Reproduction of this information with alteration is an unfair and deceptive business practice. TI is not responsible or liable for such altered documentation. Information of third parties may be subject to additional restrictions.

Resale of TI products or services with statements different from or beyond the parameters stated by TI for that product or service voids all express and any implied warranties for the associated TI product or service and is an unfair and deceptive business practice. TI is not responsible or liable for any such statements.

TI products are not authorized for use in safety-critical applications (such as life support) where a failure of the TI product would reasonably be expected to cause severe personal injury or death, unless officers of the parties have executed an agreement specifically governing such use. Buyers represent that they have all necessary expertise in the safety and regulatory ramifications of their applications, and acknowledge and agree that they are solely responsible for all legal, regulatory and safety-related requirements concerning their products and any use of TI products in such safety-critical applications, notwithstanding any applications-related information or support that may be provided by TI. Further, Buyers must fully indemnify TI and its representatives against any damages arising out of the use of TI products in such safety-critical applications.

TI products are neither designed nor intended for use in military/aerospace applications or environments unless the TI products are specifically designated by TI as military-grade or "enhanced plastic." Only products designated by TI as military-grade meet military specifications. Buyers acknowledge and agree that any such use of TI products which TI has not designated as military-grade is solely at the Buyer's risk, and that they are solely responsible for compliance with all legal and regulatory requirements in connection with such use.

TI products are neither designed nor intended for use in automotive applications or environments unless the specific TI products are designated by TI as compliant with ISO/TS 16949 requirements. Buyers acknowledge and agree that, if they use any non-designated products in automotive applications, TI will not be responsible for any failure to meet such requirements.

Following are URLs where you can obtain information on other Texas Instruments products and application solutions:

Products		Applications	
Amplifiers	amplifier.ti.com	Audio	www.ti.com/audio
Data Converters	dataconverter.ti.com	Automotive	www.ti.com/automotive
DSP	dsp.ti.com	Broadband	www.ti.com/broadband
Interface	interface.ti.com	Digital Control	www.ti.com/digitalcontrol
Logic	logic.ti.com	Military	www.ti.com/military
Power Mgmt	power.ti.com	Optical Networking	www.ti.com/opticalnetwork
Microcontrollers	microcontroller.ti.com	Security	www.ti.com/security
RFID	www.ti-rfid.com	Telephony	www.ti.com/telephony
Low Power Wireless	www.ti.com/lpw	Video & Imaging	www.ti.com/video
		Wireless	www.ti.com/wireless

Mailing Address: Texas Instruments, Post Office Box 655303, Dallas, Texas 75265
Copyright © 2007, Texas Instruments Incorporated