

**User Manual**

# **ARK-DS306**

**Compact Digital Signage  
Computer**

**ADVANTECH**

*Enabling an Intelligent Planet*

---

## Copyright

The documentation and the software included with this product are copyrighted 2011 by Advantech Co., Ltd. All rights are reserved. Advantech Co., Ltd. reserves the right to make improvements in the products described in this manual at any time without notice.

No part of this manual may be reproduced, copied, translated or transmitted in any form or by any means without the prior written permission of Advantech Co., Ltd. Information provided in this manual is intended to be accurate and reliable. However, Advantech Co., Ltd. assumes no responsibility for its use, nor for any infringements of the rights of third parties, which may result from its use.

## Acknowledgements

Award is a trademark of Award Software International, Inc.

IBM, PC/AT, PS/2 and VGA are trademarks of International Business Machines Corporation.

AMD™ is a trademark of AMD Corporation.

Microsoft Windows® is a registered trademark of Microsoft Corp.

RTL is a trademark of Realtek Semi-Conductor Co., Ltd.

ESS is a trademark of ESS Technology, Inc.

UMC is a trademark of United Microelectronics Corporation.

SMI is a trademark of Silicon Motion, Inc.

Creative is a trademark of Creative Technology LTD.

CHRONTEL is a trademark of Chrontel Inc.

All other product names or trademarks are properties of their respective owners.

For more information about this and other Advantech products, please visit our website at:

<http://www.advantech.com/>

For technical support and service, please visit our support website at:

<http://support.advantech.com.tw/support/>

## Product Warranty (2 years)

Advantech warrants to you, the original purchaser, that each of its products will be free from defects in materials and workmanship for two years from the date of purchase.

This warranty does not apply to any products which have been repaired or altered by persons other than repair personnel authorized by Advantech, or which have been subject to misuse, abuse, accident or improper installation. Advantech assumes no liability under the terms of this warranty as a consequence of such events.

Because of Advantech's high quality-control standards and rigorous testing, most of our customers never need to use our repair service. If an Advantech product is defective, it will be repaired or replaced at no charge during the warranty period. For out-of-warranty repairs, you will be billed according to the cost of replacement materials, service time and freight. Please consult your dealer for more details.

If you think you have a defective product, follow these steps:

1. Collect all the information about the problem encountered. (For example, CPU speed, Advantech products used, other hardware and software used, etc.) Note anything abnormal and list any onscreen messages you get when the problem occurs.
2. Call your dealer and describe the problem. Please have your manual, product, and any helpful information readily available.
3. If your product is diagnosed as defective, obtain an RMA (return merchandise authorization) number from your dealer. This allows us to process your return more quickly.
4. Carefully pack the defective product, a fully-completed Repair and Replacement Order Card and a photocopy of the proof of purchase date (such as your sales receipt) in a shippable container. A product returned without proof of the purchase date is not eligible for warranty service.
5. Write the RMA number visibly on the outside of the package and ship it prepaid to your dealer.

## Declaration of Conformity

### FCC Class A

Note: This equipment has been tested and found to comply with the limits for a Class A digital device, pursuant to part 15 of the FCC Rules. These limits are designed to provide reasonable protection against harmful interference when the equipment is operated in a commercial environment. This equipment generates, uses, and can radiate radio frequency energy and, if not installed and used in accordance with the instruction manual, may cause harmful interference to radio communications. Operation of this equipment in a residential area is likely to cause harmful interference in which case the user will be required to correct the interference at his own expense.

---

## Technical Support and Assistance

1. Visit the Advantech website at [www.advantech.com/support](http://www.advantech.com/support) where you can find the latest information about the product.
2. Contact your distributor, sales representative, or Advantech's customer service center for technical support if you need additional assistance. Please have the following information ready before you call:
  - Product name and serial number
  - Description of your peripheral attachments
  - Description of your software (operating system, version, application software, etc.)
  - A complete description of the problem
  - The exact wording of any error messages

## Warnings, Cautions and Notes

**Warning!** *Warnings indicate conditions, which if not observed, can cause personal injury!*



**Caution!** *Cautions are included to help you avoid damaging hardware or losing data. e.g.*



*There is a danger of a new battery exploding if it is incorrectly installed. Do not attempt to recharge, force open, or heat the battery. Replace the battery only with the same or equivalent type recommended by the manufacturer. Discard used batteries according to the manufacturer's instructions.*

**Note!** *Notes provide optional additional information.*



# Safety Instructions

1. Read these safety instructions carefully.
2. Keep this User Manual for later reference.
3. Disconnect this equipment from any AC outlet before cleaning. Use a damp cloth. Do not use liquid or spray detergents for cleaning.
4. For plug-in equipment, the power outlet socket must be located near the equipment and must be easily accessible.
5. Keep this equipment away from humidity.
6. Put this equipment on a reliable surface during installation. Dropping it or letting it fall may cause damage.
7. The openings on the enclosure are for air convection. Protect the equipment from overheating. **DO NOT COVER THE OPENINGS.**
8. Make sure the voltage of the power source is correct before connecting the equipment to the power outlet.
9. Position the power cord so that people cannot step on it. Do not place anything over the power cord.
10. All cautions and warnings on the equipment should be noted.
11. If the equipment is not used for a long time, disconnect it from the power source to avoid damage by transient overvoltage.
12. Never pour any liquid into an opening. This may cause fire or electrical shock.
13. Never open the equipment. For safety reasons, the equipment should be opened only by qualified service personnel.
14. If one of the following situations arises, get the equipment checked by service personnel:
  - The power cord or plug is damaged.
  - Liquid has penetrated the equipment.
  - The equipment has been exposed to moisture.
  - The equipment does not work well, or you cannot get it to work according to the user's manual.
  - The equipment has been dropped and damaged.
  - The equipment has obvious signs of breakage.
15. **DO NOT LEAVE THIS EQUIPMENT IN AN ENVIRONMENT WHERE THE STORAGE TEMPERATURE MAY GO BELOW -20° C (-4° F) OR ABOVE 60° C (140° F). THIS COULD DAMAGE THE EQUIPMENT. THE EQUIPMENT SHOULD BE IN A CONTROLLED ENVIRONMENT.**
16. **CAUTION: DANGER OF EXPLOSION IF BATTERY IS INCORRECTLY REPLACED. REPLACE ONLY WITH THE SAME OR EQUIVALENT TYPE RECOMMENDED BY THE MANUFACTURER, DISCARD USED BATTERIES ACCORDING TO THE MANUFACTURER'S INSTRUCTIONS.**

The sound pressure level at the operator's position according to IEC 704-1:1982 is no more than 70 dB (A).

**RESTRICTED ACCESS AREA:** The equipment should only be installed in a Restricted Access Area.

**DISCLAIMER:** This set of instructions is given according to IEC 704-1. Advantech disclaims all responsibility for the accuracy of any statements contained herein.

## Packing List

Before installation, please ensure the following items have been shipped:

- 1 x ARK-DS306 Unit
- 1 x Driver/Utility CD/manual
- 1 x China RoHS
- 1 x Simplified Chinese User Manual for CCC
- 1 x Mounting plate set
- 1 x Power adapter AC 90-264 V, 36 W

## Power Cord

Part Number	Description
1700001524	Power cable 3-pin 180 cm, US/UL
170203183C	Power cable 3-pin 183 cm, EU
170203180A	Power cable 3-pin 180 cm, UK
1700008921	Power cable 3-pin 180 cm, PSE compatible for Japan
1700019146	Power cable 3-pin 183 cm, CCC

## Optional Accessories

Model Number	Description
AMO-WIFI01E	WIFI 802.11 b/g/n miniPCIe module (w/ cable and antenna)
AMO-HSDPA01E	HSDPA mini PCIe module (w/ antenna)
AMK-V001E	VESA Mount Kit
AMK-V002E	VESA Mount Kit for ARM

# Contents

<b>Chapter 1</b>	<b>General Introduction .....</b>	<b>1</b>
1.1	Introduction .....	2
1.2	Product Features.....	2
1.2.1	General .....	2
1.2.2	Display .....	2
1.2.3	Power Consumption.....	2
1.3	Hardware Specifications .....	2
1.4	Mechanical Specifications.....	3
1.4.1	Dimensions .....	3
	Figure 1.1 ARK-DS306 Mechanical Dimensions .....	3
1.4.2	Weight.....	3
1.5	Power Requirements.....	3
1.5.1	System Power.....	3
1.5.2	RTC Battery .....	3
1.6	Environment Specification.....	3
1.6.1	Operating Temperature.....	3
1.6.2	Relative Humidity .....	4
1.6.3	Storage Temperature.....	4
1.6.4	Vibration Loading During Operation.....	4
1.6.5	Shock During Operation.....	4
1.6.6	Safety.....	4
1.6.7	EMC .....	4
<b>Chapter 2</b>	<b>Hardware Installation .....</b>	<b>5</b>
2.1	ARK-DS306 I/O Connectors .....	6
	Figure 2.1 ARK-DS306 Front View .....	6
	Figure 2.2 ARK-DS306 Rear View .....	6
2.2	ARK-DS306 Front Side External I/O Connectors.....	6
2.2.1	Power ON/OFF Button.....	6
	Figure 2.3 Power ON/OFF Button .....	6
2.2.2	USB Connectors .....	6
	Figure 2.4 USB Port Connector .....	6
	Table 2.1: USB Port Pin Assignments .....	7
2.2.3	HDMI Connector .....	7
	Figure 2.5 HDMI Connector .....	7
	Table 2.2: HDMI Connector Pin Assignments .....	7
2.2.4	VGA Connector.....	8
	Figure 2.6 VGA Connector .....	8
	Table 2.3: VGA Connector Pin Assignments.....	8
2.2.5	LAN Connectors.....	8
	Figure 2.7 Ethernet Connector .....	8
	Table 2.4: LAN Connector Pin Assignments .....	9
2.2.6	DC Input connector .....	9
	Figure 2.8 Power Input Connector .....	9
2.3	ARK-DS306 Rear Side External I/O Connectors .....	10
2.3.1	COM Connectors .....	10
	Figure 2.9 COM connector .....	10
	Table 2.5: COM Port Pin Assignments.....	10
2.3.2	Audio Connector .....	10
	Figure 2.10 MIC, Line-in and Line-out Connector.....	10
2.4	HW Installation .....	11
2.4.1	Memory & HDD Installation.....	11
	Figure 2.11 Memory & HDD Installation .....	11

2.4.2	CFAST Card Installation .....	12
	Figure 2.12 CFAST card Installation.....	12
2.4.3	Mini PCIe WLAN Installation.....	12
	Figure 2.13 Mini PCIe WLAN Installation .....	12

## **Chapter 3 BIOS Settings ..... 13**

3.1	Introduction .....	14
3.2	Entering Setup .....	15
3.2.1	Main Setup.....	15
3.2.2	Advanced BIOS Features Setup.....	16
3.2.3	Chipset Configuration .....	23
3.2.4	Boot Configuration .....	27
3.2.5	Security Configuration .....	28
3.2.6	Save & Exit .....	29

## **Chapter 4 Software Installation ..... 31**

4.1	Driver Installation .....	32
4.1.1	CPU Driver Installation .....	32
4.1.2	LAN Driver Installation .....	39
4.1.3	Audio Driver Installation.....	42



# Chapter 1

## General Introduction

This chapter gives background information on ARK-DS306 series.

## 1.1 Introduction

Advantech ARK-DS306 is a cost effective, energy-saving and fanless digital signage media player that uses AMD G-series dual core APU with FCH M1 chipset solution. ARK-DS306 can support up to 1080p full HD video playback performance via many popular players and content formats. ARKDS306 also can support dual content output via the HDMI and VGA ports. I/O interface include: two USB 2.0, two COM ports and audio function for diversified applications. Furthermore, unlike consumer-grade, off-the-shelf, thin client products, Advantech ARK-DS306 comes with specific BIOS settings for digital signage applications, such as system Wake-on-LAN, Power On after Power Failure setting, power on timer setting. The embedded watchdog timer allows for near 100% uptime.

## 1.2 Product Features

### 1.2.1 General

- AMD T40N dual core 1.0 GHz APU + M1 FCH
- Supports dual display VGA + HDMI
- Supports 2 x GbE , 2 x USB 2.0, 2 x COM and audio functions
- Internal 2.5-inch SATA HDD drive bay and Cfast slot
- Built-in MiniPCIe slot for easy expansion e.g. WiFi, TV-tuner, etc
- Easy integration and easy maintenance

### 1.2.2 Display

- Dual-display support; up to 1080p full HD video playback performance (but subject to the video media format and playback software)

### 1.2.3 Power Consumption

- **Typical:** 9 W (w/o expansion)
- **Max.:** 13 W (w/o expansion)

## 1.3 Hardware Specifications

- **CPU:** AMD T40N dual core 1.0 GHz
- **System Chipset:** AMD M1 FCH
- **BIOS:** AMI EFI 16 Mbit Flash BIOS
- **System Memory:** 1 x 204-pin SODIMM socket DDR3 up to 4 GB
- **Graphic chipset:** Integrated AMD T40N APU
- **SSD:** Supports 1 x Cfast Card slot
- **HDD:** Supports 1 x 2.5" SATA HDD drive bay
- **Watchdog Timer:** Single chip watchdog 255-level interval timer, setup by software
- **I/O Interface:** 2 x RS-232
- **USB:** 2 x USB 2.0 compliant ports
- **Audio:** Supports line-out, microphone-in and Line-in
- **Ethernet Chipset:** 2 x Realtek RTL811E-VB-GR (Gigabit LAN)
  - **Speed:** 10/100/1000 Mbps
  - **Interface:** 2 x RJ-45 jacks with LED
  - **Standard:** IEEE 802.3z/ab (1000 Base-T) or IEEE 802.3u 100 Base-T compliant

- **Expansion:**
  - miniPCIe: 1 socket
- **Resolution:**
  - VGA: up to 1920 x 1080 at 60 Hz;
  - HDMI: up to 1920 x 1080 at 60 Hz (1080P)
- **Dual Independent: VGA + HDMI**

## 1.4 Mechanical Specifications

### 1.4.1 Dimensions

204.0 x 118.2 x 47.4 mm (8.03" x 4.65" x 1.87")

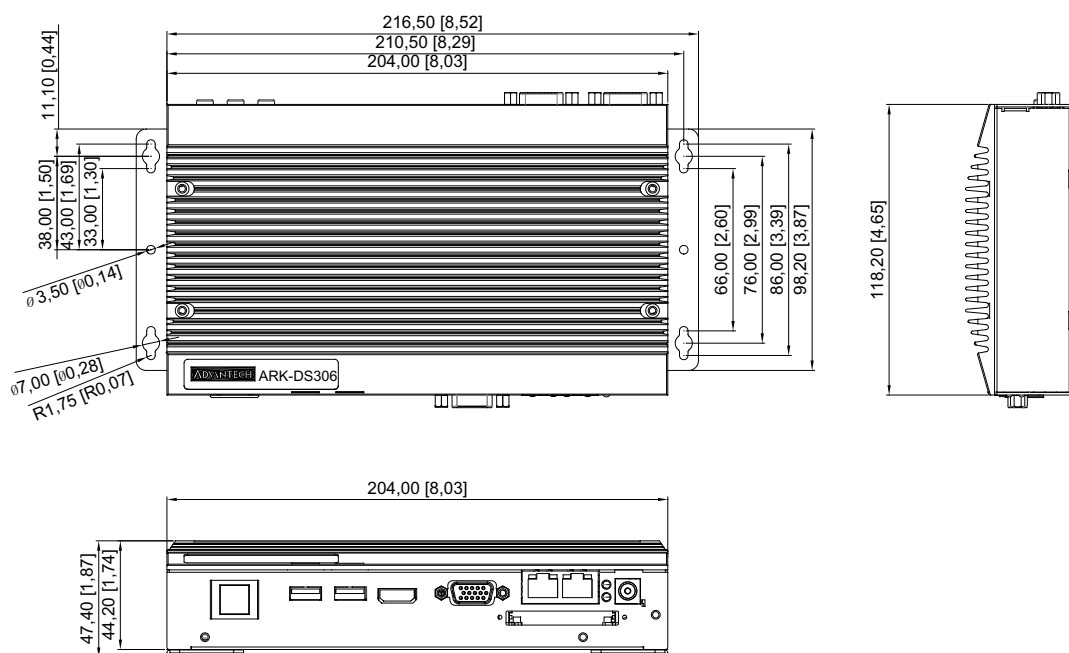

Figure 1.1 ARK-DS306 Mechanical Dimensions

### 1.4.2 Weight

1.1 kg (2.42 lb.)

## 1.5 Power Requirements

### 1.5.1 System Power

Minimum power input: DC 12 V, 3 A

### 1.5.2 RTC Battery

3 V/210 mA

## 1.6 Environment Specification

### 1.6.1 Operating Temperature

0° C ~ 40° C (32 ~ 104° F) w/ HDD; 0° C ~ 50° C (32 ~ 122° F) w/ Cfast card

---

## **1.6.2 Relative Humidity**

95% @ 40° C (non-condensing)

## **1.6.3 Storage Temperature**

-20 ~ 70° C (-4 ~ 167° F)

## **1.6.4 Vibration Loading During Operation**

1 Grms, IEC 60068-2-64, random, 5 ~ 500 Hz, 1 Oct./min, 1 hr/axis.

## **1.6.5 Shock During Operation**

20 G, IEC 60068-2-27, half sine, 11 ms duration

## **1.6.6 Safety**

UL, CCC, BSMI

## **1.6.7 EMC**

CE, FCC, CCC

# Chapter 2

## Hardware Installation

This chapter introduces external I/O and the installation of ARK-DS306 Hardware.

## 2.1 ARK-DS306 I/O Connectors

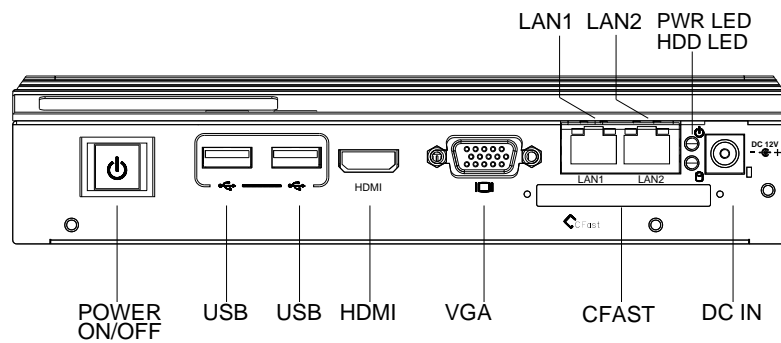

Figure 2.1 ARK-DS306 Front View

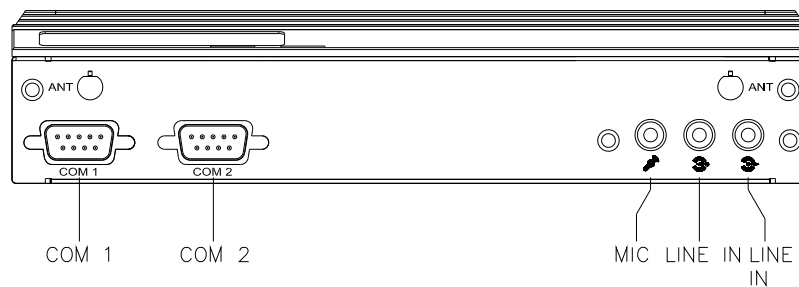

Figure 2.2 ARK-DS306 Rear View

## 2.2 ARK-DS306 Front Side External I/O Connectors

### 2.2.1 Power ON/OFF Button

ARK-DS306 has a power ON/OFF button on front side. Push this button to turn the system ON and OFF.



Figure 2.3 Power ON/OFF Button

### 2.2.2 USB Connectors

The ARK-DS306 provides four USB interface connectors, which gives complete Plug & Play and hot swapping capability for up to 127 external devices. The USB interface is compliant with USB UHCI, Rev. 2.0. The USB interface supports Plug and Play, which enables you to connect or disconnect a device without turning off the computer.

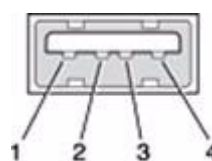

Figure 2.4 USB Port Connector

**Table 2.1: USB Port Pin Assignments**

Pin	Signal Name
1	VCC
2	USB Data-
3	USB Data+
4	GND

### 2.2.3 HDMI Connector

The HDMI (High-Definition Multimedia Interface) provides an all-digital audio/video interface to transmit the uncompressed audio/video signals and is HDCP compliant. Connect the HDMI audio/video device to this port. HDMI technology can support a maximum resolution of 1920x1080P but the actual resolution supported depend on the monitor being used.

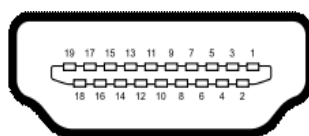
**Figure 2.5 HDMI Connector****Table 2.2: HDMI Connector Pin Assignments**

Pin	Signal Name
1	TMDS Data2+
2	GND
3	TMDS Data2-
4	TMDS Data1+
5	GND
6	TMDS Data1-
7	TMDS Data0+
8	GND
9	TMDS Data0-
10	TMDS Clock+
11	GND
12	TMDS Clock-
13	NC
14	NC
15	SCL
16	SDA
17	GND
18	+5 V Power
19	Detect

## 2.2.4 VGA Connector

The ARK-DS306 provides a high resolution VGA interface connected by a D-SUB 15-pin connector to support VGA CRT compatible monitors.

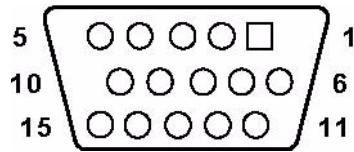

Figure 2.6 VGA Connector

Table 2.3: VGA Connector Pin Assignments

Pin	Signal Name
1	RED
2	GREEN
3	BLUE
4	NC
5	GND
6	GND
7	GND
8	GND
9	+V5
10	GND
11	NC
12	DDC DAT
13	H-SYNC
14	V-SYNC
15	DDC CLK

## 2.2.5 LAN Connectors

The ARK-DS306 provides two RJ45 LAN interface connector, they are fully compliant with IEEE 802.3u 10/100/1000 Base-T CSMA/CD standards. The Ethernet port provides a standard RJ45 jack connector with LED indicators on the front side to show its Active/Link status and speed status.

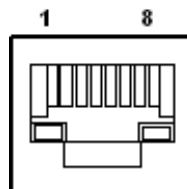

Figure 2.7 Ethernet Connector

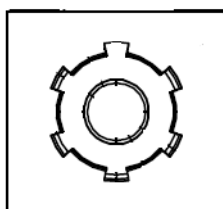

**Table 2.4: LAN Connector Pin Assignments**

Pin	Signal Name
1	MDI0+
2	MDI0-
3	MDI1+
4	MDI1-
5	GND
6	GND
7	MDI2+
8	MDI2-
9	MDI3+
10	MDI3-
11	VCC
12	ACT
13	Link100#
14	Link1000#

### 2.2.6 DC Input connector

The ARK-DS306 comes with a DC-jack header that takes 12 V<sub>DC</sub> external power input.



**Figure 2.8 Power Input Connector**

## 2.3 ARK-DS306 Rear Side External I/O Connectors

### 2.3.1 COM Connectors

The ARK-DS306 provides two D-SUB 9-pin connector serial communication interface port. The port support RS-232 mode communication.

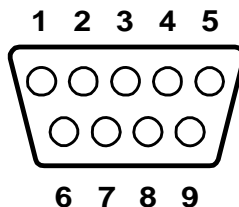

Figure 2.9 COM connector

Table 2.5: COM Port Pin Assignments

Pin	Signal Name
1	DCD
2	RxD
3	TxD
4	DTR
5	GND
6	DSR
7	RTS
8	CTS
9	RI

### 2.3.2 Audio Connector

The ARK-DS306 offers stereo audio ports by three phone jack connectors of Speaker out, Line In, Mic-In, the audio chip control vendor by Realtek, it's compliant with Azalia standard, the Speaker Out support 3D surround stereo sound.

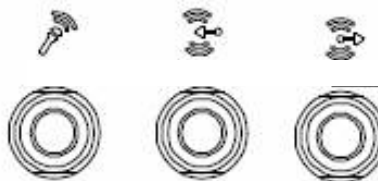

Figure 2.10 MIC, Line-in and Line-out Connector

## 2.4 HW Installation

### 2.4.1 Memory & HDD Installation

1. Remove the Top heatsink cover by loosening the fixing screws then insert memory into the SO-DIMM socket.
2. Remove the bottom cover by loosening the fixing screws, fix the HDD with screws and connect SATA cables to the HDD.

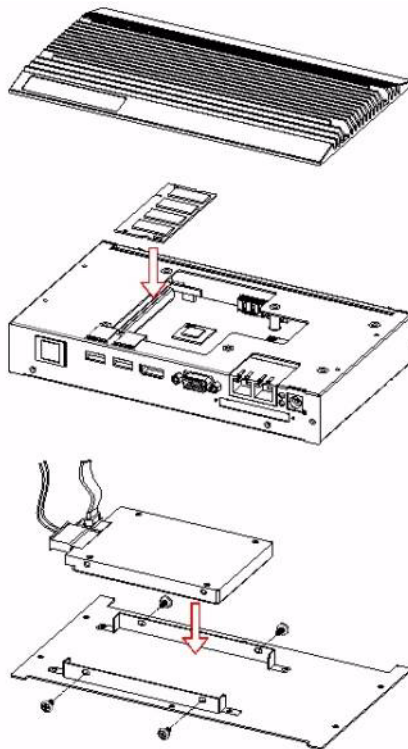

Figure 2.11 Memory & HDD Installation

## 2.4.2 CFast Card Installation

1. Loosening the fixing screws and taking out of the CFast bracket.
2. Install CFast card on the CFast bracket.
3. Insert the bracket with CFast card to the system and fix the screws.

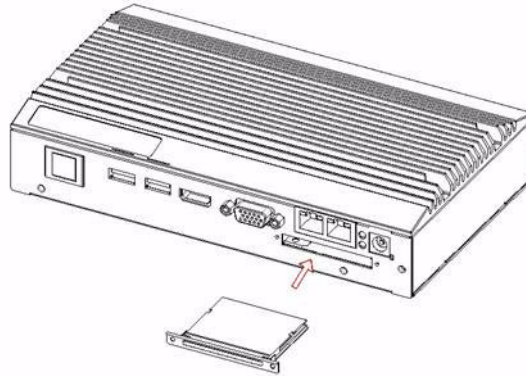

Figure 2.12 CFast card Installation

## 2.4.3 Mini PCIe WLAN Installation

1. Remove the bottom cover by loosening the fixing screws then insert Mini PCIe WLAN module into the socket.
2. Install the WLAN cable and antenna.

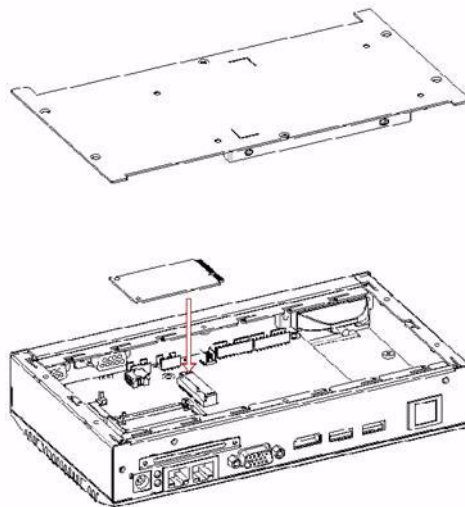

Figure 2.13 Mini PCIe WLAN Installation

# Chapter 3

## BIOS Settings

## 3.1 Introduction

AMIBIOS has been integrated into many motherboards for over a decade. With the AMIBIOS Setup program, you can modify BIOS settings and control the various system features. This chapter describes the basic navigation of the ARK-DS306 BIOS setup screens.

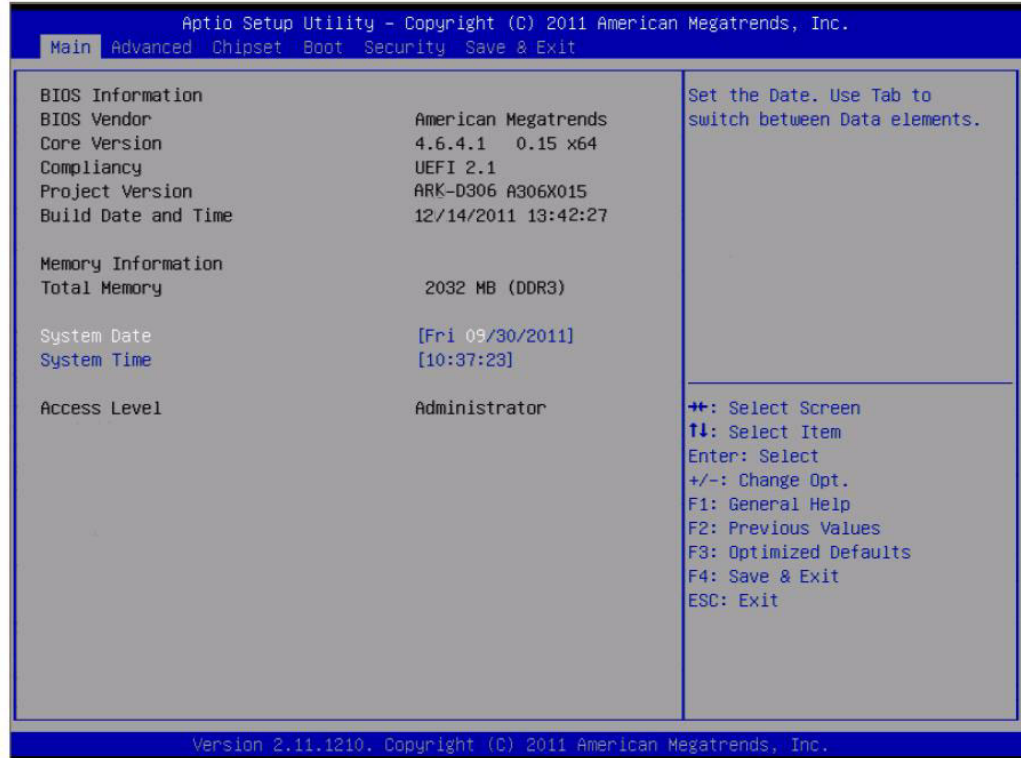

AMI's BIOS ROM has a built-in Setup program that allows users to modify the basic system configuration. This information is stored in battery-backed CMOS so it retains the Setup information when the power is turned off.

## 3.2 Entering Setup

Turn on the computer and check for the “patch” code. If there is a number assigned to the patch code, it means that the BIOS supports your CPU. If there is no number assigned to the patch code, please contact an Advantech application engineer to obtain an up-to-date patch code file. This will ensure that your CPU’s system status is valid. After ensuring that you have a number assigned to the patch code, press <DEL> and you will immediately be allowed to enter Setup.

### 3.2.1 Main Setup

When you first enter the BIOS Setup Utility, you will enter the Main setup screen. You can always return to the Main setup screen by selecting the Main tab. There are two Main Setup options. They are described in this section. The Main BIOS Setup screen is shown below.



The Main BIOS setup screen has two main frames. The left frame displays all the options that can be configured. Grayed-out options cannot be configured; options in blue can. The right frame displays the key legend.

Above the key legend is an area reserved for a text message. When an option is selected in the left frame, it is highlighted in white. Often a text message will accompany it.

#### ■ System date / System time

Use this option to change the system time and date. Highlight System Time or System Date using the <Arrow> keys. Enter new values through the keyboard. Press the <Tab> key or the <Arrow> keys to move between fields. The date must be entered in MM/DD/YY format. The time must be entered in HH:MM:SS format.

### 3.2.2 Advanced BIOS Features Setup

Select the Advanced tab from the ARK-DS306 setup screen to enter the Advanced BIOS Setup screen. You can select any of the items in the left frame of the screen, such as CPU Configuration, to go to the sub menu for that item. You can display an Advanced BIOS Setup option by highlighting it using the <Arrow> keys. All Advanced BIOS Setup options are described in this section. The Advanced BIOS Setup screens is shown below. The sub menus are described on the following pages.

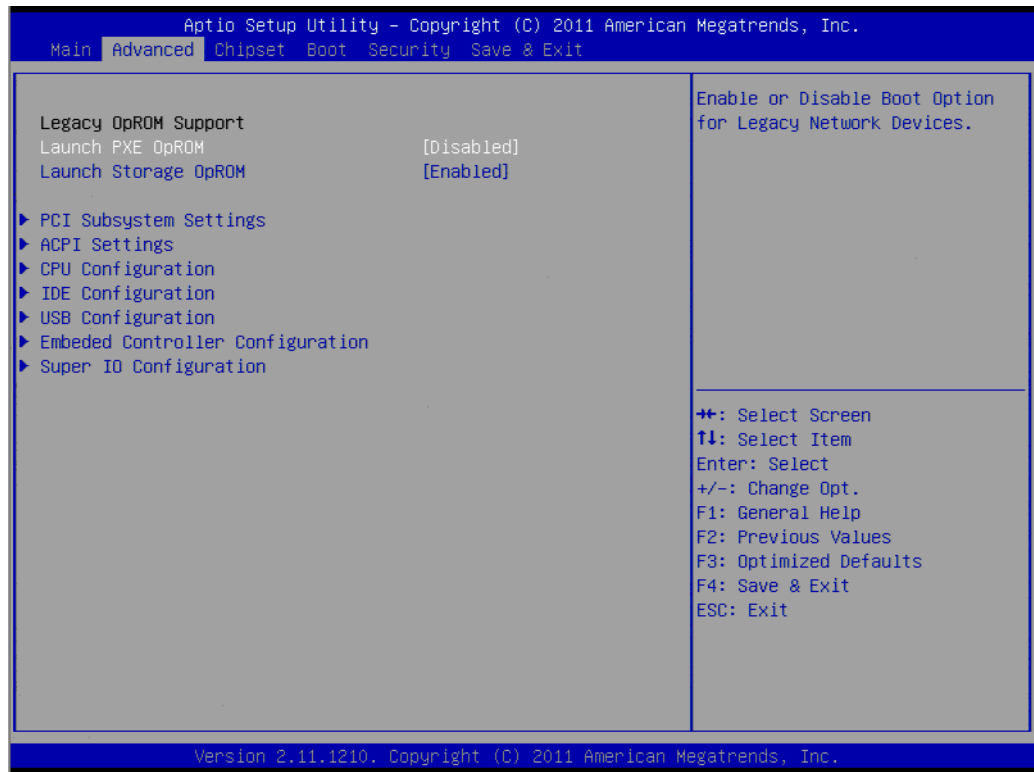

- **Launch PXE OpROM**  
Enable or disable boot option for legacy network devices.
- **Launch Storage OpROM**  
Enable or disable boot option for legacy mass storage with option ROM.



### 3.2.2.1 PCI Subsystem Settings Configuration

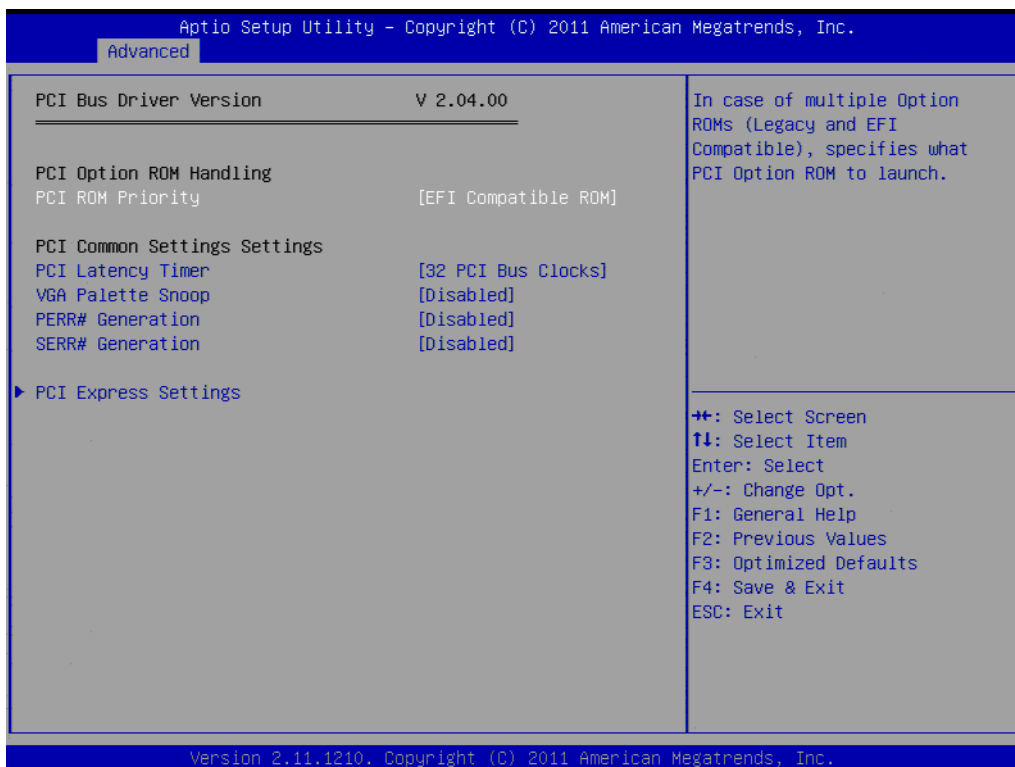

- **PCI ROM Priority**  
This item allows you to select the EFI ROM and Legacy ROM priority.
- **PCI Latency Timer**  
This item allows you to select the 32/64/96/128/160/192/224/248 PCI bus clocks.
- **VGA Palette Snoop**  
Enabled or disable VGA palette registers snooping.
- **PERR# Generation**  
Enabled or disable PCI device to generation PERR#.
- **SERR# Generation**  
Enabled or disable PCI device to generation SERR#.
- **PCI Express Settings**  
Change PCI express device detail settings.

### 3.2.2.2 ACPI Settings Configuration

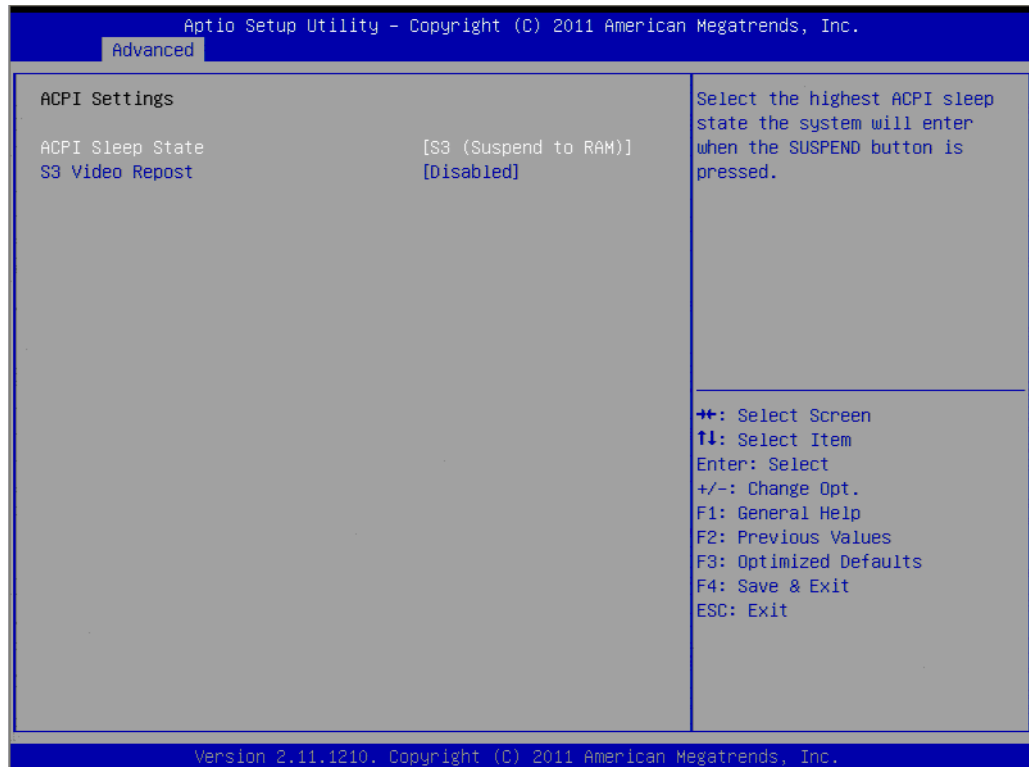

- **ACPI Sleep State**  
Select the ACPI state used for system suspend.
- **S3 Video Repost**  
Enable or disable video repost.

### 3.2.2.3 CPU Configuration



- **Limit CPUID Maximum**  
This item allows you to disabled for Windows XP.
- **PPS Support**  
This item allows you to enable or disable the ACPI \_PPC, \_PSS, and \_PCT objects.
- **PSTATE Adjustment**  
This item allows you to provide P-state level.
- **PPC Adjustment**  
This item allows you to provide \_PPC object.
- **NX Mode**  
This item allows you to enable or disable the No-execute page protection function.
- **SVM Mode**  
This item allows you to enable or disable the CPU virtualization.
- **C6 Mode**  
This item allows you to auto or disable C6 function.
- **Cpb Mode**  
This item allows you to auto or disable CPB.
- **Node 0 Information**  
View detail of memory information related to node 0.

#### 3.2.2.4 IDE Configuration

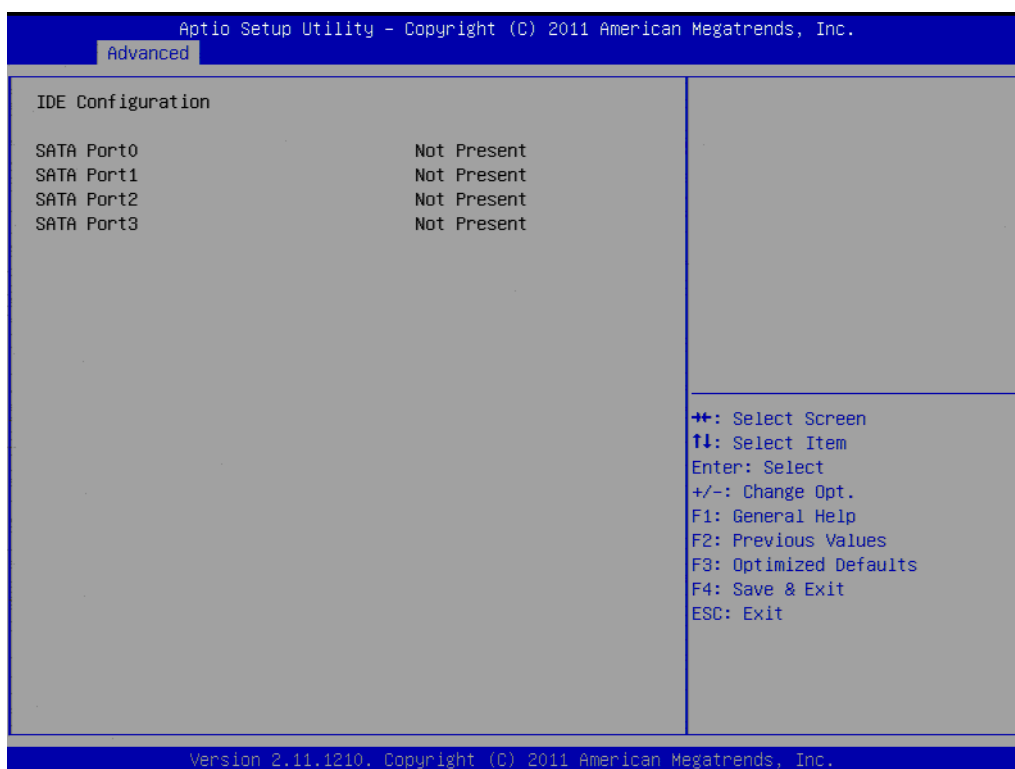

- **IDE Configuration**  
Display SATA Port0 / SATA Port1 / SATA Port2 / SATA Port3 information.

### 3.2.2.5 USB Configuration

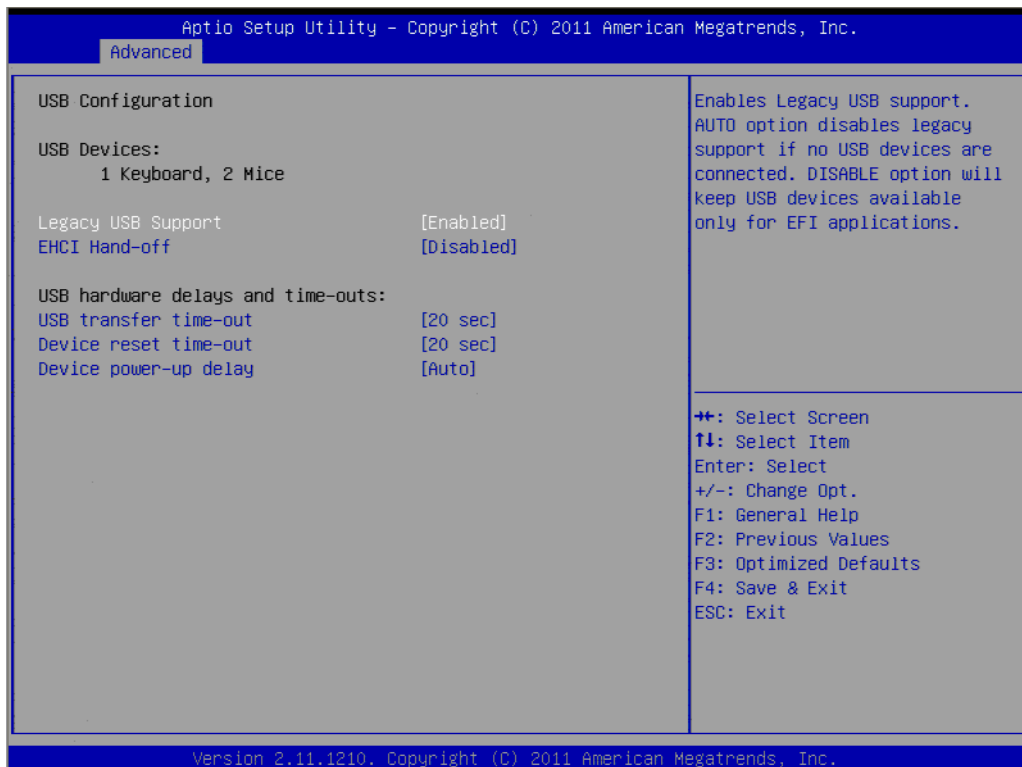

- **Legacy USB Support**  
Enables support for legacy USB. Auto option disables legacy support if no USB devices are connected.
- **EHCI Hand-Off**  
This is a workaround for OSeS without EHCI hand-off support. The EHCI ownership change should claim by EHCI driver.
- **USB transfer time-out**  
Time-out value for control, Bulk, and interrupt transfers.
- **Device reset time-out**  
USB mass storage device start unit command time-out.
- **Device power-up delay**  
Maximum time the device will take before it properly report itself to the host controller.

### 3.2.2.6 Embedded Controller Configuration

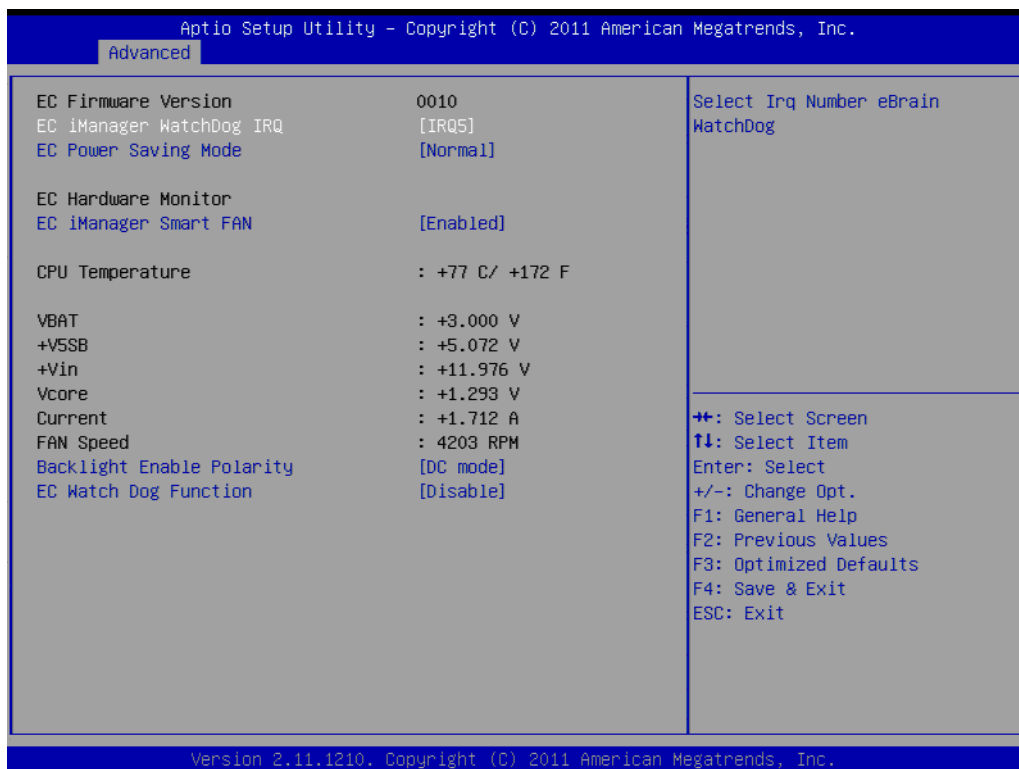

- **EC iManager WatchDog IRQ**  
This item allows you to select IRQ number for watchdog.
- **EC Power Saving Mode**  
This item allows you to select normal or deep sleep power saving.
- **EC iManager Smart FAN**  
This item allows you to enable or disable EC smart FAN control.
- **Temperature & Voltage show**  
CPU Temperature  
VBAT / +V5SB / +Vin / Vcore /
- **Current**  
Display current.
- **Fan Speed show**  
Display Fan Speed RPM.
- **Backlight Enable Polarity**  
This item allows you to select polarity for PWM or DC mode.
- **EC Watch Dog Function**  
This item allows you to select watch dog timer.

### 3.2.2.7 Super I/O Configuration



- **Serial Port1 / Port2 address**  
This item allows you to select serial port1 ~ port2 of base addresses.
- **Serial Port1 / Port2 IRQ**  
This item allows you to select serial port1 ~ port2 of IRQ.
- **Auto Flow Control for Serial Port1**  
This item allows you to enable or disable auto flow control function.

### 3.2.3 Chipset Configuration

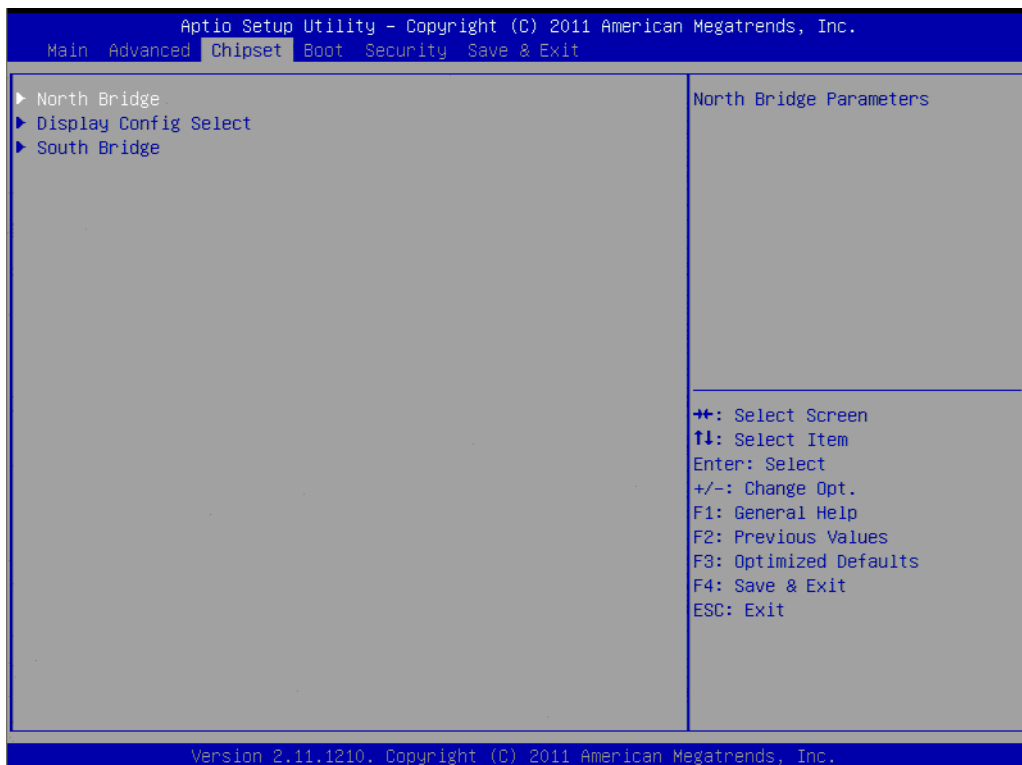

- **North Bridge**  
Detail for North Bridge items.
- **Display Config Select**  
Detail for display items.
- **South Bridge**  
Detail for South Bridge items.

### 3.2.3.1 North Bridge Configuration

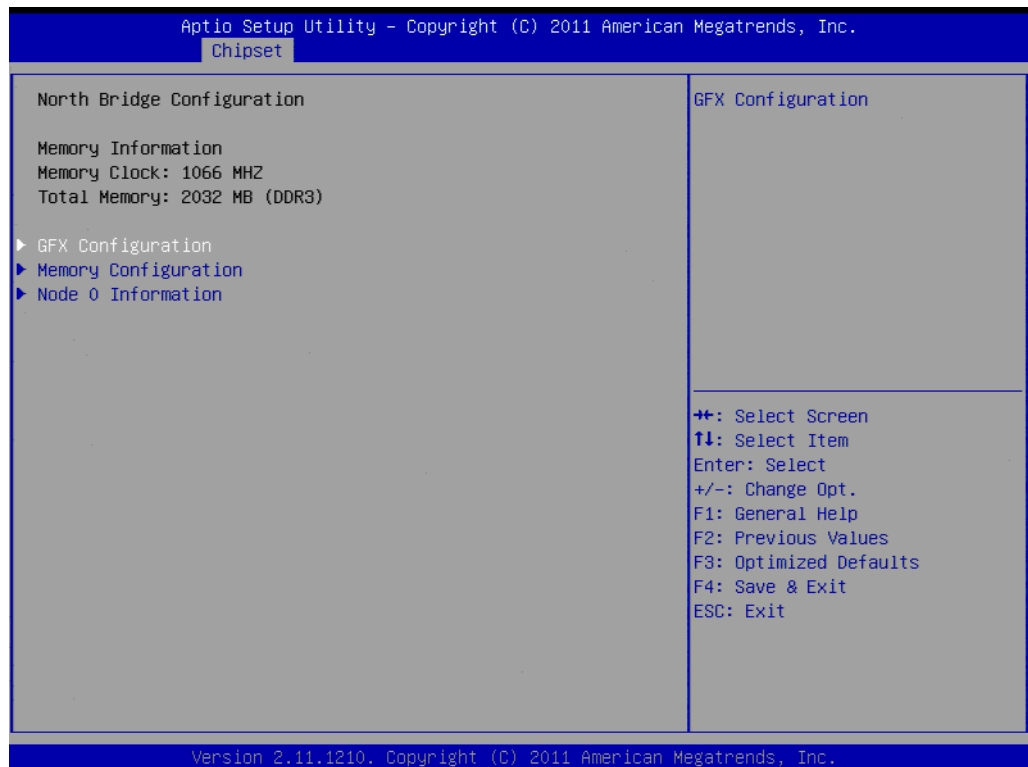

- **GFX Configuration**  
Detail of LAN1/LAN2, and PSPP Policy items.
- **Memory Configuration**  
Detail of Bank Interleaving, IOMMU Mode, and Memory Clock items.
- **Node 0 Information**  
Detail of memory information.



### 3.2.3.2 Display Configuration Select

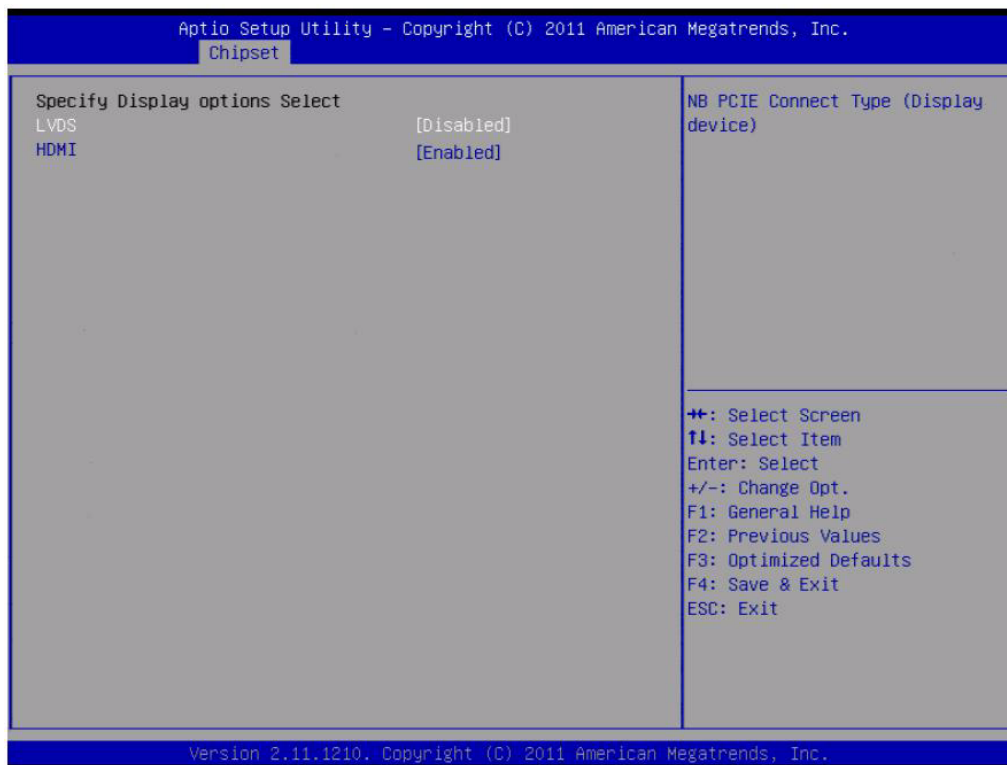

- **HDMI**  
This item allows you to enable or disable HDMI function.

### 3.2.3.3 South Bridge



- **SB SATA Configuration**  
Options for SATA configuration.
- **SB GPP Port Configuration**  
Options for SB GPP port configuration.
- **SB HD Azalia Configuration**  
Options for SB HD Azalia.
- **MINI Card/M-SATA**  
This item allows you to select MINI card or M-SATA.

### 3.2.4 Boot Configuration



- **Setup Prompt Timeout**  
This item allows you to change number of seconds to wait for setup activation key.
- **Bootup NumLock State**  
Select the Power-on state for Numlock.
- **Quiet Boot**  
If this option is set to Disabled, the BIOS displays normal POST messages. If Enabled, an OEM Logo is shown instead of POST messages.
- **Fast Boot**  
This item allows BIOS to skip certain tests while booting. This will decrease the time needed to boot the system.
- **GateA20 Active**  
This item allows you to select Upon request or Always.
- **Option ROM Messages**  
Set display mode for option ROM.
- **Interrupt 19 Capture**  
This item allows option ROMs to trap interrupt 19.
- **Boot Option**  
Sets the system boot order.

## 3.2.5 Security Configuration



Select Security Setup from the ARK-DS306 Setup main BIOS setup menu. All Security Setup options, such as password protection and virus protection are described in this section. To access the sub menu for the following items, select the item and press <Enter>:

### **Change Administrator / User Password**

### 3.2.6 Save & Exit



- **Save Changes and Exit**  
This item allows you to exit system setup after saving the changes.
- **Discard Changes and Exit**  
This item allows you to exit system setup without saving any changes.
- **Save Changes and Reset**  
This item allows you to reset the system after saving the changes.
- **Discard Changes and Reset**  
This item allows you to rest system setup without saving any changes.
- **Save Changes**  
This item allows you to save changes done so far to any of the options.
- **Discard Changes**  
This item allows you to disccard changes done so far to any of the options.
- **Restore Defaults**  
This item allows you to restore/load default values for all the options.
- **Save as User Defaults**  
This item allows you to save the changes done so far as user defaults.
- **Restore User Defaults**  
This item allows you to restore the user defaults to all the options.
- **Boot Override**  
Boot device select can override your boot priority.



# Chapter 4

## Software Installation

This chapter introduces driver installation.

## 4.1 Driver Installation

### 4.1.1 CPU Driver Installation

1. Change folder address. And double click to Setup.exe.

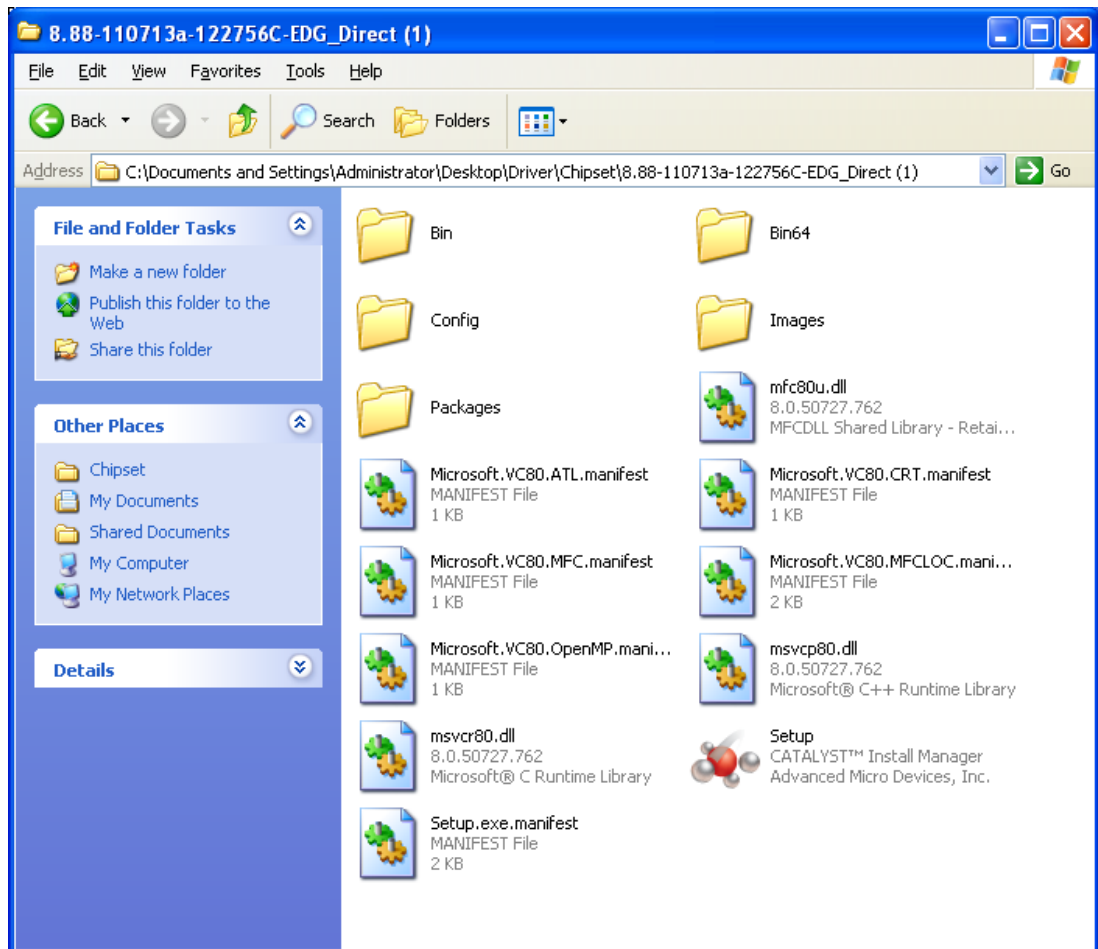



2. Select language and Click "Next" bottom to the next step.

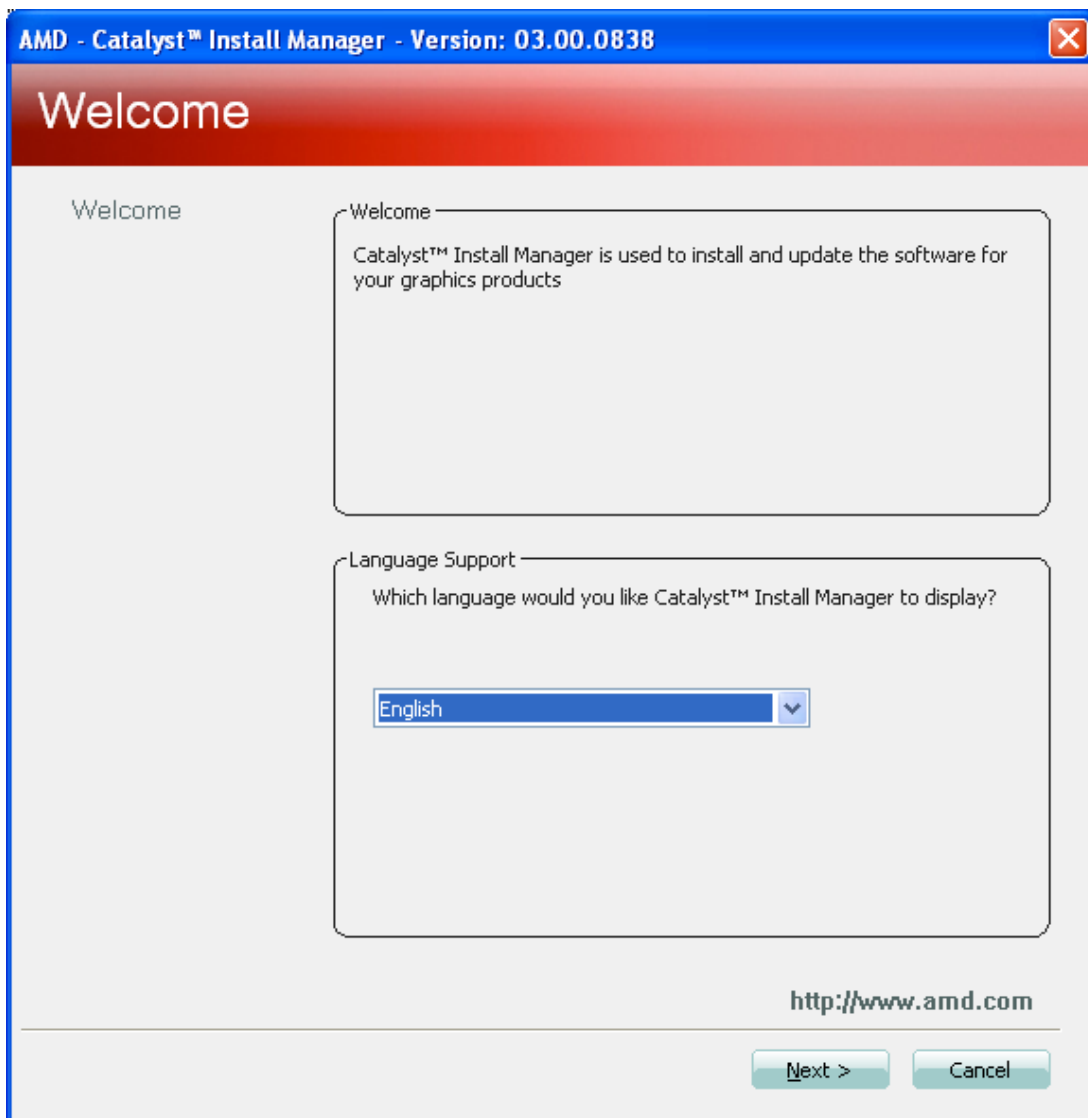

3. Click "Install" button to start Installation.

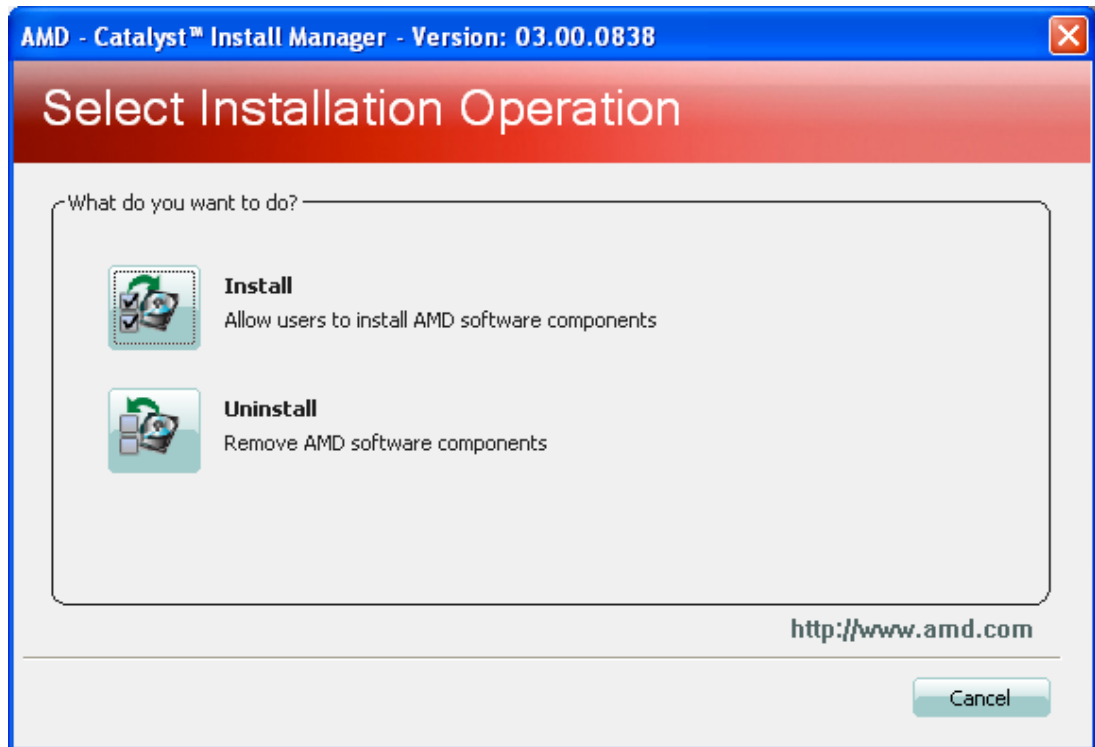

4. Select Express or Custom Install and then click "Next".

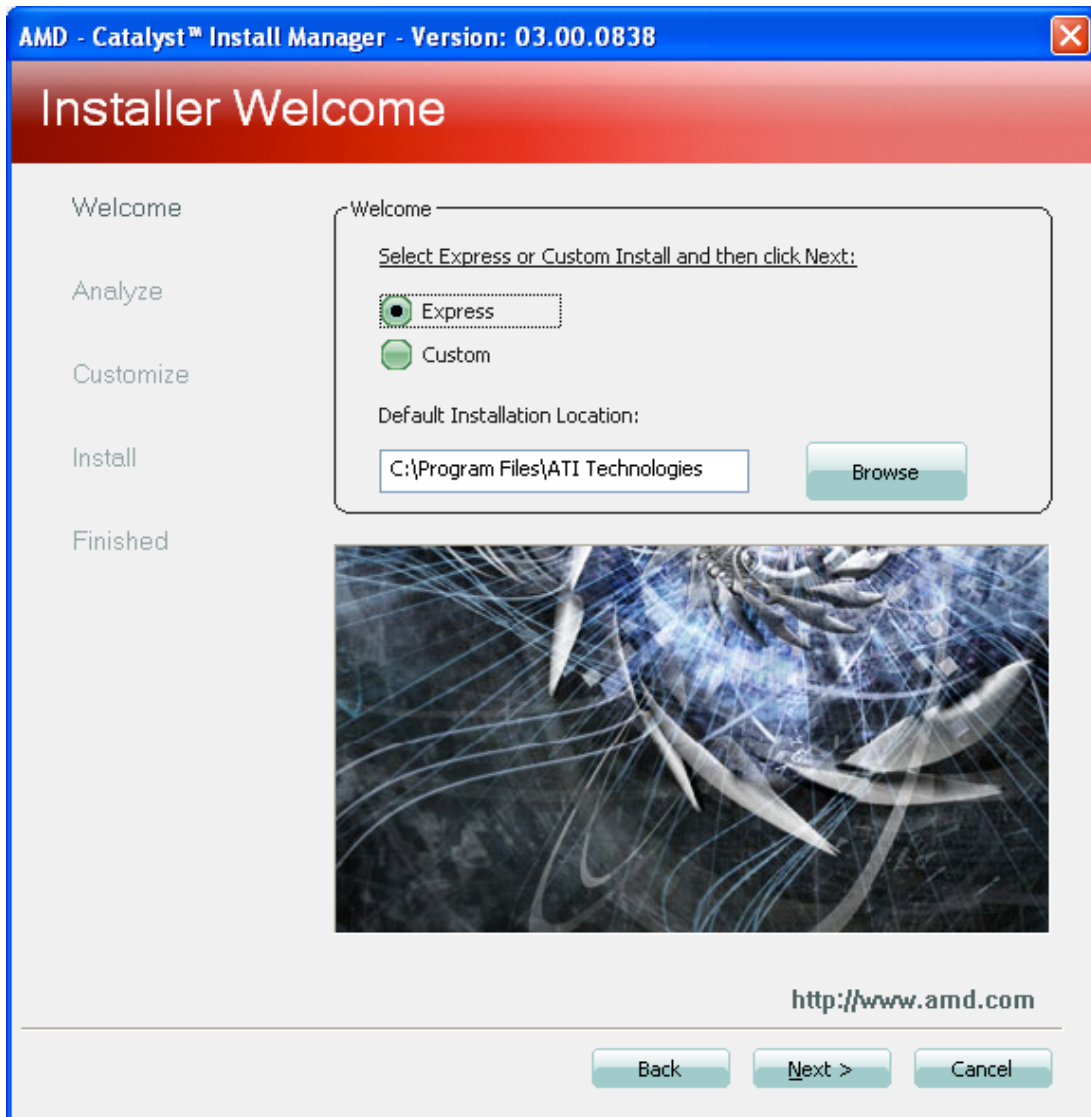

5. Click "Accept" to end user License Agreement.

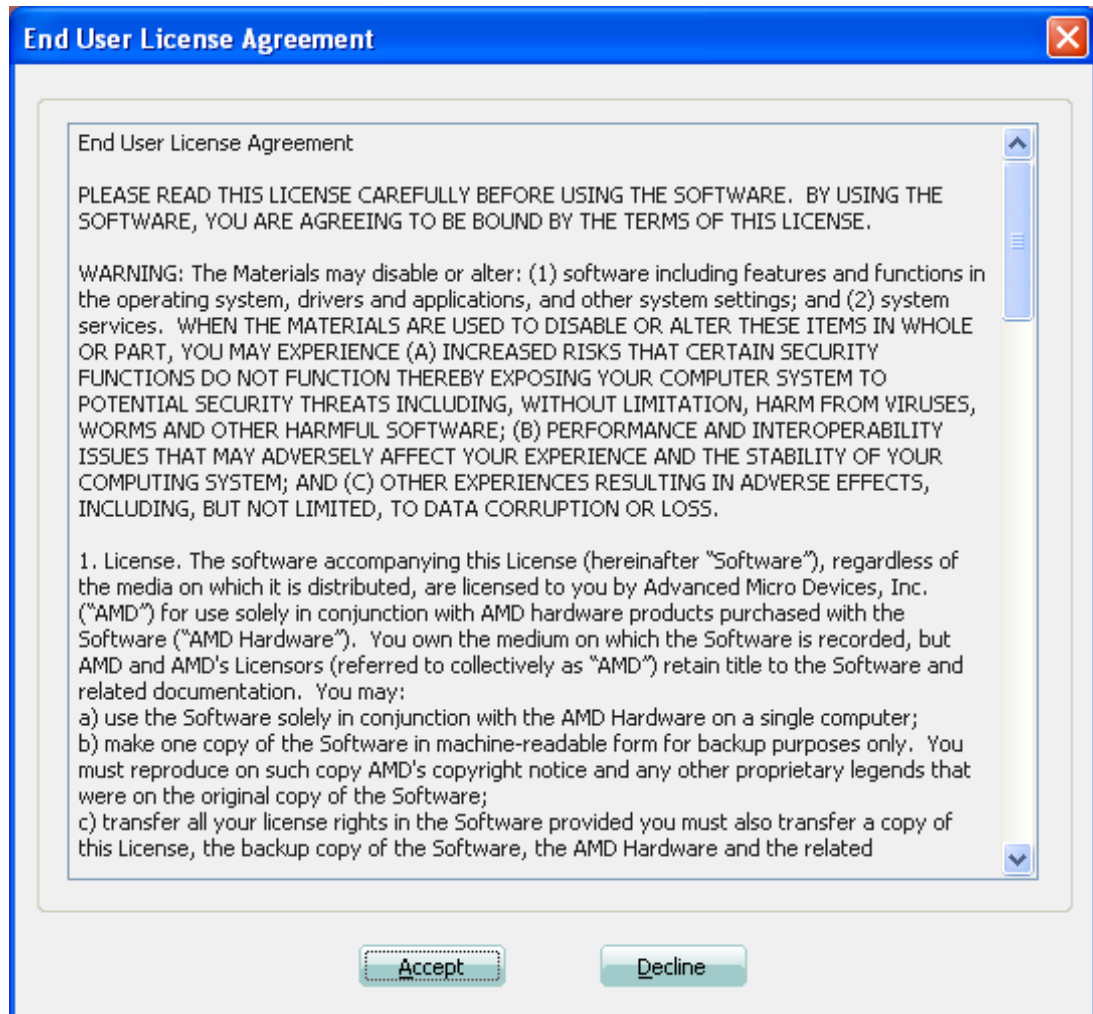

6. If the folder is not exist, Click "Yes" to create this folder.

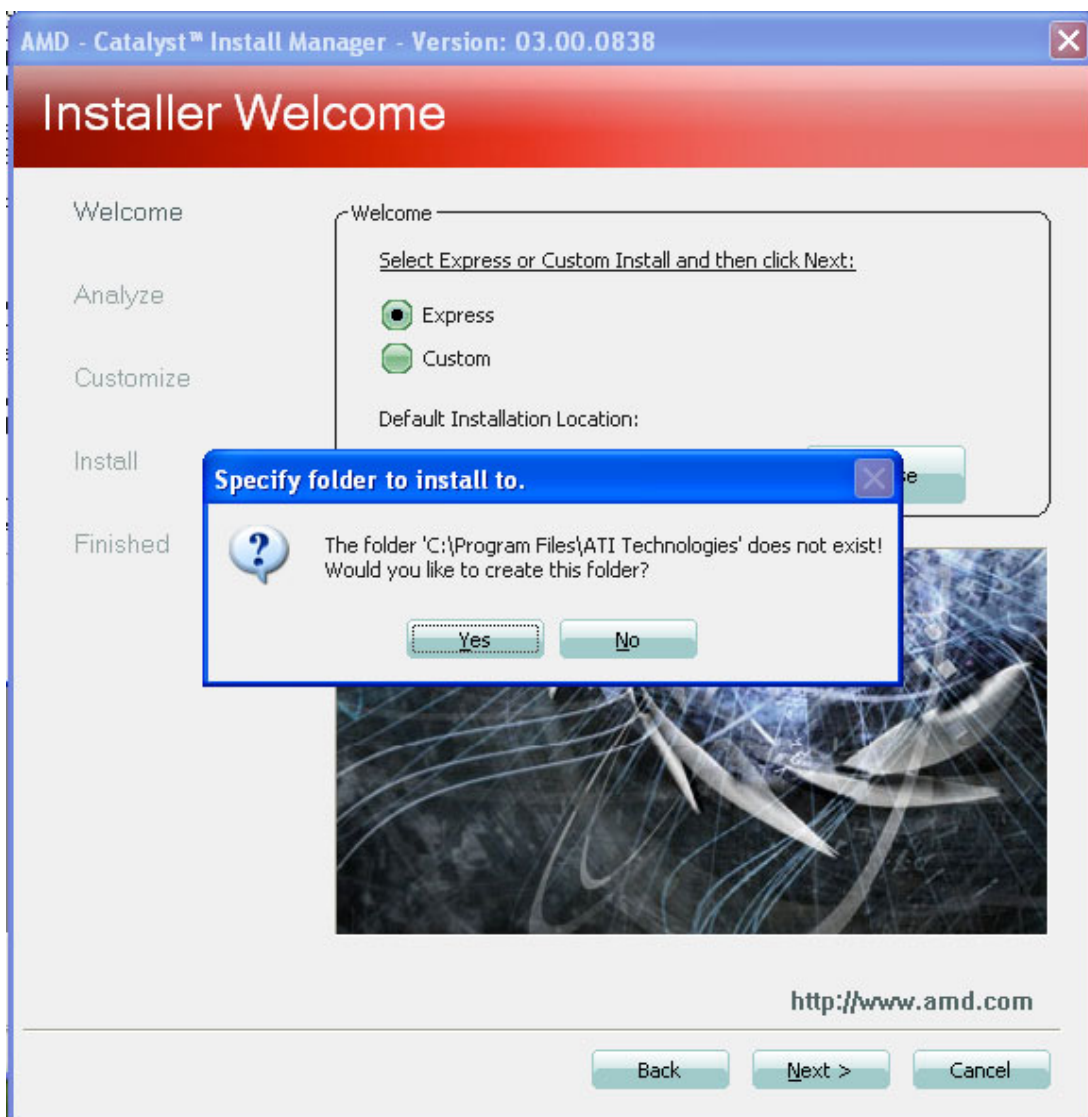

7. Click "Finish" bottom. Then the driver installation is completed.

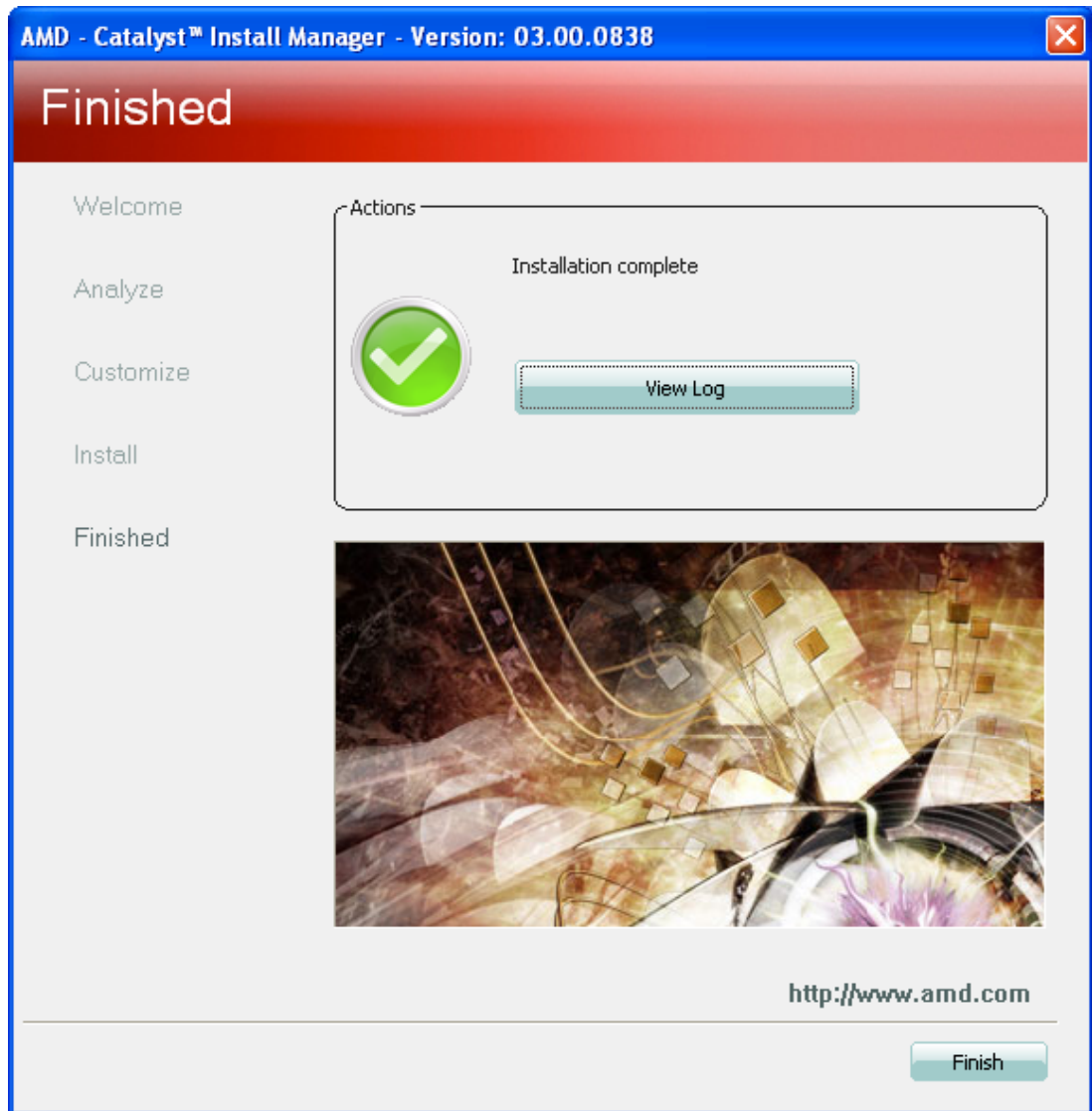

8. Select "Yes". The computer will restart automatically.

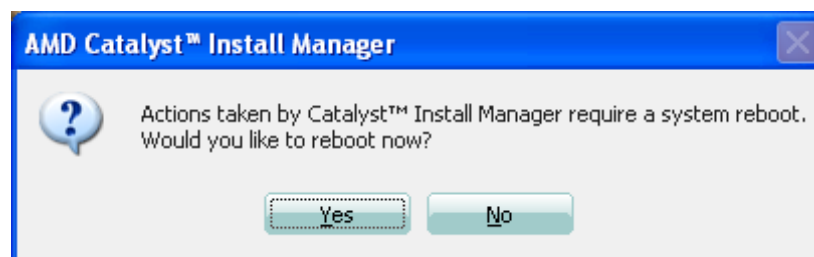

## 4.1.2 LAN Driver Installation

1. Change folder address to \Drivers\LAN. And double click to execute Setup.exe.

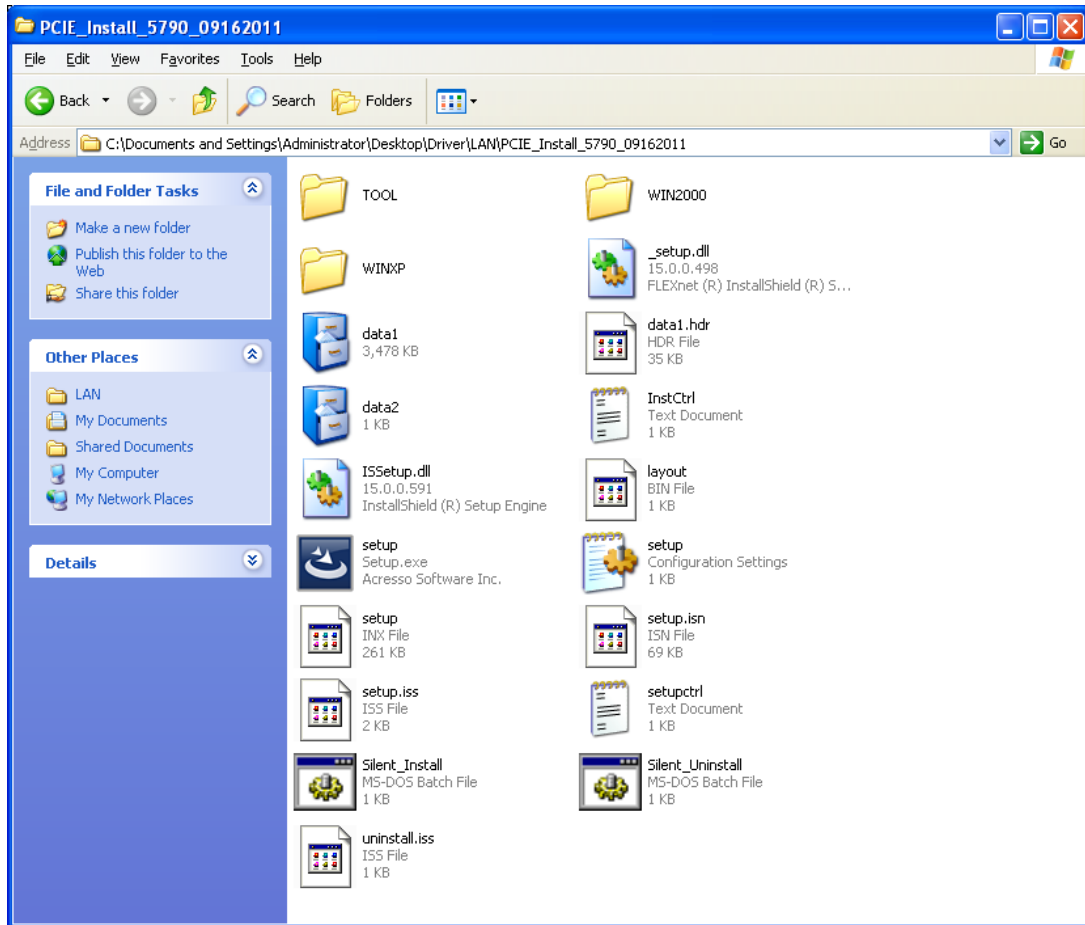

2. Click "Next" button to the next step.

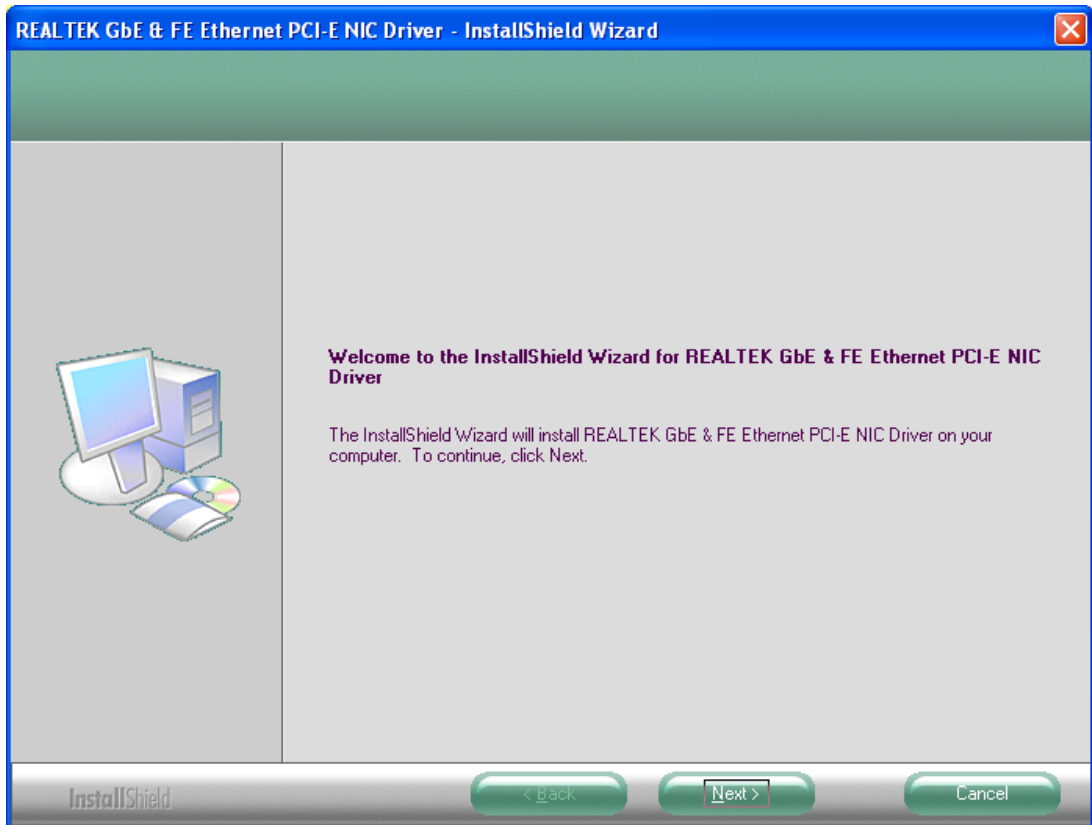

3. Click "Install" button to start Installation.

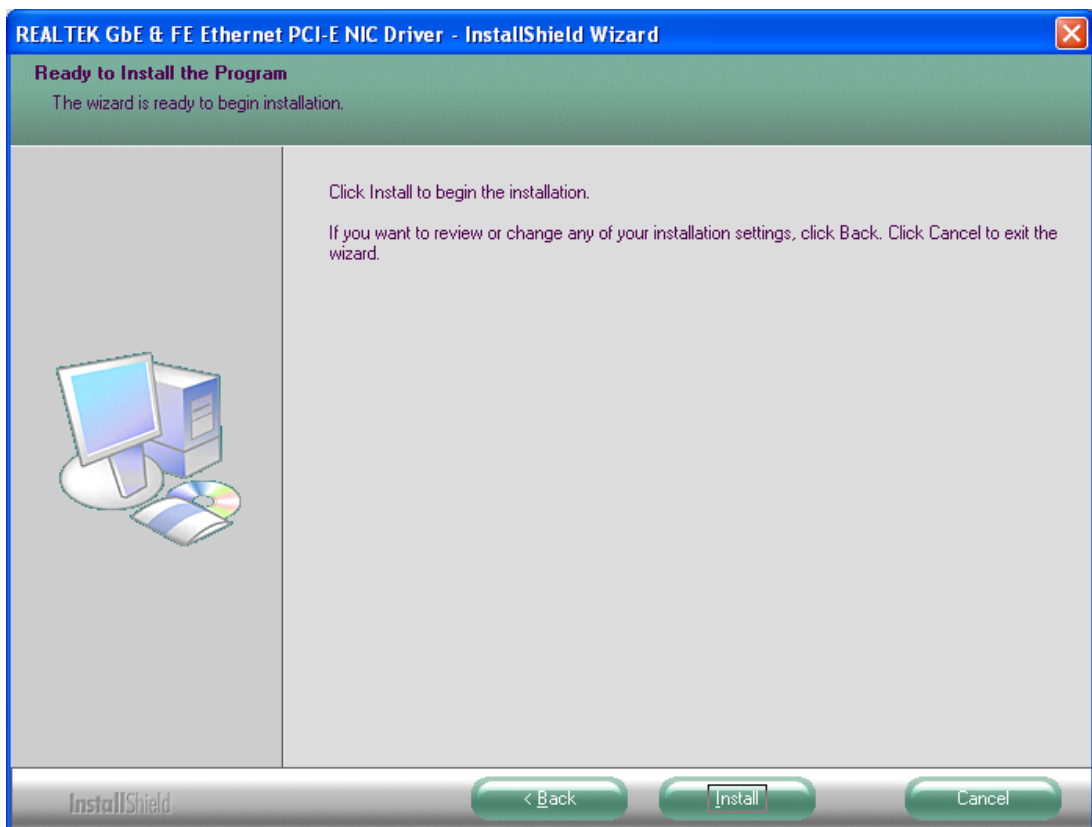



4. The network driver installation is completed. Click "Finish" button to exit InstallShield.

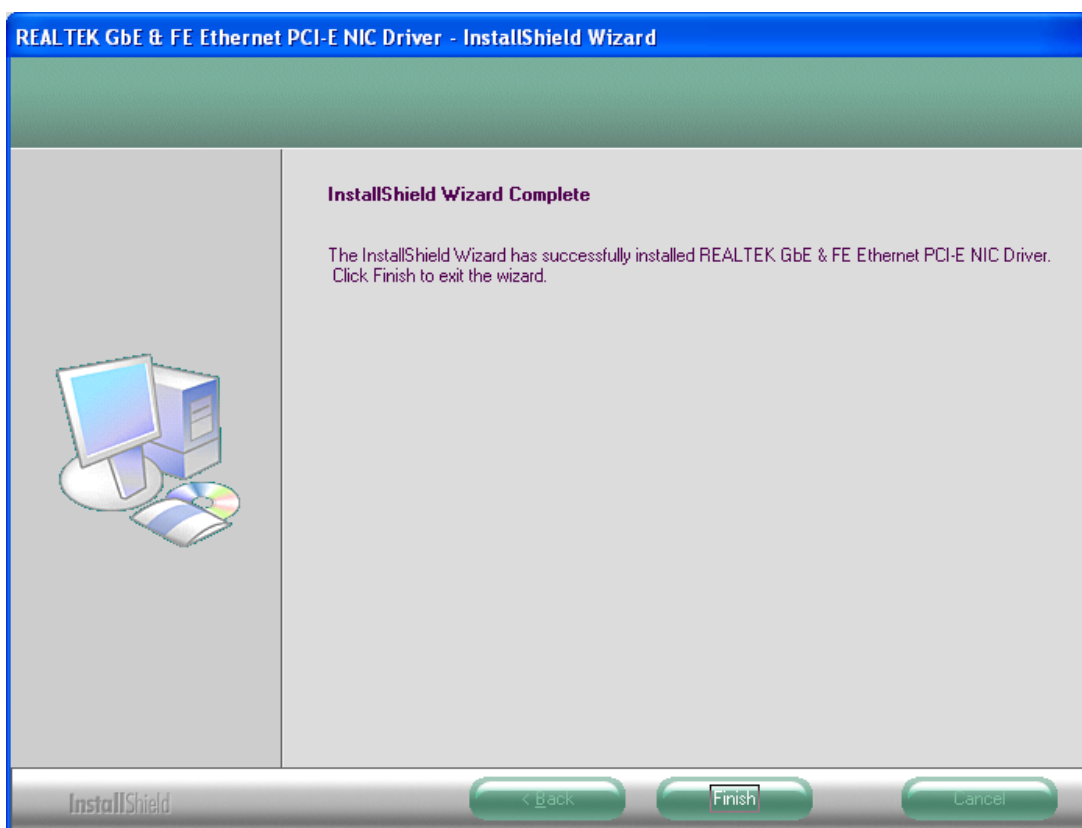

### 4.1.3 Audio Driver Installation

1. Change folder address to \AUDIO. And double click to execute Setup.exe.

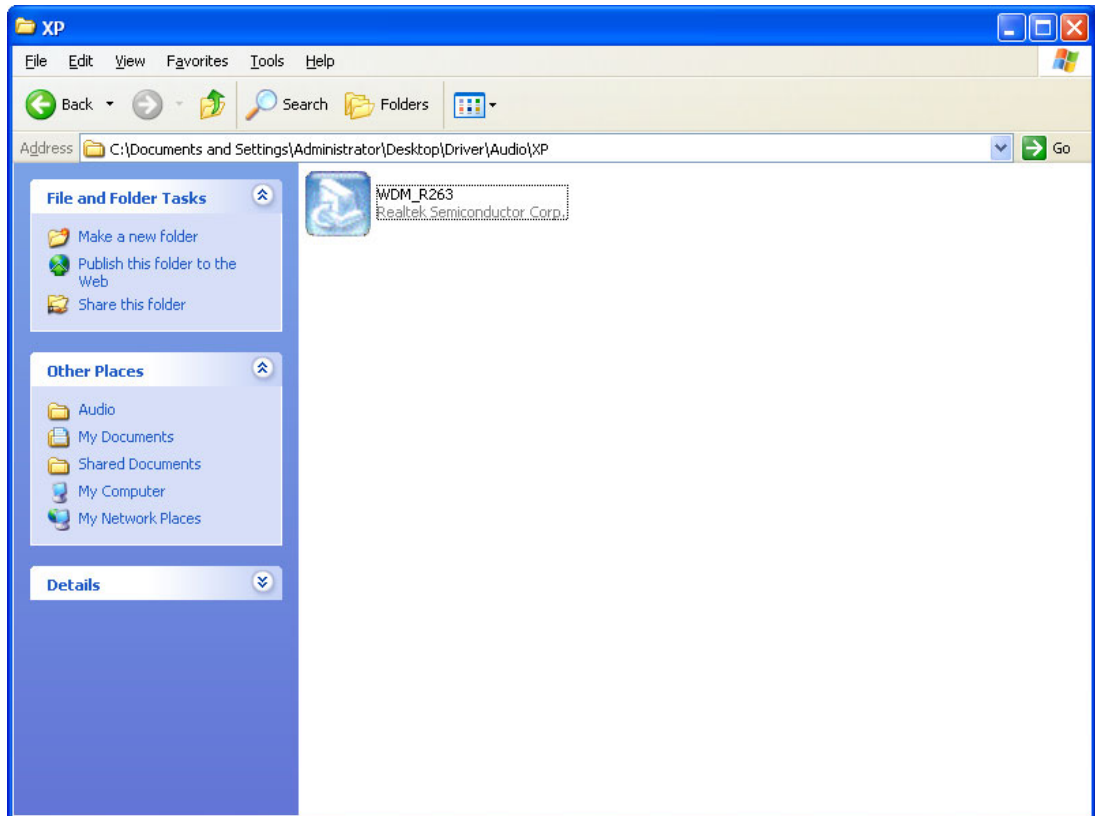

2. Click "Next" button to skip welcome message.

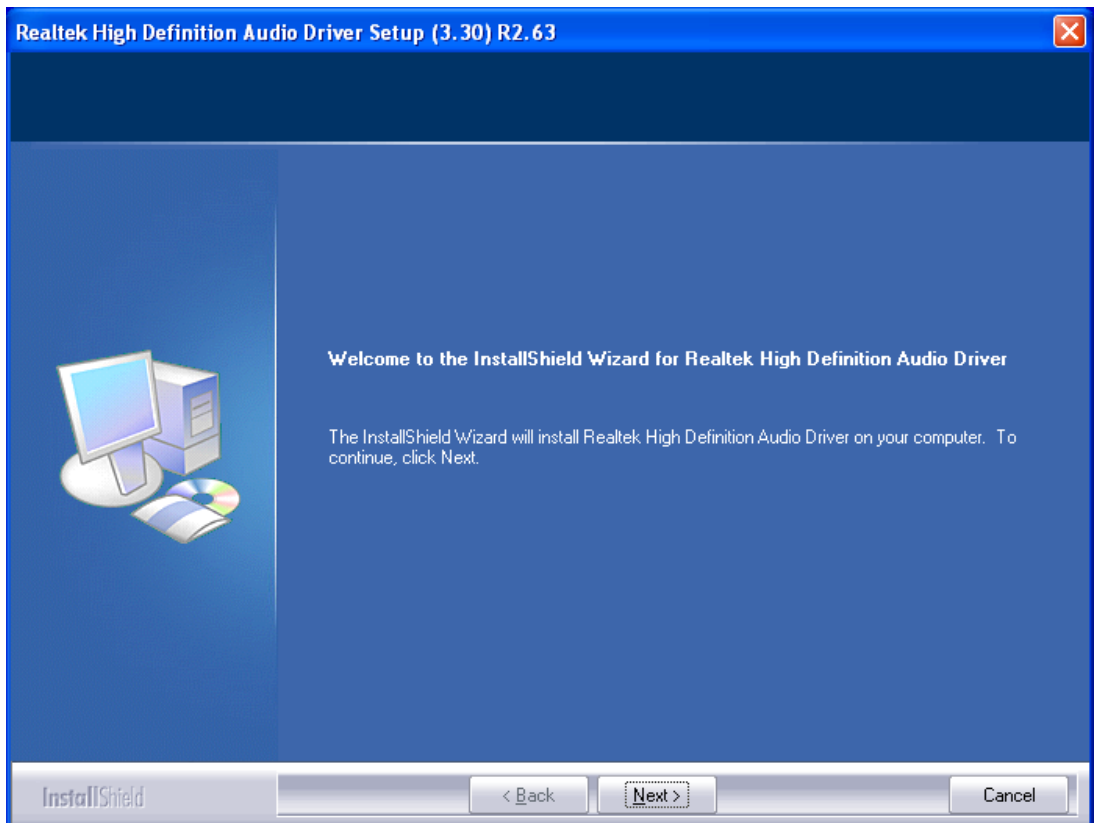

3. Select "Yes, I want to restart this computer now." and click "Finish" bottom. The computer will restart automatically. Then the driver installation is completed.

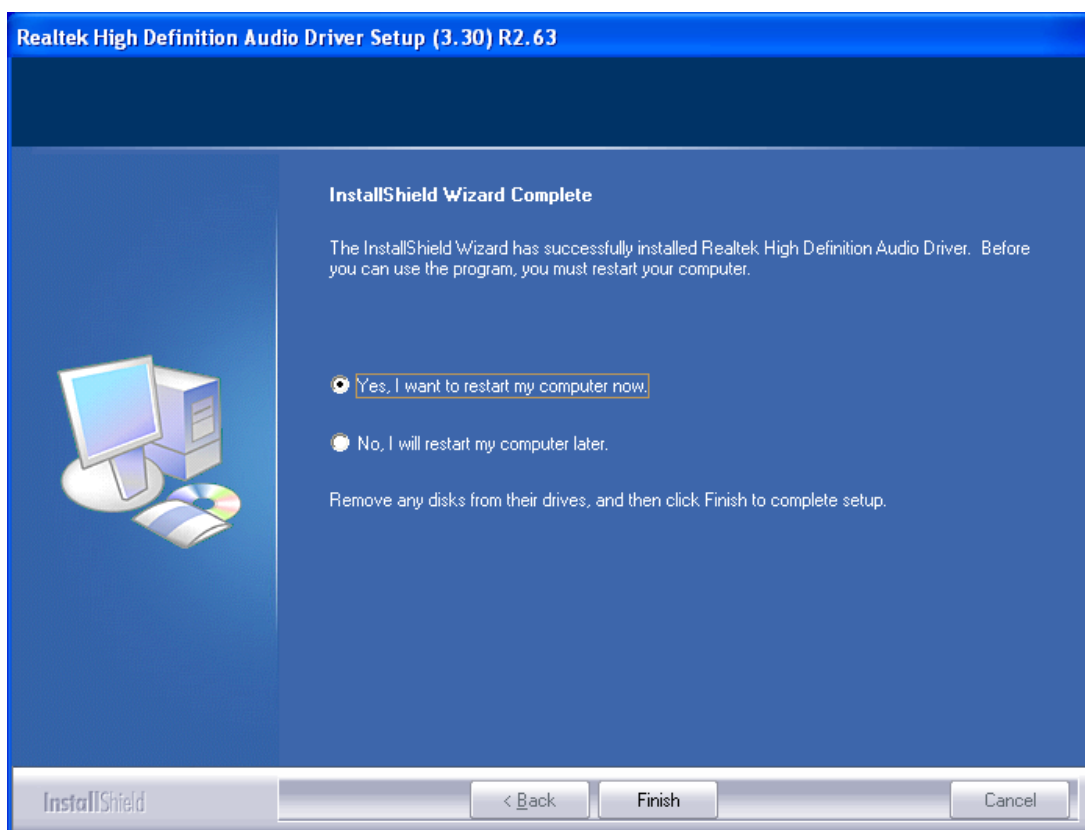



**ADVANTECH**

*Enabling an Intelligent Planet*

**[www.advantech.com](http://www.advantech.com)**

Please verify specifications before quoting. This guide is intended for reference purposes only.

All product specifications are subject to change without notice.

No part of this publication may be reproduced in any form or by any means, electronic, photocopying, recording or otherwise, without prior written permission of the publisher.

All brand and product names are trademarks or registered trademarks of their respective companies.

© Advantech Co., Ltd. 2011