

XLamp® CMA1516 LED



PRODUCT DESCRIPTION

The XLamp® High-Current LED Array family is optimized for best-in-class lumen output, efficacy and reliability at high drive currents. XLamp CMA LEDs share the same package design and LES sizes as Cree LED’s industry-leading CXA2 Standard Density LEDs, enabling lighting manufacturers to address a range of performance requirements for applications such as track, downlight and outdoor lighting using a single easy-to-use platform. XLamp High-Current LED Arrays are available in 2-step, 3-step and 5-step EasyWhite® bins.

FEATURES

- 9-mm optical source
- Mechanical and optical design consistent with CXA15 and CXB15 LEDs
- Available in 70-, 80- and 90- and 95-minimum CRI options
- EasyWhite® 2-, 3- and 5-step binning
- Premium Color 2- and 3-step binning
- Forward voltage option: 36-V class
- 85 °C binning and characterization
- Maximum drive current: 1050 mA
- 115° viewing angle, uniform chromaticity profile
- Top-side solder connections
- RoHS and REACH compliant
- UL® recognized component (E349212)

TABLE OF CONTENTS

Characteristics	2
Operating Limits.....	2
Flux Characteristics, EasyWhite® Order Codes and Bins	3
Flux Characteristics, Premium Color Order Codes and Bins	4
Relative Spectral Power Distribution, EasyWhite® LEDs.....	5
Relative Spectral Power Distribution, Premium Color LEDs.....	6
Electrical Characteristics.....	8
Relative Luminous Flux.....	9
Typical Spatial Distribution.....	9
EasyWhite® Performance Groups - Chromaticity	10
Premium Color Performance Groups - Chromaticity	11
EasyWhite® Bins Plotted on the 1931 CIE Color Space	12
Premium Color Bins Plotted on the 1931 CIE Color Space.....	13
Bin and Order Code Formats	15
Mechanical Dimensions	16
Thermal Design	17
Notes	18
Packaging.....	19



Cree LED / 4400 Silicon Drive / Durham, NC 27703 USA / +1.919.313.5330 / www.cree-led.com

CHARACTERISTICS

Characteristics	Unit	Minimum	Typical	Maximum
Viewing angle (FWHM)	degrees		115	
ESD withstand voltage (JEDEC JS-001-2012)	V		Class 3A	
DC forward current	mA			1050*
Reverse current	mA			0.1
Forward voltage (@ 450 mA, 85 °C)	V		34	38.5

* Refer to the Operating Limits section.

OPERATING LIMITS

The maximum current rating of the CMA1516 depends on the case temperature (Tc) when the LED has reached thermal equilibrium under steady-state operation. The graph shown below assumes that the system design employs good thermal management (thermal interface material and heat sink) and may vary when poor thermal management is employed. Either solder pad shown in the Mechanical Dimensions section on page 16 can be used as the Tc measurement point.

Another important factor in good thermal management is the temperature of the Light Emitting Surface (LES). Cree LED recommends a maximum LES temperature of 140 °C to ensure optimal LED lifetime. Please refer to the Thermal Design section on page 17 for more information on LES temperature measurement.

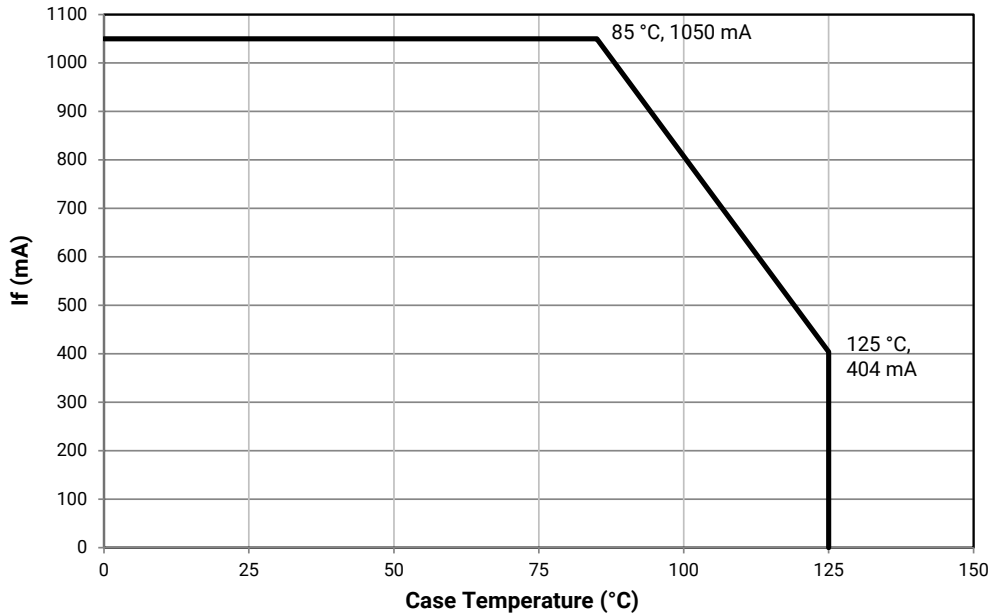

FLUX CHARACTERISTICS, EASYWHITE® ORDER CODES AND BINS ($I_F = 450 \text{ mA}$, $T_J = 85 \text{ °C}$)

The following table provides order codes for XLamp CMA1516 LEDs. For a complete description of the order code nomenclature, please see the Bin and Order Code Formats section (page 15).

Nominal CCT	CRI		Minimum Luminous Flux (lm)	Typical Luminous Flux (lm)	2-Step		3-Step		5-Step	
	Min.	Typ			Group	Order Code	Group	Order Code	Group	Order Code
6500 K	70	73	2306	2480					65E	CMA1516-0000-000N0B0A65E
	80	82	2155	2317					65E	CMA1516-0000-000N0H0A65E
5700 K	70	73	2354	2531					57E	CMA1516-0000-000N0B0A57E
	80	82	2199	2364					57E	CMA1516-0000-000N0H0A57E
	90	92	1870	2011			57G	CMA1516-0000-000N0U0A57G		
5000 K	70	73	2285	2457					50E	CMA1516-0000-000N0B0A50E
	80	82	2135	2296			50G	CMA1516-0000-000N0H0A50G		
	90	92	1870	2011			50G	CMA1516-0000-000N0U0A50G		
4000 K	70	73	2268	2439					40E	CMA1516-0000-000N0B0A40E
	80	82	2111	2270	40H	CMA1516-0000-000N0H0A40H	40G	CMA1516-0000-000N0H0A40G		
	90	92	1817	1954	40H	CMA1516-0000-000N0U0A40H	40G	CMA1516-0000-000N0U0A40G		
3500 K	80	82	2059	2214	35H	CMA1516-0000-000N0H0A35H	35G	CMA1516-0000-000N0H0A35G		
	90	92	1767	1900	35H	CMA1516-0000-000N0U0A35H	35G	CMA1516-0000-000N0U0A35G		
3000 K	70	73	2111	2270					30E	CMA1516-0000-000N0B0A30E
	80	82	2000	2150	30H	CMA1516-0000-000N0H0A30H	30G	CMA1516-0000-000N0H0A30G		
	90	92	1691	1818	30H	CMA1516-0000-000N0U0A30H	30G	CMA1516-0000-000N0U0A30G		
2700 K	80	82	1919	2063	27H	CMA1516-0000-000N0H0A27H	27G	CMA1516-0000-000N0H0A27G		
	90	92	1614	1736	27H	CMA1516-0000-000N0U0A27H	27G	CMA1516-0000-000N0U0A27G		
2200 K	80	82	1691	1818			22G	CMA1516-0000-000N0H0A22G		

- Notes**
- Cree maintains a tolerance of ±7% on flux and power measurements, ±0.005 on chromaticity (CCx, CCy) measurements and a tolerance of ±2 on CRI measurements. See the Measurements section (page 18).
 - For 80 CRI minimum LEDs, CRI R9 minimum is 0 with a ±2 tolerance. For 90 CRI minimum LEDs, CRI R9 typical is 60.

FLUX CHARACTERISTICS, PREMIUM COLOR ORDER CODES AND BINS ($I_f = 450 \text{ mA}$, $T_j = 85 \text{ }^\circ\text{C}$)
Fidelity

Nominal CCT	CRI*		Minimum Luminous Flux (lm)	Typical Luminous Flux (lm)	2-Step	
	Min.	Typ			Group	Order Code
4000 K	95	98	1628	1750	L5A	CMA1516-0000-000N0Z0AL5A
3500 K	95	98	1584	1703	35H	CMA1516-0000-000N0Z0A35H
3000 K	95	98	1481	1593	30H	CMA1516-0000-000N0Z0A30H
2700 K	95	98	1402	1508	27H	CMA1516-0000-000N0Z0A27H

Specialty

Nominal CCT	CRI		Minimum Luminous Flux (lm)	Typical Luminous Flux (lm)	2-Step		3-Step			
	Min.	Typ			Group	Order Code	Group	Order Code	Group	Order Code
3100 K	90	92	1691	1818			31Q	CMA1516-0000-000N0U0A31Q		
3000 K	80	82	2000	2150	L7B	CMA1516-0000-000N0H0AL7B				
	90	92	1691	1818			30Q	CMA1516-0000-000N0U0A30Q	30U	CMA1516-0000-000N0U0A30U
	95	98	1481	1593	L7C	CMA1516-0000-000N0Z0AL7C				

Notes

- Cree maintains a tolerance of $\pm 7\%$ on flux and power measurements, ± 0.005 on chromaticity (CCx, CCy) measurements and a tolerance of ± 2 on CRI measurements. See the Measurements section (page 18).
- For 80 CRI minimum LEDs, CRI R9 minimum is 0 with a ± 2 tolerance. For 90 CRI minimum LEDs, CRI R9 typical is 60.

RELATIVE SPECTRAL POWER DISTRIBUTION, EASYWHITE® LEDS

The following graphs are the result of a series of pulsed measurements at 450 mA and $T_j = 85\text{ }^\circ\text{C}$.

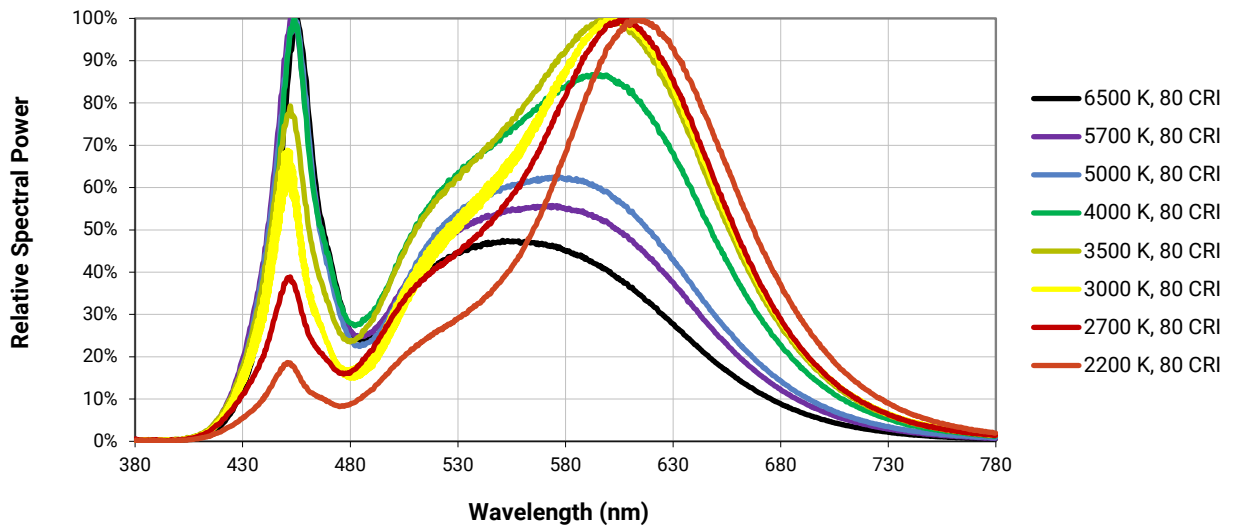
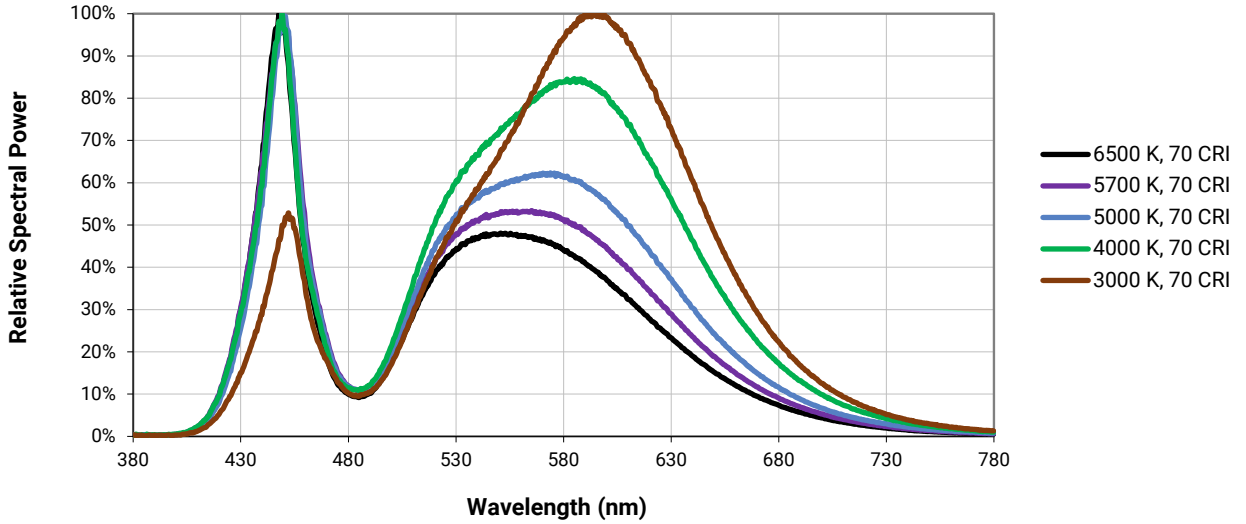

RELATIVE SPECTRAL POWER DISTRIBUTION, EASYWHITE® LEDs - CONTINUED

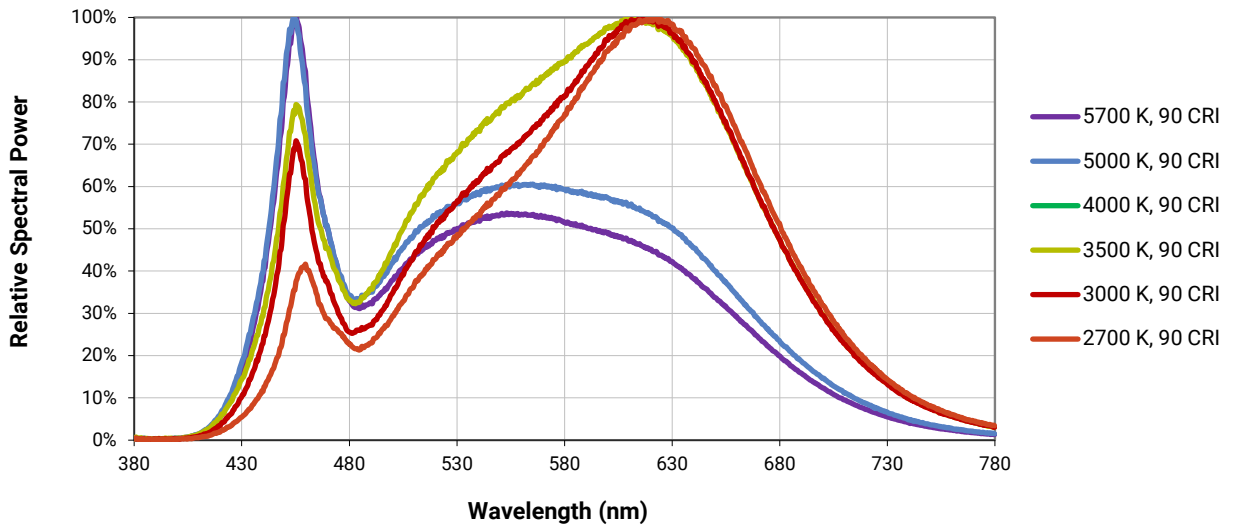

RELATIVE SPECTRAL POWER DISTRIBUTION, PREMIUM COLOR LEDs

The following graphs are the result of a series of pulsed measurements at 450 mA and $T_j = 85^\circ\text{C}$.

Fidelity

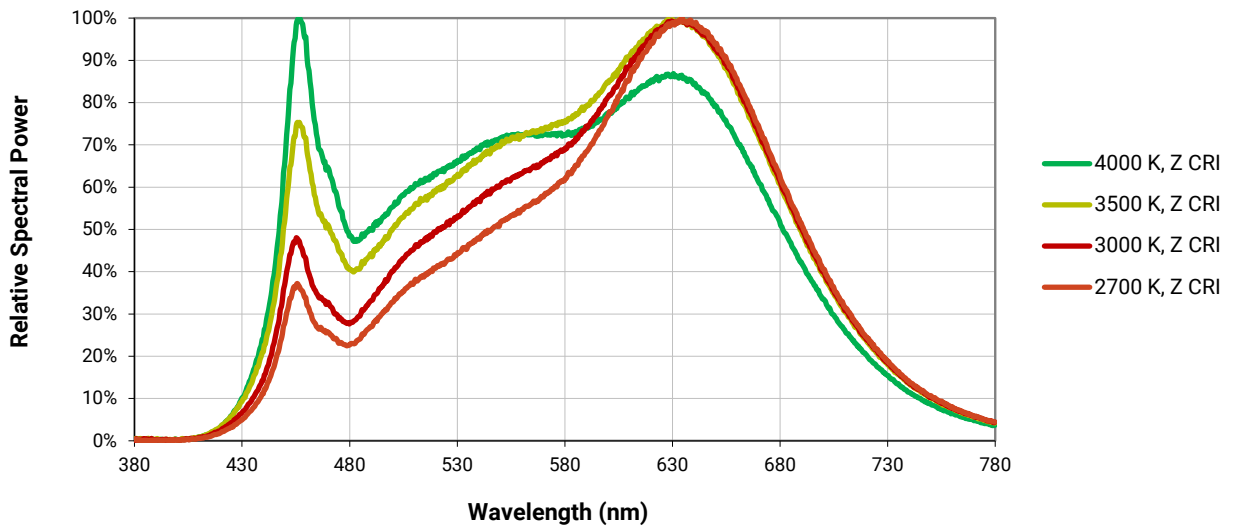

RELATIVE SPECTRAL POWER DISTRIBUTION, PREMIUM COLOR LEDS - CONTINUED

Specialty

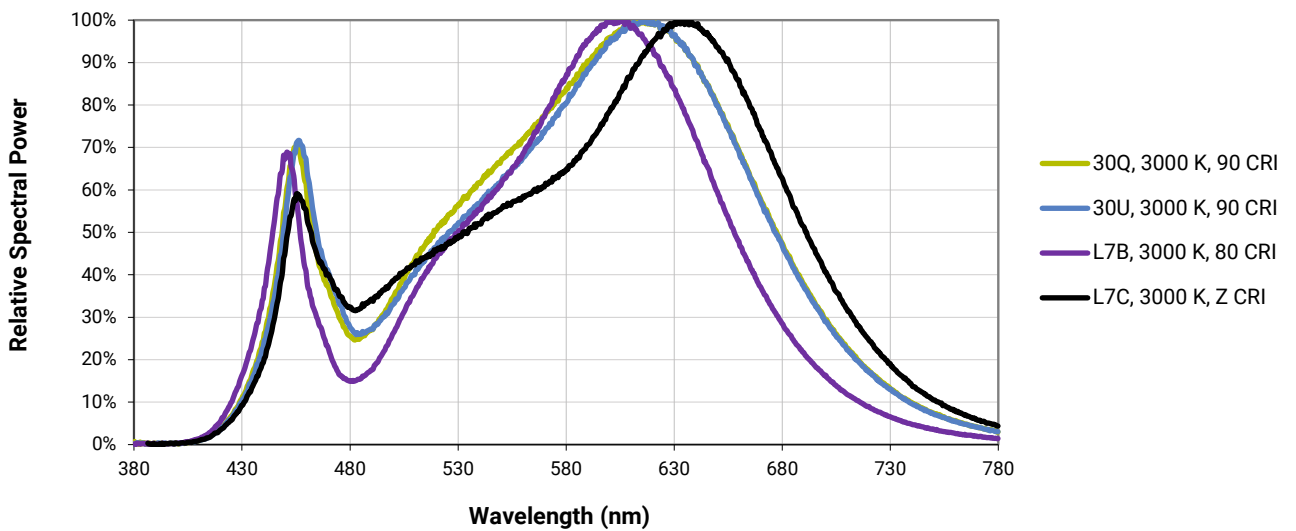

ELECTRICAL CHARACTERISTICS

The following graph is the result of a series of steady-state measurements.

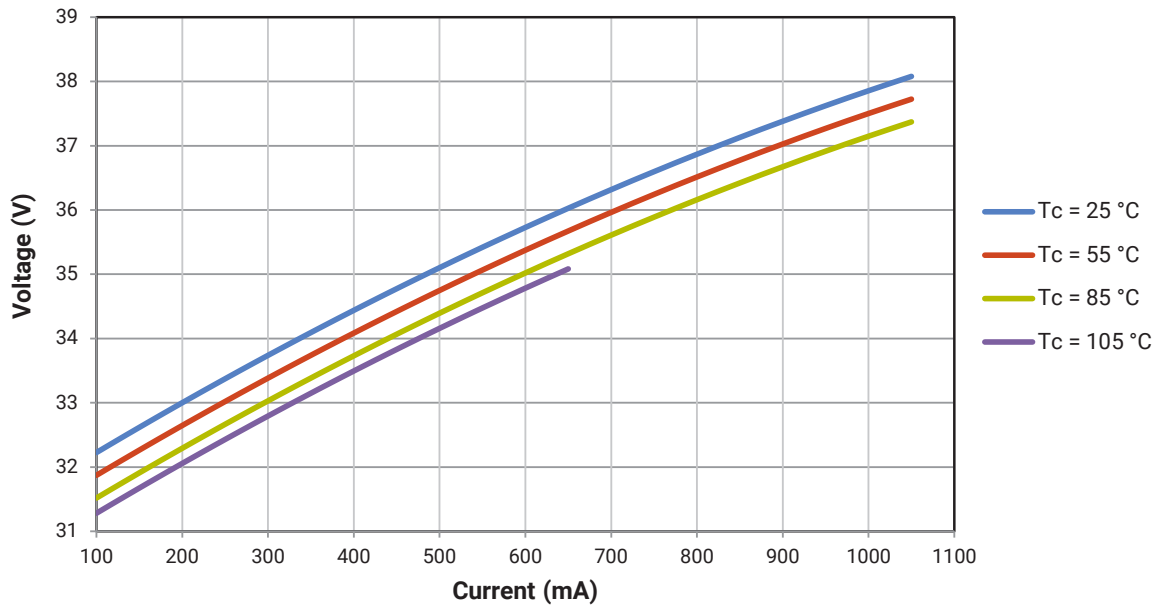

RELATIVE LUMINOUS FLUX

The relative luminous flux values provided below are the ratio of:

- Measurements of CMA1516 at steady-state operation at the given conditions, divided by
- Flux measured during binning, which is a pulsed measurement at 450 mA at $T_j = 85\text{ }^\circ\text{C}$.

For example, at steady-state operation of $T_c = 55\text{ }^\circ\text{C}$, $I_f = 700\text{ mA}$, the relative luminous flux ratio is 150% in the chart below. A CMA1516 LED that measures 1900 lm during binning will deliver 2850 lm (1900×1.5) at steady-state operation of $T_c = 55\text{ }^\circ\text{C}$, $I_f = 700\text{ mA}$.

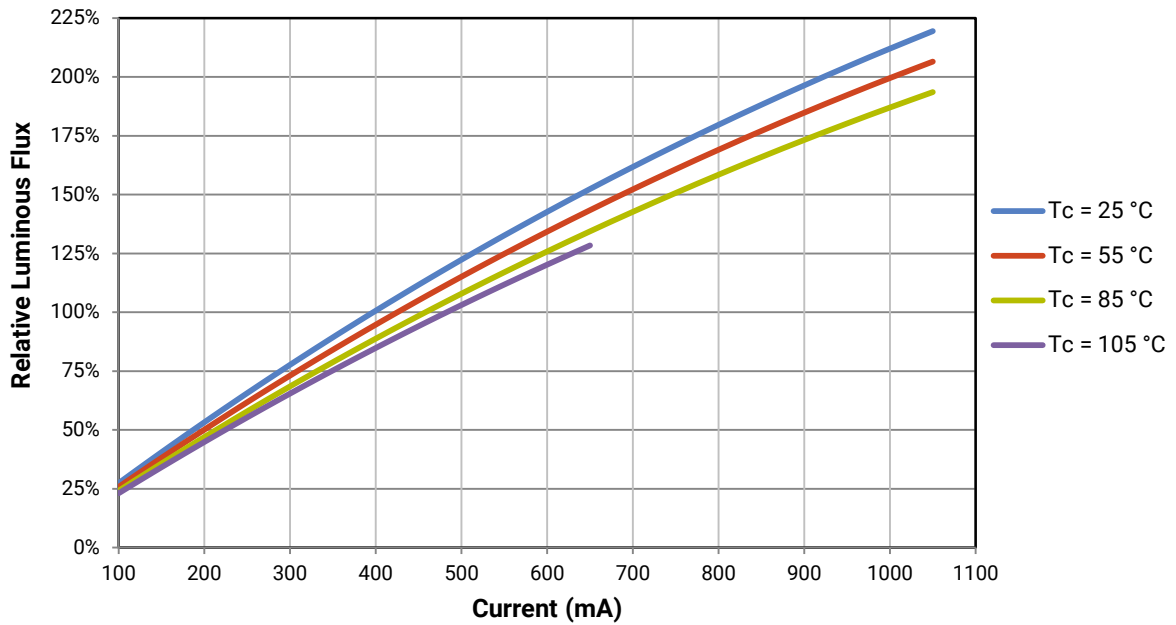

TYPICAL SPATIAL DISTRIBUTION

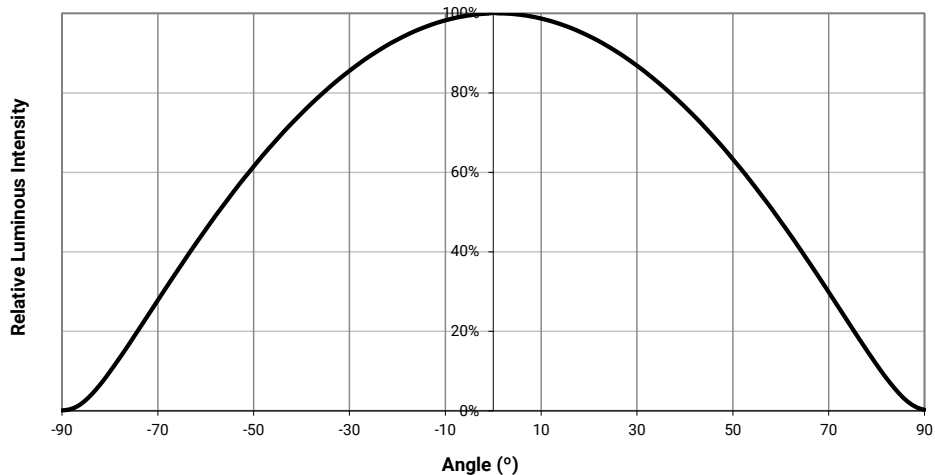

EASYWHITE® PERFORMANCE GROUPS - CHROMATICITY ($T_j = 85\text{ °C}$)

XLamp CMA1516 LEDs are tested for chromaticity and placed into one of the regions defined by the following bounding coordinates.

EasyWhite Color Temperatures – 2-Step			
Code	CCT	x	y
40H	4000 K	0.3777	0.3739
		0.3797	0.3816
		0.3861	0.3855
		0.3838	0.3777
35H	3500 K	0.4022	0.3858
		0.4053	0.3942
		0.4125	0.3977
		0.4091	0.3891
30H	3000 K	0.4287	0.3975
		0.4328	0.4064
		0.4390	0.4086
		0.4347	0.3996
27H	2700 K	0.4524	0.4048
		0.4574	0.4140
		0.4633	0.4154
		0.4581	0.4062

EasyWhite Color Temperatures – 3-Step Ellipse						
Bin Code	CCT	Center Point		Major Axis	Minor Axis	Rotation Angle (°)
		x	y	a	b	
65G	6500 K	0.3123	0.3282	0.00666	0.00330	61.0
57G	5700 K	0.3287	0.3417	0.00738	0.00360	72.0
50G	5000 K	0.3447	0.3553	0.00840	0.00312	65.0
40G	4000 K	0.3818	0.3797	0.00939	0.00402	53.7
35G	3500 K	0.4073	0.3917	0.00927	0.00414	54.0
30G	3000 K	0.4338	0.4030	0.00834	0.00408	53.2
27G	2700 K	0.4577	0.4099	0.00834	0.00420	48.5
22G	2200 K	0.5066	0.4158	0.00980	0.00480	45.5

EasyWhite Color Temperatures – 5-Step Ellipse						
Bin Code	CCT	Center Point		Major Axis	Minor Axis	Rotation Angle (°)
		x	y	a	b	
65E	6500 K	0.3123	0.3282	0.01110	0.00550	61.0
57E	5700 K	0.3287	0.3417	0.01230	0.00600	72.0
50E	5000 K	0.3447	0.3553	0.01400	0.00520	65.0
40E	4000 K	0.3818	0.3797	0.01565	0.00670	53.7
30E	3000 K	0.4338	0.4030	0.01390	0.00680	53.2

PREMIUM COLOR PERFORMANCE GROUPS - CHROMATICITY ($T_j = 85\text{ }^\circ\text{C}$)

XLamp CMA1516 LEDs are tested for chromaticity and placed into one of the regions defined by the following bounding coordinates.

Fidelity

EasyWhite Color Temperatures – 2-Step			
Code	CCT	x	y
L5A	4000 K	0.3764	0.3711
		0.3784	0.3787
		0.3847	0.3826
		0.3825	0.3748
35H	3500 K	0.4022	0.3858
		0.4053	0.3942
		0.4125	0.3977
		0.4091	0.3891
30H	3000 K	0.4287	0.3975
		0.4328	0.4064
		0.4390	0.4086
		0.4347	0.3996
27H	2700 K	0.4524	0.4048
		0.4574	0.4140
		0.4633	0.4154
		0.4581	0.4062

Specialty

EasyWhite Color Temperatures – 2-Step			
Code	CCT	x	y
L7B	3000 K	0.4263	0.3848
		0.4296	0.3916
		0.4361	0.3938
		0.4326	0.3868
L7C	3000 K	0.4192	0.3754
		0.4224	0.3823
		0.4291	0.3847
		0.4257	0.3777

EasyWhite Color Temperatures – 3-Step Ellipse						
Bin Code	CCT	Center Point		Major Axis	Minor Axis	Rotation Angle (°)
		x	y	a	b	
31Q	3100 K	0.4236	0.3888	0.00848	0.00455	50.3
30Q	3000 K	0.4305	0.3935	0.00834	0.00408	53.2
30U	3000 K	0.4274	0.3837	0.00834	0.00408	53.2

EASYWHITE® BINS PLOTTED ON THE 1931 CIE COLOR SPACE ($T_j = 85^\circ\text{C}$)



PREMIUM COLOR BINS PLOTTED ON THE 1931 CIE COLOR SPACE ($T_j = 85\text{ }^\circ\text{C}$)

Fidelity (2-step)

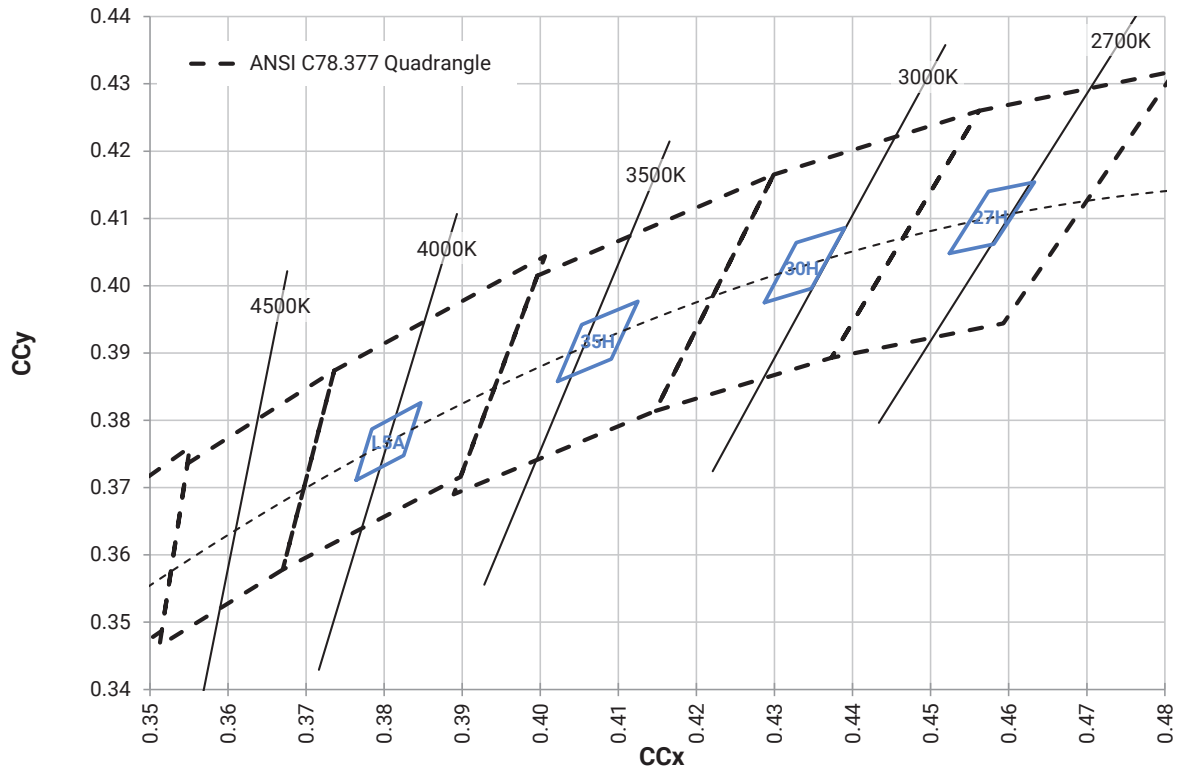

PREMIUM COLOR BINS PLOTTED ON THE 1931 CIE COLOR SPACE ($T_j = 85\text{ }^\circ\text{C}$) - CONTINUED

Speciality (2-step)

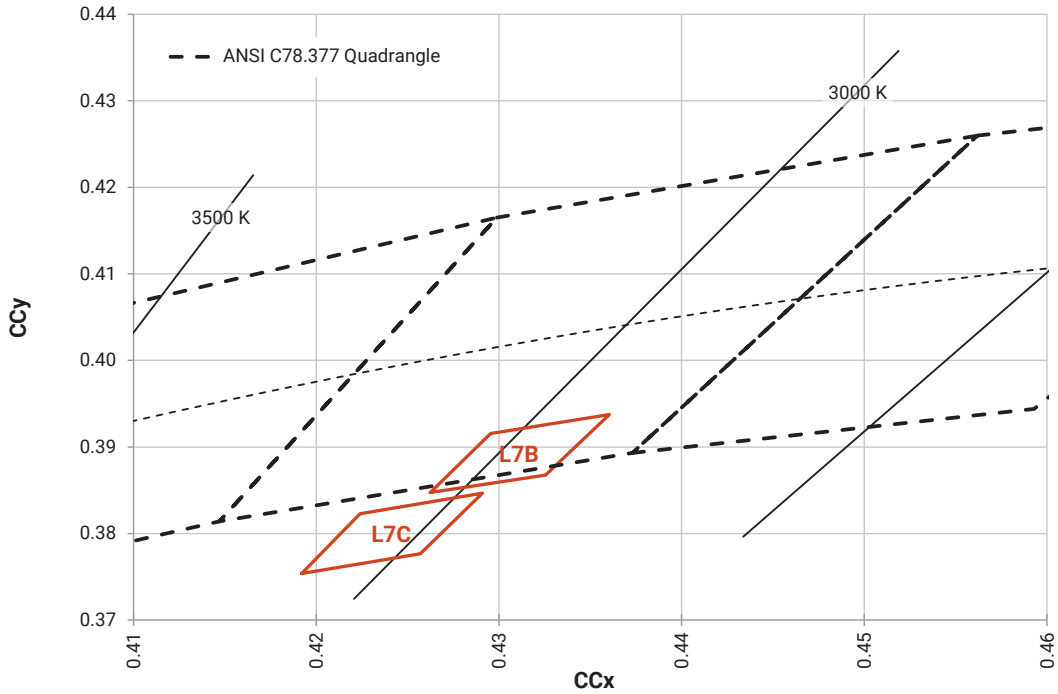

Speciality (3-step)

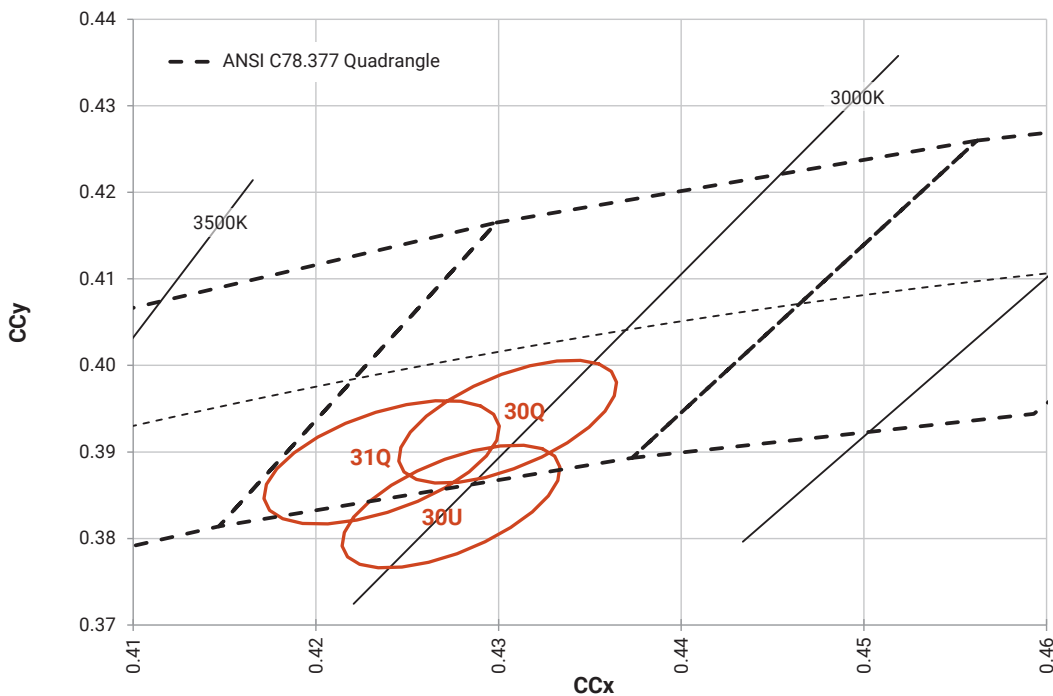

BIN AND ORDER CODE FORMATS

Bin codes and order codes are configured as follows:

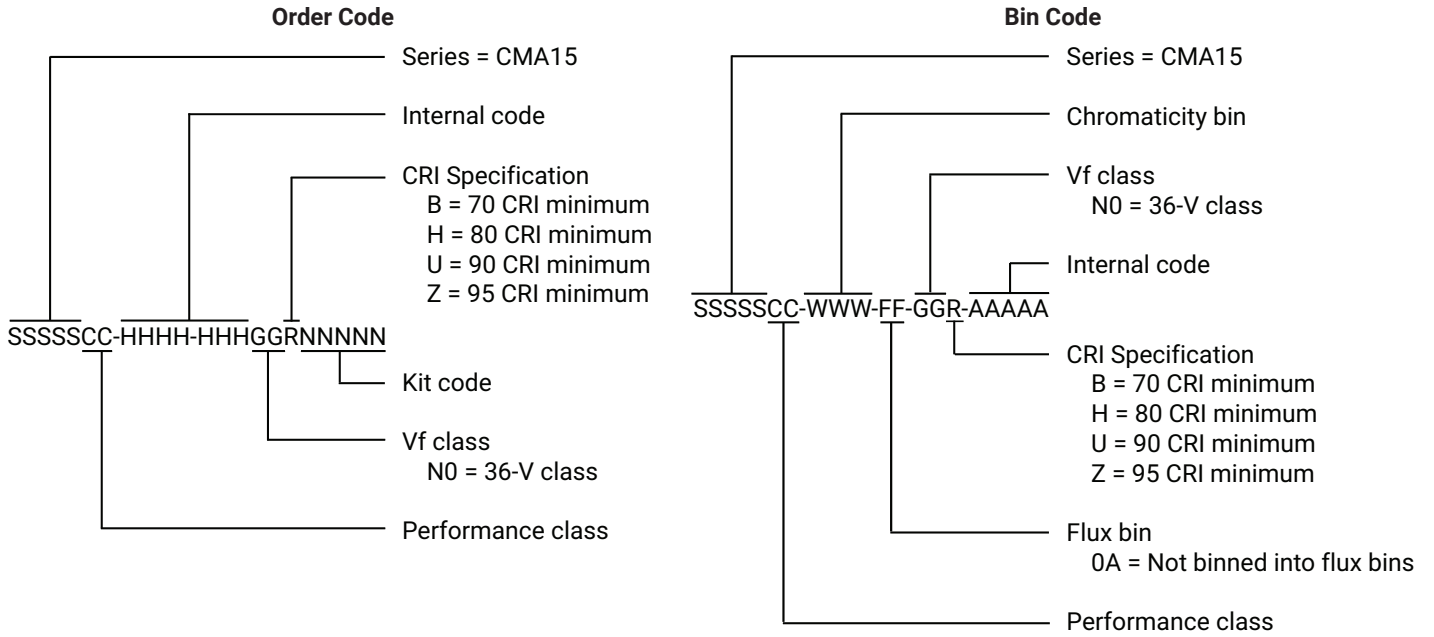

MECHANICAL DIMENSIONS

Dimensions are in mm.

Tolerances unless otherwise specified: $\pm .13$

$x^\circ \pm 1^\circ$

Meaning of LED marking

M1516N = 36-V CMA1516

X1 X2 X3 X4 X5

X1 CCT

1 = 6500 K

2 = 5700 K

3 = 5000 K

5 = 4000 K

6 = 3500 K

7 = 3000 K

8 = 2700 K

A = 2200 K

X2

M = EasyWhite or

Fidelity LED on the
black-body line

Q = Specialty LED below
the black-body line

U = Specialty LED below
the black-body line

X3 Flux bin

X4

0A = Not binned into flux
bins

X5 CRI

B = 70 CRI min

H = 80 CRI min

U = 90 CRI min

Z = 95 CRI min

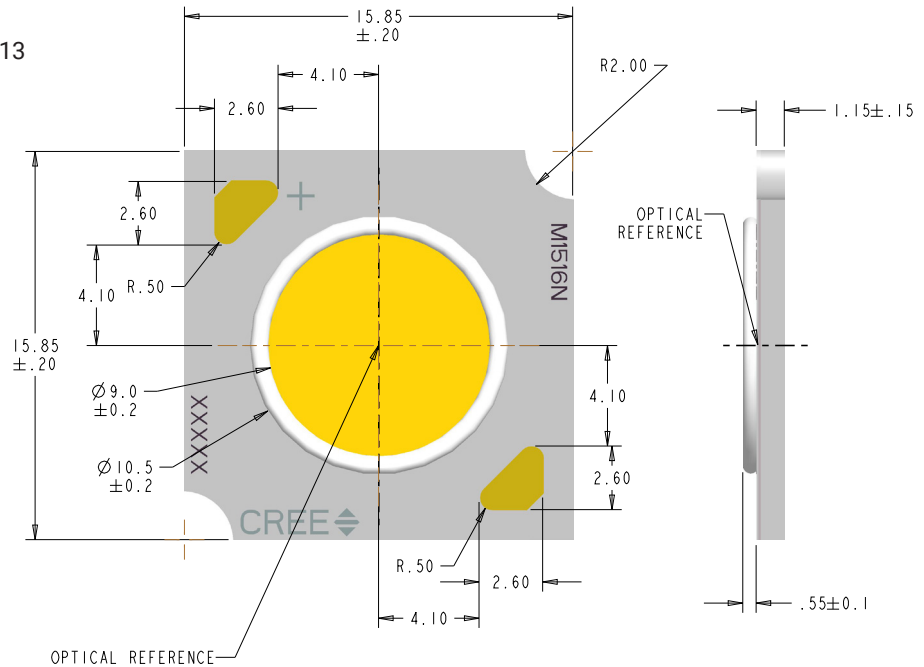

Tc measurement point: either the anode or cathode solder pad

THERMAL DESIGN

The CMA family of LED arrays can include over a hundred different LED die inside one package, and thus over a hundred different junction temperatures (T_j). Cree LED has intentionally removed junction-temperature-based operating limits and replaced the commonplace maximum T_j calculations with maximum ratings based on forward current (I_f) and case temperature (T_c). No additional calculations are required to ensure that the CMA LED is being operated within its designed limits. LES temperature measurement provides additional verification of good thermal design. Please refer to page 2 for the Operating Limit specifications.

There is no need to calculate for T_j inside the package, as the thermal management design process, specifically from solder point (T_{sp}) to ambient (T_a), remains identical to any other LED component. For more information on thermal management of XLamp LEDs, please refer to the [Thermal Management application note](#). For CMU soldering recommendations and more information on thermal interface materials (TIM), LES temperature measurement, and connection methods, please refer to the [XLamp CM Family LEDs soldering and handling document](#).

To keep the CMA1516 LED at or below the maximum rated T_c , the case to ambient temperature thermal resistance (R_{c-a}) must be at or below the maximum R_{c-a} value shown on the following graph, depending on the operating environment. The y-axis in the graph is a base 10 logarithmic scale.

As the figure at right shows, the R_{c-a} value is the sum of the thermal resistance of the TIM (R_{tim}) plus the thermal resistance of the heat sink (R_{hs}).

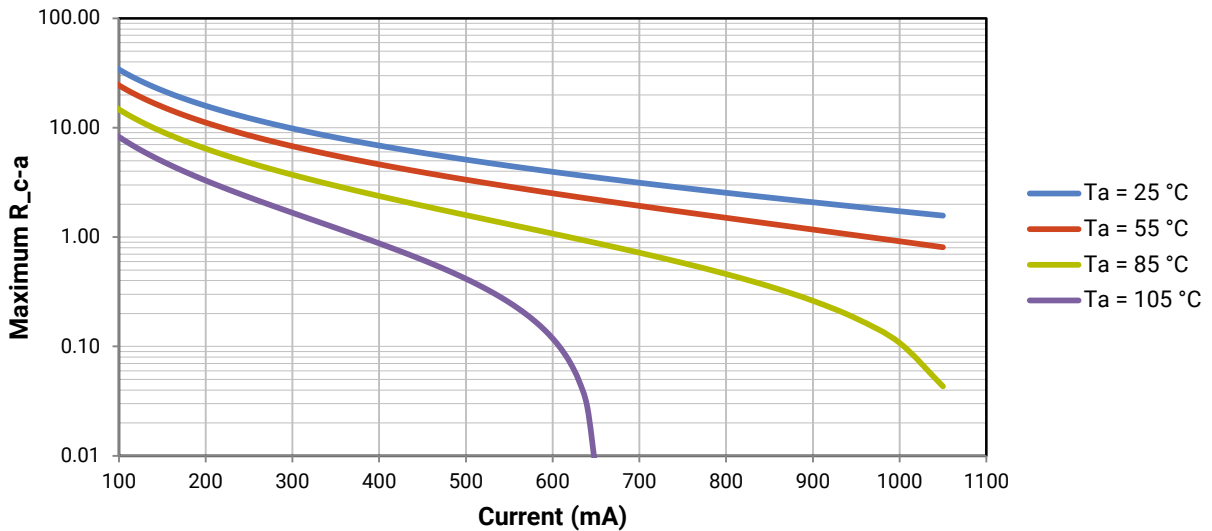
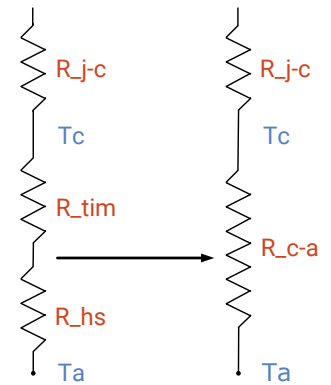

NOTES

Measurements

The luminous flux, radiant power, chromaticity, forward voltage and CRI measurements in this document are binning specifications only and solely represent product measurements as of the date of shipment. These measurements will change over time based on a number of factors that are not within Cree LED's control and are not intended or provided as operational specifications for the products. Calculated values are provided for informational purposes only and are not intended or provided as specifications.

Pre-Release Qualification Testing

Please read the [LED Reliability Overview](#) for details of the qualification process Cree LED applies to ensure long-term reliability for XLamp LEDs and details of Cree LED's pre-release qualification testing for XLamp LEDs. Cree LED did not perform Room Temperature Operating Life (RTOL) testing on the CMA1516 LED.

Lumen Maintenance

Cree LED now uses standardized IES LM-80-08 and TM-21-11 methods for collecting long-term data and extrapolating LED lumen maintenance. For information on the specific LM-80 data sets available for this LED, refer to the public [LM-80 results document](#).

Please read the [Long-Term Lumen Maintenance application note](#) for more details on Cree LED's lumen maintenance testing and forecasting. Please read the [Thermal Management application note](#) for details on how thermal design, ambient temperature, and drive current affect the LED junction temperature.

RoHS Compliance

The levels of RoHS restricted materials in this product are below the maximum concentration values (also referred to as the threshold limits) permitted for such substances, or are used in an exempted application, in accordance with EU Directive 2011/65/EC (RoHS2), as implemented January 2, 2013. RoHS Declarations for this product can be obtained from your Cree LED representative or from the [Product Ecology](#) section of the Cree LED website.

REACH Compliance

REACH substances of very high concern (SVHCs) information is available for this product. Since the European Chemical Agency (ECHA) has published notice of their intent to frequently revise the SVHC listing for the foreseeable future, please contact a Cree LED representative to insure you get the most up-to-date REACH SVHC Declaration. REACH banned substance information (REACH Article 67) is also available upon request.

UL® Recognized Component

This product meets the requirements to be considered a UL Recognized Component with Level 4 enclosure consideration. The LED package or a portion thereof has been investigated as a fire and electrical enclosure per ANSI/UL 8750.

Vision Advisory

WARNING: Do not look at an exposed lamp in operation. Eye injury can result. For more information about LEDs and eye safety, please refer to the [LED Eye Safety application note](#).

PACKAGING

Cree LED CMA1516 LEDs are packaged in trays of 20. Five trays are sealed in an anti-static bag and placed inside a carton, for a total of 100 LEDs per carton. Each carton contains 100 LEDs from the same performance bin.

Dimensions are in inches.
Tolerances: ±.13
x° ±1°



PATENT LABEL IS LOCATED ON UNDERSIDE OF CARTON

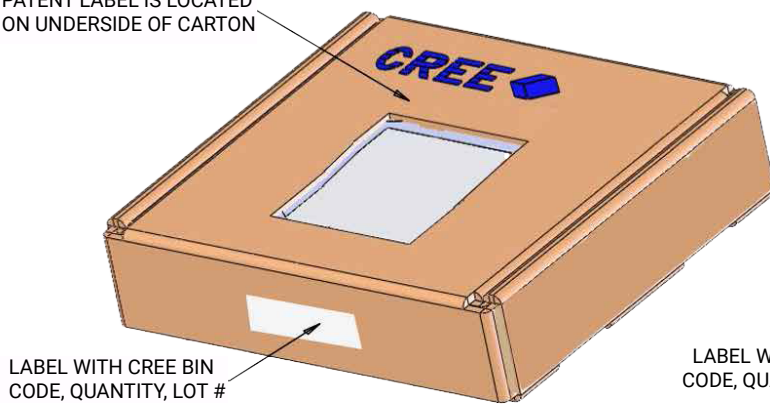

BAG

LABEL WITH CREE BIN CODE, QUANTITY, LOT #

