

DESCRIPTION: HIGH DENSITY - MALE - RIGHT ANGLE

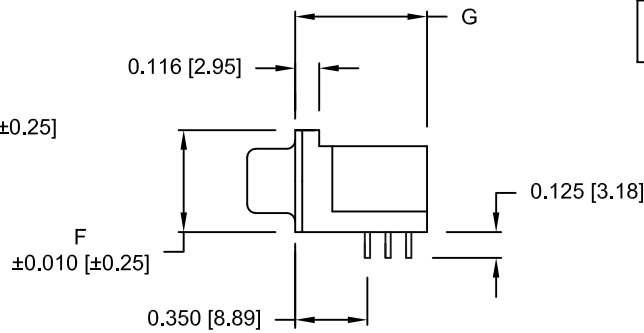
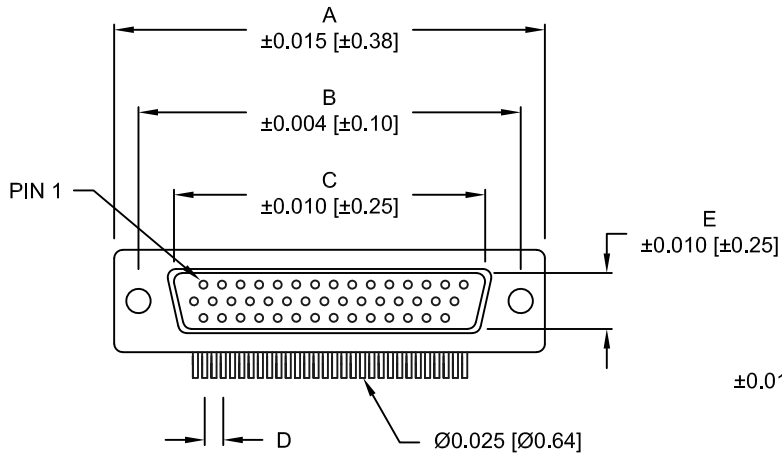

DIMENSIONS (IN.)							
No. OF PINS	A	B	C	D	E	F	G
15	1.213	0.984	0.666	0.090	0.329	0.496	0.639
	30.80	24.99	16.92	2.29	8.36	12.60	16.23
26	1.543	1.312	0.994	0.090	0.329	0.496	0.639
	39.19	33.32	25.25	2.29	8.36	12.60	16.23
44	2.087	1.852	1.534	0.090	0.329	0.496	0.639
	53.00	47.04	38.96	2.29	8.36	12.60	16.23
62	2.732	2.500	2.156	0.095	0.329	0.496	0.639
	69.30	63.50	54.76	2.41	8.36	12.60	16.23

ELECTRICAL:
 CURRENT RATING: 3 AMPS
 CONTACT RESISTANCE: 15 MilliOhms Max.
 INSULATION RESISTANCE: 1,000 MEGOhms Min. at 500 VDC
 DIELECTRIC WITHSTANDING VOLTAGE: 1,000 VAC FOR 1 MINUTE
 WORKING VOLTAGE: 250 VAC
 TEMPERATURE: -55°C TO +105°C

MATERIALS:
 SHELL: SPCC, NICKEL PLATED
 INSULATOR: PA9T-BLACK (UL94-0)
 CONTACT: BRASS, GOLD ENTIRE CONTACT
 RIVET: COPPER ALLOY, NICKEL PLATED
 BOARDLOCK: SPCC, TIN PLATED
 SCREWLOCK: ZINC ALLOY, NICKEL PLATED

181-YYY-1 1 3 R YY 1

SERIES _____
 POSITIONS _____
 015
 026
 044
 062
 GENDER _____
 1 = MALE
 TERMINATION _____
 1 = DIP SOLDER
 SHELL PLATING _____
 3 = NICKEL PLATED
 RoHS COMPLIANT _____
 (HIGH TEMP. PROCESS)
 HARDWARE OPTIONS _____
 16 = Ø 0.120 HOLE / INSIDE GND STRAPS
 17 = 4-40 INSERTS / INSIDE GND STRAPS
 18 = 4-40 SCREWLOCKS / INSIDE GND STRAPS
 43 = Ø 0.120 HOLE / METAL SHELL
 45 = 4-40 INSERTS / METAL SHELL
 48 = 4-40 SCREWLOCKS / METAL SHELL
 53 = 4-40 INSERTS / BOARDLOCKS
 55 = Ø 0.120 HOLE / BOARDLOCKS
 56 = 4-40 SCREWLOCKS / BOARDLOCKS
 PLATING OPTIONS _____
 1 = GOLD FLASH

DO NOT SCALE FROM DRAWING

	THESE DRAWINGS AND SPECIFICATIONS ARE THE PROPERTY OF NorComp AND SHALL NOT BE REPRODUCED, COPIED OR USED AS THE BASIS FOR THE MANUFACTURE OR SALE OF APPARATUS WITHOUT WRITTEN PERMISSION.		DRAWN: PAM JENKINS	DATE: 03-17-05
	<h1>NorComp</h1>		SCALE: NTS	SHEET 1 OF 3
DWG NO. 181-YYY-113RYY1				

RoHS COMPLIANT

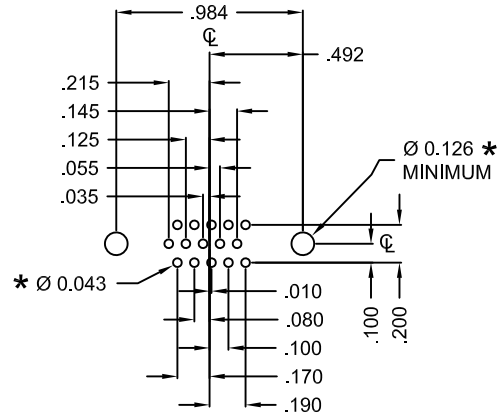

15 POSITION

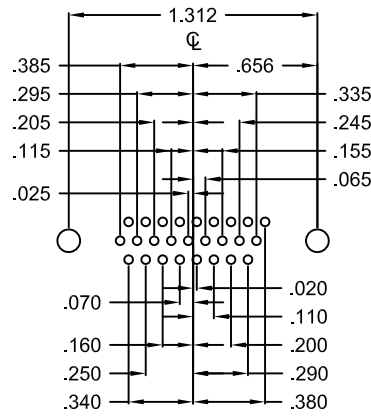

26 POSITION

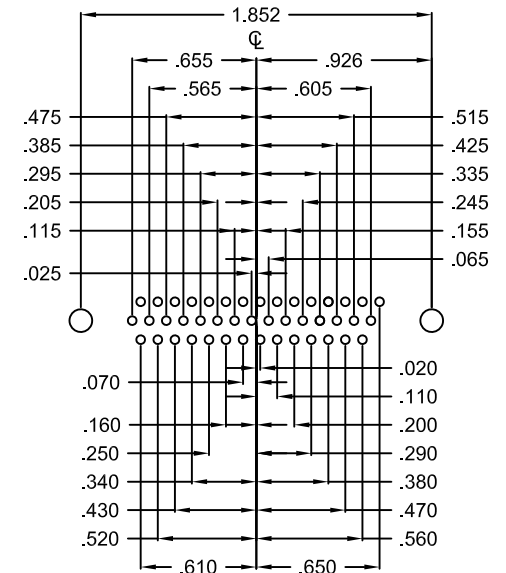

44 POSITION

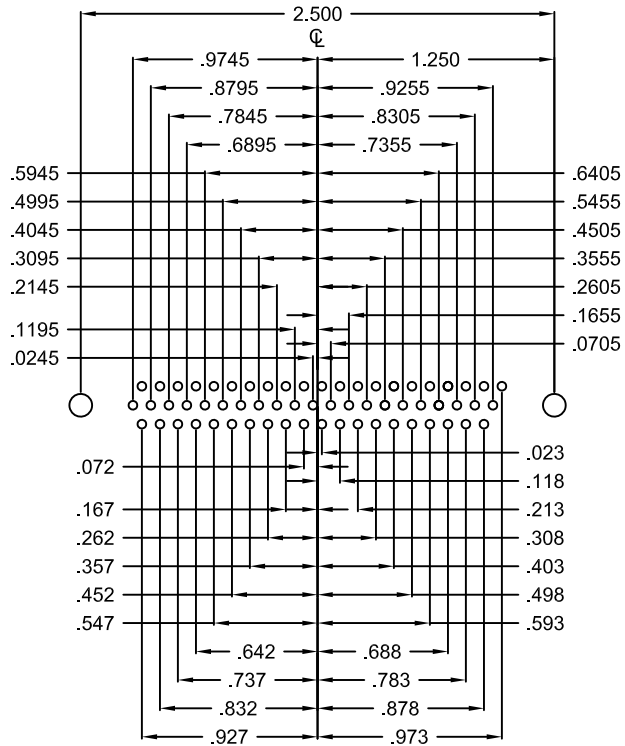

62 POSITION

HOLE PATTERN SHOWN
ARE FOR MALE

UNITS = inch

* TYP.
SUGGESTED SIZE
MAY NOT BE SUITABLE FOR ALL APPLICATIONS

DO NOT SCALE FROM DRAWING



THESE DRAWINGS AND SPECIFICATIONS ARE THE PROPERTY OF NorComp AND SHALL NOT BE REPRODUCED, COPIED OR USED AS THE BASIS FOR THE MANUFACTURE OR SALE OF APPARATUS WITHOUT WRITTEN PERMISSION.

DRAWN: PAM JENKINS
DATE: 03-17-05

NorComp

SCALE: NTS SHEET 2 OF 3 REV 15

DWG NO. 181-YYY-113RYY1

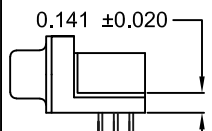
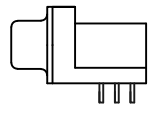
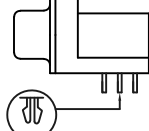
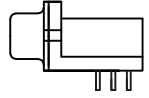
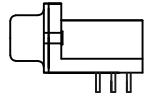
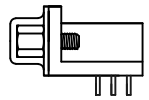
	 <p>0.141 ±0.020</p> <p>METAL SHELL WITH INSIDE GROUND STRAPS</p>	 <p>METAL SHELL</p>	 <p>METAL SHELL FORK BOARD LOCKS</p>
 <p>.120" DIA. HOLE</p>	16	43	55
 <p>4-40 FLUSH INSERT</p>	17	45	53
 <p>4-40 HEX STANDOFF* FEMALE SCREWLOCK</p>	18	48	56

*4.80mm Reference Hex Height

DO NOT SCALE FROM DRAWING

	THESE DRAWINGS AND SPECIFICATIONS ARE THE PROPERTY OF NorComp AND SHALL NOT BE REPRODUCED, COPIED OR USED AS THE BASIS FOR THE MANUFACTURE OR SALE OF APPARATUS WITHOUT WRITTEN PERMISSION.		DRAWN: PAM JENKINS	DATE: 03-17-05
	<h1>NorComp</h1>		SCALE: NTS	SHEET 3 OF 3
DWG NO. 181-YYY-113RYY1				

RoHS COMPLIANT