

Powerex, Inc., 200 Hillis Street, Youngwood, Pennsylvania 15697-1800 (412) 925-7272
 Powerex, Europe, S.A. 428 Avenue G. Durand, BP107, 72003 Le Mans, France (43) 41.14.14

Phase Control SCR
 310 Amperes Average
 1600 Volts

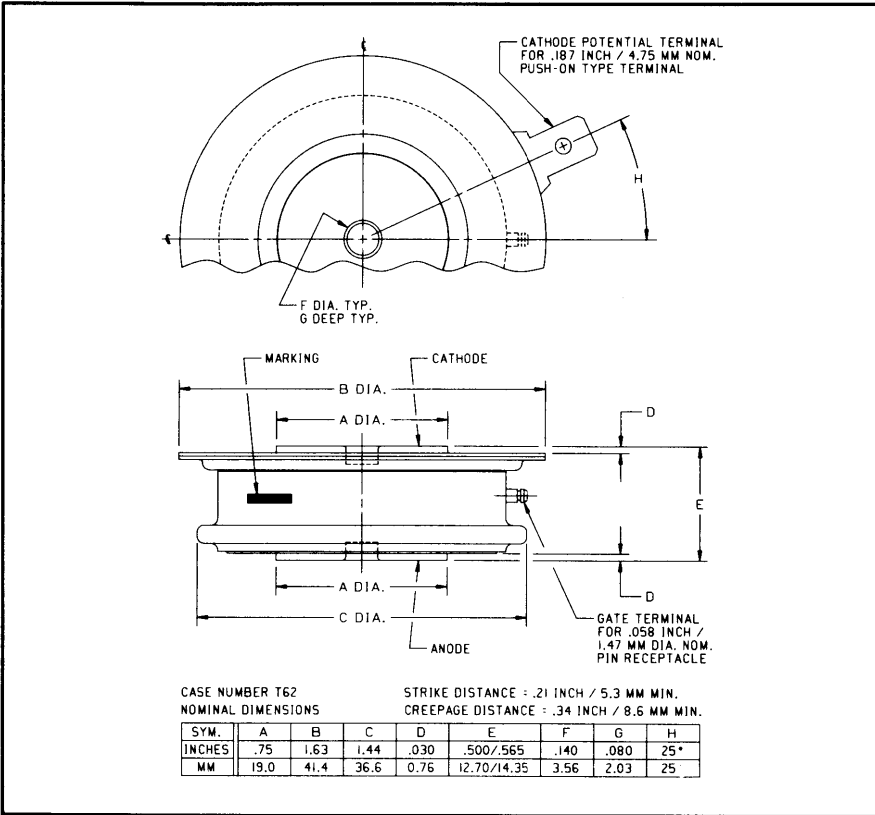

C380__X500 (Outline Drawing)

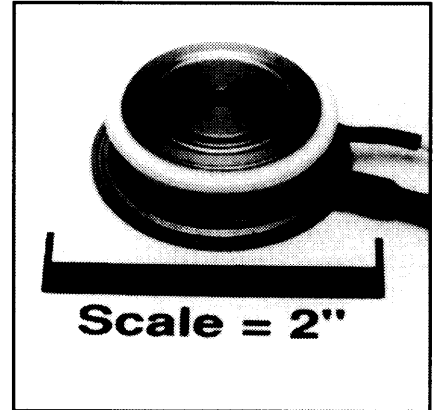

C380__X500 Phase Control SCR
 310 Amperes Average, 1600 Volts

Ordering Information:

Select the complete nine digit part number you desire from the table, i.e. C380PMX500 is a 1600 Volt, 310 Ampere Phase Control SCR.

Type	Voltage		Current
	V _{DRM} V _{RRM}	Code	I _{T(av)}
C380__X500	200	B	310
	400	D	
	600	M	
	800	N	
	1000	P	
	1200	PB	
	1400	PD	
1600	PM		

Description:

Powerex Silicon Controlled Rectifiers (SCR) are designed for phase control applications. These are all-diffused, Press-Pak (Pow-R-Disc) devices employing the field-proven amplifying (di/namic) gate.

Features:

- Low On-State Voltage
- High di/dt
- High dv/dt
- Hermetic Packaging
- Excellent Surge and I²t Ratings

Applications:

- Power Supplies
- Battery Chargers



Powerex, Inc., 200 Hillis Street, Youngwood, Pennsylvania 15697-1800 (412) 925-7272
 Powerex, Europe, S.A. 428 Avenue G. Durand, BP107, 72003 Le Mans, France (43) 41.14.14

C380_X500
 Phase Control SCR
 310 Amperes Average, 1600 Volts

Absolute Maximum Ratings

	Symbol	C380_X500	Units
RMS On-State Current @ $T_C = 83^\circ\text{C}$	$I_{T(RMS)}$	500	Amperes
Average On-State Current @ $T_C = 83^\circ\text{C}$	$I_{T(av)}$	310	Amperes
Peak One-Cycle Surge (Non-Repetitive) On-State Current (60Hz)	I_{TSM}	5500	Amperes
Peak One-Cycle Surge (Non-Repetitive) On-State Current (50Hz)	I_{TSM}	5000	Amperes
Critical Rate-of-Rise of On-State Current (Non-Repetitive)	di/dt	800	Amperes/ μs
Critical Rate-of-Rise of On-State Current (Repetitive)	di/dt	500	Amperes/ μs
I^2t (for Fusing), One Cycle at 60Hz	I^2t	125,000	A^2sec
Peak Gate Power Dissipation	P_{GM}	10	Watts
Average Gate Power Dissipation	$P_{G(av)}$	2	Watts
Storage Temperature	T_{STG}	-40 to 150	$^\circ\text{C}$
Operating Temperature	T_J	-40 to 125	$^\circ\text{C}$
Mounting Force		720 to 880	lb.
Mounting Force		3.2 to 3.92	kN

Electrical and Thermal Characteristics

Characteristics	Symbol	Test Conditions	C380_X500	Units
Voltage—Blocking State Maximums				
Forward Leakage, Peak	I_{DRM}	$T_J = 125^\circ\text{C}, V = V_{DRM}$	20	mA
Reverse Leakage, Peak	I_{RRM}	$T_J = 125^\circ\text{C}, V = V_{RRM}$	20	mA
Current—Conducting State Maximums				
Peak On-State Voltage	V_{TM}	$T_C = 125^\circ\text{C}, I_{TM} = 1500\text{A}, \text{Duty Cycle} = 0.01\%$	1.75	Volts
Switching				
Typical Turn-On Delay	t_d	$T_C = 25^\circ\text{C}, I_T = 100\text{A}, V_{DRM} = \text{rated}.$ Gate Supply 10V Open Circuit, 25 Ω , 0.1 μsec max. rise time	1	μsec
Min. Critical dv/dt exponential to V_{DRM}	dv/dt	$T_J = 125^\circ\text{C}, \text{Gate open circuited}.$	200	V/ μsec
Thermal				
Maximum Thermal Resistance, double sided cooling Junction to Case	$R_{\theta JC}$		0.095	$^\circ\text{C}/\text{Watt}$
Case to Sink, Lubricated	$R_{\theta CS}$		0.02	$^\circ\text{C}/\text{Watt}$
Gate—Maximum Parameters				
Gate Current to Trigger	I_{GT}	$T_C = 25^\circ\text{C}, V_D = 6\text{V}, R_L = 3 \Omega$	150	mA
Gate Voltage to Trigger	V_{GT}	$T_C = -40^\circ\text{C} \text{ to } 125^\circ\text{C}, V_D = 6\text{V}, R_L = 3 \Omega$	3.0	Volts
Non-Triggering Gate Voltage	V_{GDM}	$T_J = 125^\circ\text{C}, \text{Rated } V_{DRM}, R_L = 1000 \Omega$	0.15	Volts
Peak Forward Gate Current	I_{GTM}		10	Amperes
Peak Reverse Gate Voltage	V_{GRM}		5	Volts

Powerex, Inc., 200 Hillis Street, Youngwood, Pennsylvania 15697-1800 (412) 925-7272
 Powerex, Europe, S.A. 428 Avenue G. Durand, BP107, 72003 Le Mans, France (43) 41.14.14

C380_X500
Phase Control SCR
 310 Amperes Average, 1600 Volts

MAXIMUM ON-STATE CHARACTERISTICS

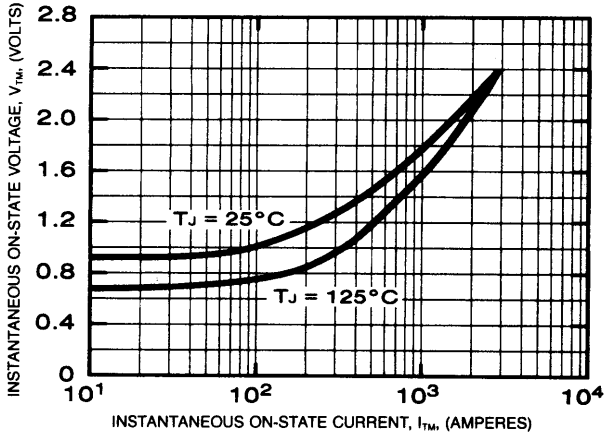

TRANSIENT THERMAL IMPEDANCE CHARACTERISTICS (JUNCTION TO CASE)

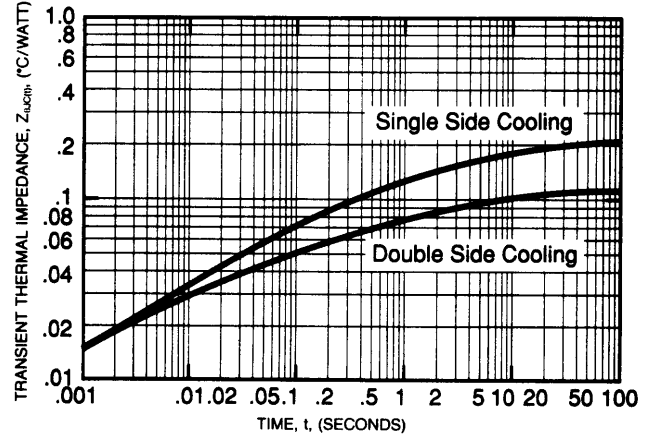

MAXIMUM ALLOWABLE CASE TEMPERATURE (SINUSOIDAL WAVEFORM)

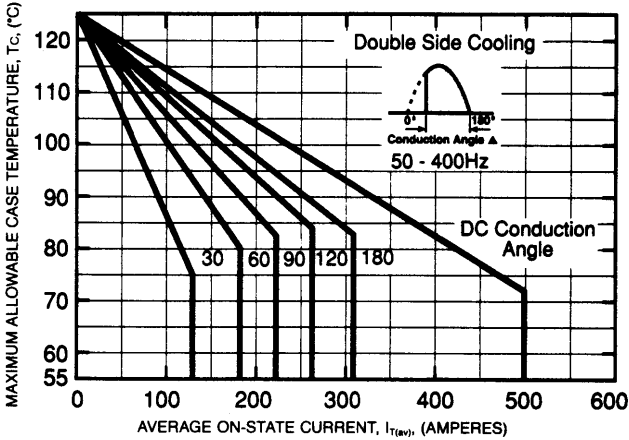

MAXIMUM ON-STATE POWER DISSIPATION (SINUSOIDAL WAVEFORM)

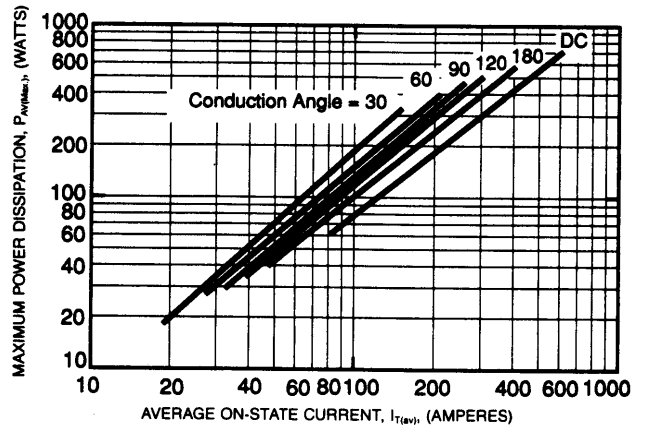

MAXIMUM ALLOWABLE CASE TEMPERATURE (RECTANGULAR WAVEFORM)

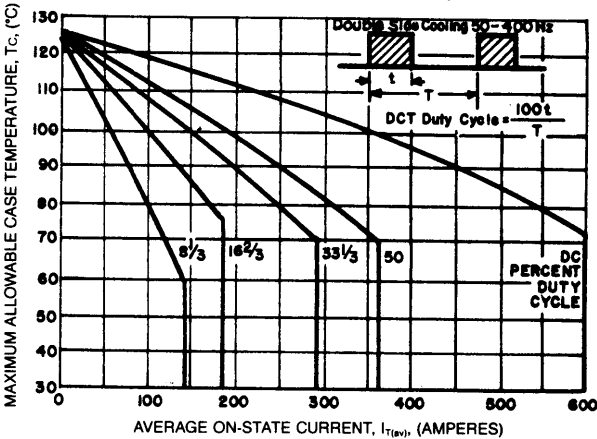

MAXIMUM ON-STATE POWER DISSIPATION (RECTANGULAR WAVEFORM)

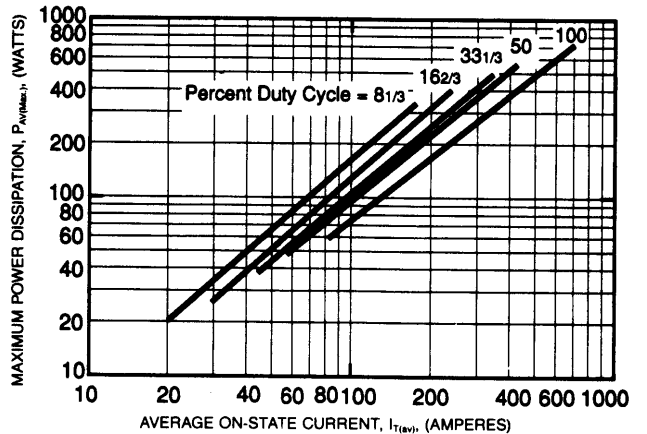

Powerex, Inc., 200 Hillis Street, Youngwood, Pennsylvania 15697-1800 (412) 925-7272
 Powerex, Europe, S.A. 428 Avenue G. Durand, BP107, 72003 Le Mans, France (43) 41.14.14

C380_X500
Phase Control SCR
 310 Amperes Average, 1600 Volts

SUB-CYCLE SURGE AND I^2t RATINGS
 (RATED LOAD CONDITIONS)

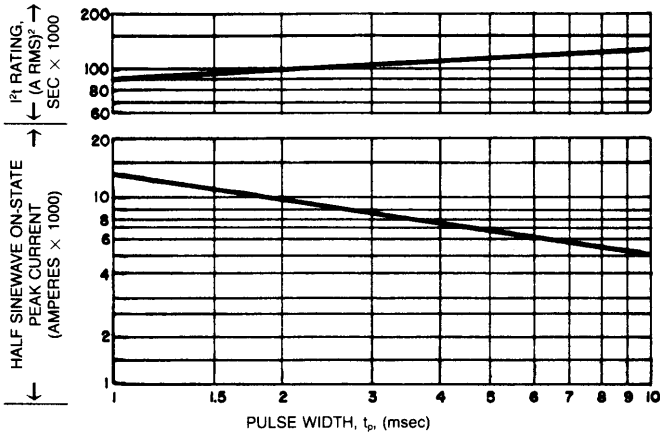

GATE CHARACTERISTICS

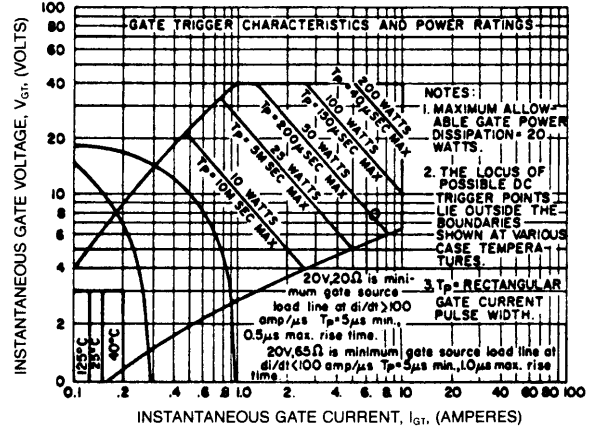

- NOTES:**
1. Maximum allowable gate power dissipation = 2 watts.
 2. The locus of possible DC trigger points lie outside the boundaries shown at various case temperatures.
 3. T_p = Rectangular Gate Current Pulse Width.