

SPL/SWA SERIES

PROVEN TECHNOLOGY SWITCHERS

- Over 1,000,000 SPL Series Units Shipped
- Cost Effective Proven Technology
- Worldwide AC Input: 90-132/180-264 VAC
- 2 Year Warranty



SPL40
SINGLE OUTPUT

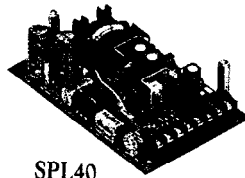

SPL40
MULTIPLE OUTPUT

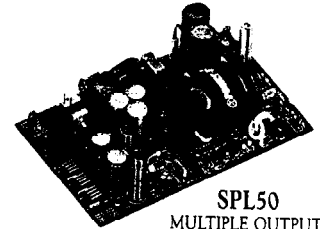

SPL50
MULTIPLE OUTPUT

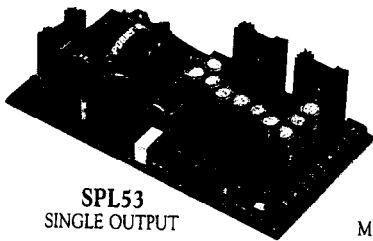

SPL53
SINGLE OUTPUT

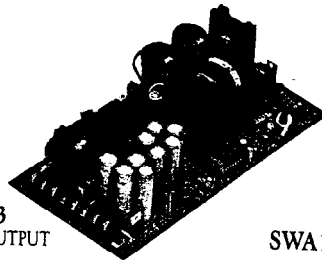

SPL53
MULTIPLE OUTPUT

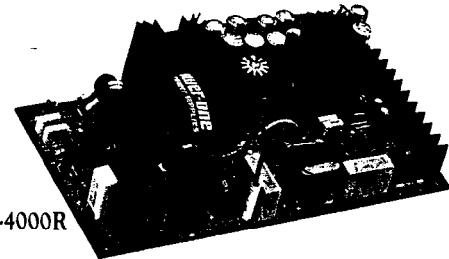

SWA125-4000R

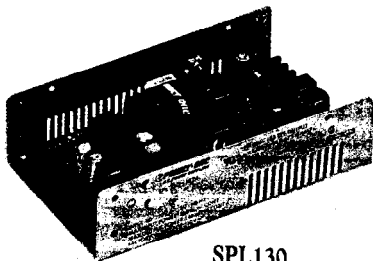

SPL130
SINGLE OUTPUT

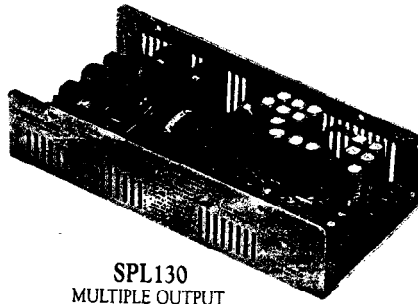

SPL130
MULTIPLE OUTPUT

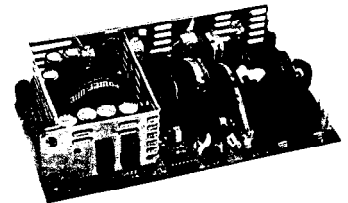

SPL175
MULTIPLE OUTPUT

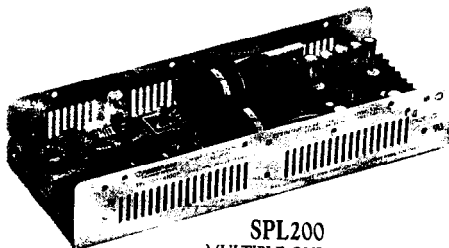

SPL200
MULTIPLE OUTPUT

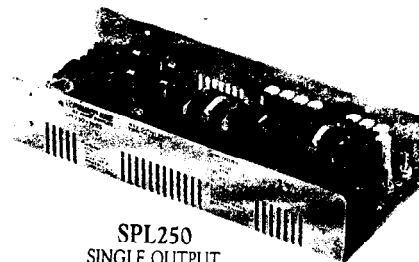

SPL250
SINGLE OUTPUT

SPL/SWA SERIES

GENERAL SPECIFICATIONS

AC Input:

Standard dual range: 90-132 VAC or 180-264 VAC, user selectable.
47-63 Hz, single phase. Consult factory for 400 Hz operation.

DC Outputs:

See Voltage/Current Rating Charts

Output Power:

See Voltage/Current Rating Charts

Brown-Out Protection:

Regulation is maintained down to 90/180 VAC, at full load, with no compromise in performance.

Hold-Up Time:

20 msec minimum at full rated load and nominal AC input voltage.
Hold-up time increases to 40 msec at 50% load.

Power-Fail Warning Signal:

Single Output Models: Provided on SPL250 models only. TTL compatible signal goes low 10 msec minimum before the output voltage drops 5%, at a 100% load condition.

Multiple Output Models: Provided on models with a "P" suffix. Signal goes low 5 msec minimum before +5V main output drops 5%, at a 100% load condition.

Warning time increases at reduced load levels.

Efficiency:

Measured at full rated output power and nominal AC input voltage. 70% ± 5% depending on how the load is distributed among the outputs.

Regulation Characteristics:

See Voltage/Current Rating Charts for individual model ratings.
Measurement method (unless otherwise noted):

Line: Measured over a 90-132 VAC or 180-264 VAC line change.

Load: Measured by varying the load current from 60% to either 20% or 100% of full rated.

Cross Regulation:

Multiple Output Models: Where indicated, cross regulation specifies the maximum voltage change on an auxiliary output when the +5V main output load current is varied from 75% of full rated to either 50% or 100% of full rated. NOTE: The effect of load and cross regulation are generally not cumulative, and may actually act to cancel each other in an operating system environment.

Minimum Load:

Single Output Models: 5% of full rated output current.

Multiple Output Models: Minimum load required on the +5V main output for full load capability on auxiliary outputs:

SPL40, SPL50: 1A	SPL175: 3A
SPL53: 2A	SPL200: 6A
SPL130: 5A	SWA125: 4A

Remote Sensing:

Single Output Models: Provided on SPL53, SPL130, and SPL250 series models.

Multiple Output Models: Provided on the +5V main output of SPL130, SPL200.

Output Noise and Ripple:

0.3% RMS, 1% PK-PK maximum.

Output Overshoot:

No overshoot on turn-on or turn-off.

Transient Response:

Recovery Time: 500 μ sec typical for a 50-100% load change and recovery to within 1% of initial voltage set point.

Maximum Excursion: 3% from initial voltage set point.

Multiple Output Models: Above applies to +5V main output only.

Output Overload Protection:

Fully protected against output overload and short circuit.

Automatic recovery upon removal of overload condition.

Overvoltage Protection:

Set at 6.2V \pm 0.6V.

Single Output Models: Provided on all 5V models.

Multiple Output Models: Provided on +5V main output.

Reverse Voltage Protection:

Inherently protected from damage due to application of reverse polarity voltage across DC output terminals.

Input Protection:

AC input line fuse provided. Internally located.

Inrush Current:

Internally limited by thermistor. Cold start, peak current at 230 VAC input. SPL40 through SPL53: 9A maximum.

SPL130 through SPL250: 17A maximum.

Temperature Rating:

Operating: 0°C to +50°C at full rated output power. Consult factory for operating information between +50°C to +70°C.

Storage: -55°C to +85°C.

Temperature Coefficient:

\pm 0.03%/°C typical, \pm 0.05%/°C maximum over entire operating temperature range of 0°C to +70°C.

Cooling:

Convection cooling is adequate where non-restricted air flow is available. When operating in a confined area, forced air cooling is recommended.

Vibration:

Per MIL-STD-810D, Method 514.3, Category 1, Procedure I.

Shock:

Per MIL-STD-810D, Method 516.3, Procedure III.

OPTIONS**Overvoltage Protection:**

Available on all single output models.

Input/Output Connectors:

Quick-disconnect terminals are available for all models except SPL50 and SPL175. Amp or Molex wafer style connectors (.312 centers) are available for SPL40 and SPL53 series models.

Safety Covers:

Available for SPL130, SPL200, and SPL250.

*The SPL Series Is Available At Your
Local Distributor.*

*See The Inside Rear Cover For A Listing
Of Distributors Closest To You.*

SPL/SWA SERIES

GENERAL SPECIFICATIONS AND SINGLE OUTPUT MODELS

SAFETY AGENCIES

- UL1950 w/D3 or UL 478, for individual models consult factory
- CSA1402C
- TÜV certified to EN60950

EMI/RFI

- (FCC) 47CFR15J

VOLTAGE	CONVECTION COOLED POWER (WATTS)		MODEL	CURRENT	LINE REGULATION	LOAD REGULATION	CONFIGURATION
	CONTINUOUS	PEAK					
5V	40	N/A	SPL40-1005	8A	± 0.3%	± 1%	BOARD ONLY 5.75" x 3.93" x 1.68" (146.05mm) x (99.822mm) x (42.672mm)
	80	N/A	SPL53-1005**	16A	± 0.3%	± 1%	BOARD ONLY 8.25" x 4.25" x 2.10" (209.55mm) x (107.95mm) x (53.34mm)
	140	N/A	SPL130-1005	26A	± 0.3%	± 1%	U-CHANNEL CHASSIS 8.90" x 5.00" x 2.45" (226.06mm) x (127mm) x (62.23mm)
	250	N/A	SPL250-1005	50A	± 0.3%	± 1%	U-CHANNEL CHASSIS 12.00" x 4.94" x 2.45" (304.8mm) x (125.476mm) x (62.23mm)
12-15V* ADJUSTABLE	40	N/A	SPL40-1012	3.3A/2.7A	± 0.3%	± 1%	BOARD ONLY 5.75" x 3.93" x 1.68" (146.05mm) x (99.822mm) x (42.672mm)
	80	N/A	SPL53-1012**	6.7A/5.3A	± 0.3%	± 1%	BOARD ONLY 8.25" x 4.25" x 2.10" (209.55mm) x (107.95mm) x (53.34mm)
	130	N/A	SPL130-1012	11A/9A	± 0.3%	± 1%	U-CHANNEL CHASSIS 8.90" x 5.00" x 2.45" (226.06mm) x (127mm) x (62.23mm)
	250	N/A	SPL250-1012	21A/17A	± 0.3%	± 1%	U-CHANNEL CHASSIS 12.00" x 4.94" x 2.45" (304.8mm) x (125.476mm) x (62.23mm)
24-28V* ADJUSTABLE	40	N/A	SPL40-1024	1.6A/1.4A	± 0.3%	± 1%	BOARD ONLY 5.75" x 3.93" x 1.68" (146.05mm) x (99.822mm) x (42.672mm)
	80	N/A	SPL53-1024**	3.3A/2.8A	± 0.3%	± 1%	BOARD ONLY 8.25" x 4.25" x 2.10" (209.55mm) x (107.95mm) x (53.34mm)
	140	N/A	SPL130-1024	5.5A/4.5A	± 0.3%	± 1%	U-CHANNEL CHASSIS 8.90" x 5.00" x 2.45" (226.06mm) x (127mm) x (62.23mm)
	250	N/A	SPL250-1024	10A/7A	± 0.3%	± 1%	U-CHANNEL CHASSIS 12.00" x 4.94" x 2.45" (304.8mm) x (125.476mm) x (62.23mm)

*Models with adjustable voltages have Current Ratings expressed as Current at Lowest Voltage/Current at Highest Voltage.

**See applications note in mechanical drawing.

SPL/SWA SERIES

MULTIPLE OUTPUT MODELS

Mechanical dimensions on pages 60 and 61.

CONVECTION COOLED WATTAGE/30 CFM		MODEL	VOLTAGE	CURRENT	INITIAL SETTING TOLERANCE	LINE REGULATION	LOAD REGULATION	CROSS REGULATION	CONFIGURATION
CONTINUOUS	PEAK								
40	N/A	SPL40 -4000	+5V	5A	ADJUSTABLE NOTE A	± 0.3%	± 1%	N/A	BOARD ONLY 6.30" x 3.92" x 2.00" (160.02mm) x (99.568mm) x (50.8mm)
			+12V	0.5A	± 4% NOTE B	± 0.1%	± 1%	N/A	
			-12V	0.5A	± 4% NOTE B	± 0.1%	± 1%	N/A	
			-5V	0.5A	± 4% NOTE B	± 0.1%	± 1%	N/A	
50	60	SPL50 -3200	+5V	6A	ADJUSTABLE NOTE A	± 0.3%	± 1%	N/A	BOARD ONLY 6.30" x 3.92" x 2.00" (160.02mm) x (99.568mm) x (50.8mm)
			+12V	2A/ 4A PK	± 5% NOTE C	± 0.3%	± 3%	± 5%	
			-12V	0.5A	± 10% NOTE C	± 0.3%	± 5%	± 10%	
80	N/A	SPL53** -4000	+5V NOTE G	8A	ADJUSTABLE NOTE A	± 0.3%	± 1%	N/A	BOARD ONLY 8.25" x 4.25" x 2.10" (209.55mm) x (107.95mm) x (1290.32mm)
			+12V NOTE G	2.5A/ 5A PK	ADJUSTABLE NOTE D	± 0.1%	± 1%	N/A	
			-12V	0.6A	± 4% NOTE B	± 0.1%	± 1%	N/A	
			-5V	0.6A	± 4% NOTE B	± 0.1%	± 1%	N/A	
80	N/A	SPL53** -4101	+5V	8A	ADJUSTABLE NOTE A	± 0.3%	± 1%	N/A	BOARD ONLY 8.25" x 4.25" x 2.10" (209.55mm) x (107.95mm) x (1290.32mm)
			+12V	1.2A	± 4% NOTE B	± 0.1%	± 1%	N/A	
			-12V	0.6A	± 4% NOTE B	± 0.1%	± 1%	N/A	
			+24V	1.5A/ 3A PK	± 5% NOTE C	± 0.5%	± 5%	± 5%	
80	N/A	SPL53** -4102	+5V	8A	ADJUSTABLE NOTE A	± 0.3%	± 1%	N/A	BOARD ONLY 8.25" x 4.25" x 2.10" (209.55mm) x (107.95mm) x (1290.32mm)
			+12V	1.2A	± 4% NOTE B	± 0.1%	± 1%	N/A	
			+12V	2.5A/ 5A PK	± 5% NOTE C	± 0.5%	± 5%	± 5%	
			-12V	0.6A	± 4% NOTE B	± 0.1%	± 1%	N/A	
120	135	SPL130 -4000	+5V	22A	ADJUSTABLE NOTE A	± 0.3%	± 1%	N/A	U-CHANNEL CHASSIS 10.50" x 5.00" x 2.45" (266.7mm) x (127mm) x (62.23mm)
			+12V	3A	ADJUSTABLE NOTE D	± 0.1%	± 1%	N/A	
			-12V	1.5A	± 4% NOTE B	± 0.1%	± 1%	N/A	
			-5V	1.5A	± 4% NOTE B	± 0.1%	± 1%	N/A	
100/125	N/A	SWA125 -4000R	+5V	15A	ADJUSTABLE NOTE A	± 0.3%	± 1%	N/A	BOARD ONLY 9.00" x 4.75" x 2.35" (228.6mm) x (120.65mm) x (59.69mm)
			+12V	4A/ 8A PK	ADJUSTABLE NOTE D	± 0.3%	± 1%	N/A	
			-12V	1.5A	± 4% NOTE B	± 0.1%	± 1%	N/A	
			-5V	1.5A	± 4% NOTE B	± 0.1%	± 1%	N/A	

*See applications note in mechanical drawing.

SPL/SWA SERIES

MULTIPLE OUTPUT MODELS

CONVECTION COOLED WATTAGE/30 CFM		MODEL	VOLTAGE	CURRENT	INITIAL SETTING TOLERANCE	LINE REGULATION	LOAD REGULATION	CROSS REGULATION	CONFIGURATION
CONTINUOUS	PEAK								
130	150	SPL130 -4100P	+5V	20A NOTE E	ADJUSTABLE NOTE A	±0.3%	±1%	N/A	U-CHANNEL CHASSIS 10.50" x 5.00" x 2.45" (266.7mm) x (127mm) x (62.23mm)
			+12V AUX 1	4A/ 6A PK	±5% NOTE C	±0.5%	±5%	±5%	
			+12V	1.5A	±4% NOTE B	±0.1%	±1%	N/A	
			-12V	1.5A	±4% NOTE B	±0.1%	±1%	N/A	
130	150	SPL130 -4101P	+5V	20A NOTE E	ADJUSTABLE NOTE A	±0.3%	±1%	N/A	U-CHANNEL CHASSIS 10.50" x 5.00" x 2.45" (266.7mm) x (127mm) x (62.23mm)
			+12V	1.5A	±4% NOTE B	±0.1%	±1%	N/A	
			-12V	1.5A	±4% NOTE B	±0.1%	±1%	N/A	
			+24V AUX 1	2A/ 4A PK	±5% NOTE C	±0.5%	±5%	±5%	
130	150	SPL130 -4102P	+5V	20A NOTE E	ADJUSTABLE NOTE A	±0.3%	±1%	N/A	U-CHANNEL CHASSIS 10.50" x 5.00" x 2.45" (266.7mm) x (127mm) x (62.23mm)
			+12V AUX 1	4A/ 6A PK	±5% NOTE C	±0.5%	±5%	±5%	
			-12V	1.5A	±4% NOTE B	±0.1%	±1%	N/A	
			-5V	1.5A	±4% NOTE B	±0.1%	±1%	N/A	
150/175	N/A	SPL175 -4000R	+5V	20A	ADJUSTABLE NOTE A	±0.3%	±1%	N/A	BOARD ONLY 8.00" x 4.00" x 2.10" (203.2mm) x (101.6mm) x (53.34mm)
			+12V	1.5A	±4% NOTE B	±0.1%	±1%	N/A	
			-5V	1.5A	±4% NOTE B	±0.1%	±1%	N/A	
			-12V	1.5A	±4% NOTE B	±0.1%	±1%	N/A	
150/175	N/A	SPL175 -4100	+5V	20A	ADJUSTABLE NOTE A	±0.3%	±1%	N/A	BOARD ONLY 8.00" x 4.00" x 2.10" (203.2mm) x (101.6mm) x (53.34mm)
			+12V	5A/ 8A PK NOTE J	±5% NOTE C	±0.5%	±3%	±5%	
			+12V	1.5A	±4% NOTE B	±0.1%	±1%	N/A	
			-12V	1.5A	±4% NOTE B	±0.1%	±1%	N/A	
150/175	N/A	SPL175 -4200	+5V	20A	ADJUSTABLE NOTE A	±0.3%	±1%	N/A	BOARD ONLY 8.00" x 4.00" x 2.10" (203.2mm) x (101.6mm) x (53.34mm)
			+24V	3A/ 5A PK NOTE J	±5% NOTE C	±0.5%	±3%	±5%	
			+12V	1.5A	±4% NOTE B	±0.1%	±1%	N/A	
			-12V	1.5A	±4% NOTE B	±0.1%	±1%	N/A	

NOTES: A. Voltage level adjustable from 4.75V to OVP trip point. Factory set to ±1% of nominal.
 B. Fully regulated output, voltage fixed (3 terminal regulator).
 C. Quasi-regulated output.
 D. Fully regulated output, voltage adjustable ±5% minimum. Factory set to ±1% of nominal.
 E. The sum of the main +5V and AUX 1 load currents must not exceed 30A.
 F. The sum of the main +5V and AUX 1 load currents must not exceed the main +5V current rating.
 G. Maximum load is 10A or 120W.
 H. Voltage level adjustable from +5V to +24V. Factory set to +12V ±1%.
 J. Total output power must be limited to 450 watts, if the main +5V output current is greater than 50A.

SPL/SWA SERIES

MULTIPLE OUTPUT MODELS

CONVECTION COOLED WATTAGE/30 CFM		MODEL	VOLTAGE	CURRENT	INITIAL SETTING TOLERANCE	LINE REGULATION	LOAD REGULATION	CROSS REGULATION	CONFIGURATION
CONTINUOUS	PEAK								
150/175	N/A	SPL175-4300	+5V	20A	ADJUSTABLE NOTE A	±0.3%	±1%	N/A	BOARD ONLY 8.00" x 4.00" x 2.10" (203.2mm) x (101.6mm) x (53.34mm)
			+12V	5A/ 8A PK NOTE J	±5% NOTE C	±0.5%	±3%	±5%	
			-12V	1.5A	±4% NOTE B	±0.1%	±1%	N/A	
			-5V	1.5A	±4% NOTE B	±0.1%	±1%	N/A	
200	250	SPL200-4000P	+5V	35A NOTE F	ADJUSTABLE NOTE A	±0.3%	±1%	N/A	FULLY REGULATED OUTPUTS U-CHANNEL CHASSIS 13.00" x 5.00" x 2.45" (330.2mm) x (127mm) x (62.23mm)
			+12V AUX 1	4A/ 7A PK	ADJUSTABLE NOTE D	±0.1%	±1%	N/A	
			-12V	1.5A	ADJUSTABLE NOTE D	±0.1%	±1%	N/A	
			-5V	1.5A	±4% NOTE D	±0.1%	±1%	N/A	
200	250	SPL200-4100P	+5V	35A NOTE F	ADJUSTABLE NOTE A	±0.3%	±1%	N/A	U-CHANNEL CHASSIS 13.00" x 5.00" x 2.45" (330.2mm) x (127mm) x (62.23mm)
			+12V AUX 1	4A/ 7A PK	±5% NOTE C	±0.5%	±3%	±3%	
			-12V	1.5A	±4% NOTE B	±0.1%	±1%	N/A	
			-5V	1.5A	±4% NOTE B	±0.1%	±1%	N/A	
200	250	SPL200-5100P	+5V	35A NOTE F	ADJUSTABLE NOTE A	±0.3%	±1%	N/A	U-CHANNEL CHASSIS 13.00" x 5.00" x 2.45" (330.2mm) x (127mm) x (62.23mm)
			+12V AUX 1	4A/ 8A PK	±5% NOTE C	±0.5%	±5%	±3%	
			+12V	1.5A	±4% NOTE B	±0.1%	±1%	N/A	
			-12V	1.5A	±4% NOTE B	±0.1%	±1%	N/A	
			-5V	1.5A	±4% NOTE B	±0.1%	±1%	N/A	
200	250	SPL200-5200P	+5V	35A NOTE F	ADJUSTABLE NOTE A	±0.3%	±1%	N/A	U-CHANNEL CHASSIS 13.00" x 5.00" x 2.45" (330.2mm) x (127mm) x (62.23mm)
			+12V AUX 1	4A/ 8A PK	±5% NOTE C	±0.5%	±5%	±3%	
			-12V	1.5A	±4% NOTE B	±0.1%	±1%	N/A	
			-5V	1.5A	±4% NOTE B	±0.1%	±1%	N/A	
			+24V	4A/ 6A PK	±5% NOTE C	±0.5%	±5%	±5%	

- NOTES:** A. Voltage level adjustable from 4.75V to OVP trip point. Factory set to ±1% of nominal.
 B. Fully regulated output, voltage fixed (3 terminal regulator).
 C. Quasi-regulated output.
 D. Fully regulated output, voltage adjustable ±5% minimum. Factory set to ±1% of nominal.
 E. The sum of the main +5V and AUX 1 load currents must not exceed 30A.
 F. The sum of the main +5V and AUX 1 load currents must not exceed the main +5V current rating.
 G. Maximum load is 10A or 120W.
 H. Voltage level adjustable from +5V to +24V. Factory set to +12V ±1%.
 J. Total output power must be limited to 450 watts, if the main +5V output current is greater than 50A.

SPL/SWA SERIES MECHANICAL DIMENSIONS

SPL40 SINGLE OUTPUT

OVERALL SIZE
5.75" x 3.93" x 1.88"
(146.05 mm) x (99.82 mm) x (42.67 mm)

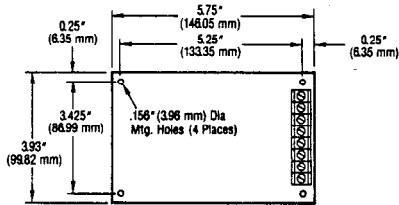

1.98"
(42.67 mm)

WEIGHT: 0.6 LBS
(0.27 kg)

SPL53 SINGLE/MULTIPLE OUTPUT

OVERALL SIZE
8.25" x 4.25" x 2.18"
(209.55 mm) x (107.95 mm) x (53.34 mm)

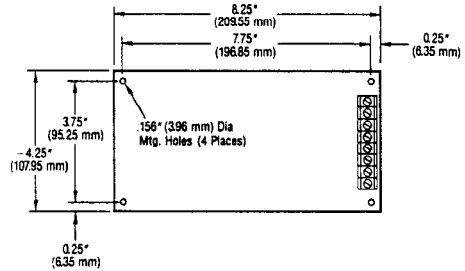

-4.25"
(107.95 mm)

2.10"
(53.34 mm)

WEIGHT: 1.3 LBS
(0.585 kg)

THE SPL53 MAY REQUIRE A RUBBER SNUBBER MOUNTED UNDER IT IN SOME APPLICATIONS TO PREVENT BOARD DEFLECTION. CONSULT FACTORY.

SPL40 MULTIPLE OUTPUT

OVERALL SIZE
6.30" x 3.92" x 2.00"
(160.00 mm) x (99.57 mm) x (50.80 mm)

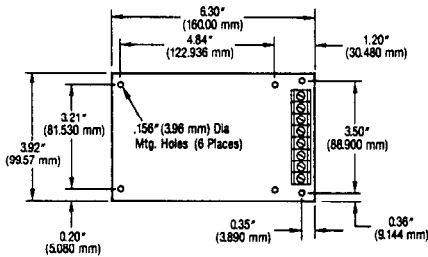

2.00"
(50.80 mm)

WEIGHT: 0.77 LBS
(0.3465 kg)

SPL130 SINGLE OUTPUT

OVERALL SIZE
8.90" x 5.00" x 2.45"
(226.06 mm) x (127.00 mm) x (62.23 mm)

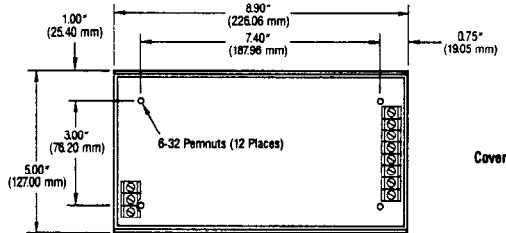

1.188"
(30.17 mm)

2.45"
(62.23 mm)

0.91"
(23.11 mm)

Cover Part #412-75717

WEIGHT: 2.5 LBS
(1.125 kg)

SPL50 MULTIPLE OUTPUT

OVERALL SIZE
6.30" x 3.92" x 1.75"
(160.00 mm) x (99.57 mm) x (44.45 mm)

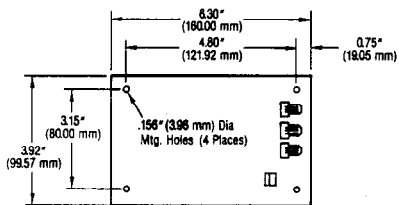

0.40"
(10.16 mm)

MATING CONNECTORS
AC INPUT: MOLEX P/N 09-50-3031
DC OUTPUT: MOLEX P/N 22-01-1043

1.75"
(44.45 mm)

WEIGHT: 0.8 LBS
(0.36 kg)

SPL130 MULTIPLE OUTPUT

OVERALL SIZE
10.50" x 5.00" x 2.45"
(266.70 mm) x (127.00 mm) x (62.23 mm)

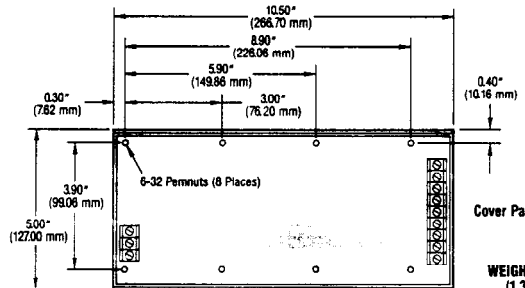

1.625"
(41.275 mm)

2.45"
(62.23 mm)

0.375"
(9.525 mm)

Cover Part #412-75873

WEIGHT: 3 LBS
(1.35 kg)

(4) Corner Holes are Mounting for Opposite Side

SPL/SWA SERIES

MECHANICAL DIMENSIONS

SPL175 MULTIPLE OUTPUT

OVERALL SIZE
8.00" x 4.00" x 2.10"
(203.20 mm) x (101.60 mm) x (53.34 mm)

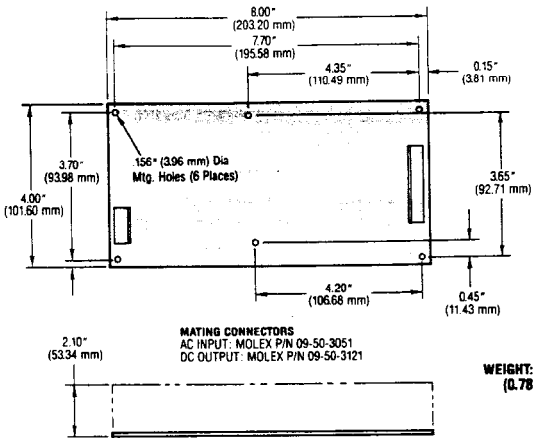

SPL250 SINGLE OUTPUT

OVERALL SIZE
12.00" x 4.94" x 2.45"
(304.80 mm) x (125.48 mm) x (62.23 mm)

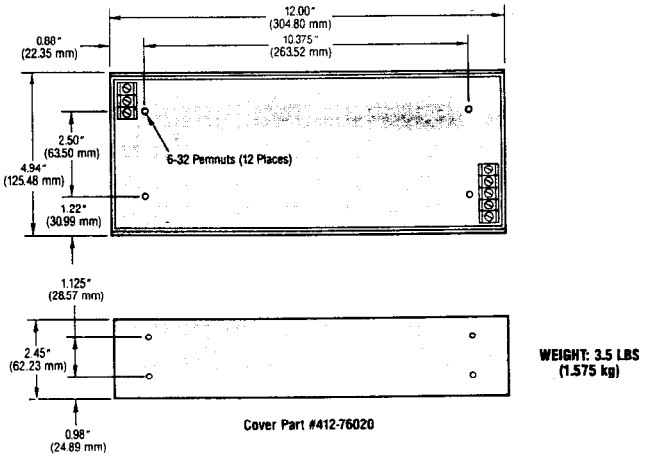

SPL200 MULTIPLE OUTPUT

OVERALL SIZE
13.00" x 5.00" x 2.45"
(330.20 mm) x (127.00 mm) x (62.23 mm)

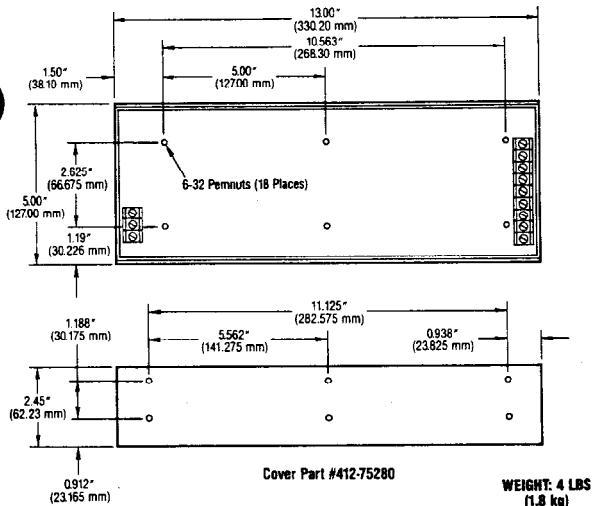

SWA125

OVERALL SIZE
9.00" x 4.75" x 2.35"
(228.60 mm) x (120.65 mm) x (59.69 mm)

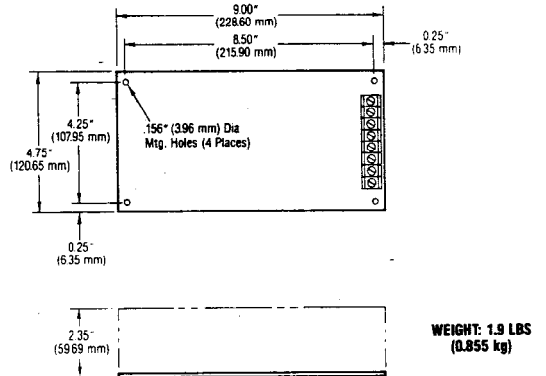

The SPL Series Is Available At Your Local Distributor.

See The Inside Rear Cover For A Listing Of Distributors Closest To You.

Your Local Value-Added Distributor Can Perform Authorized Modifications.