

SURFACE MOUNT LED AMBER, 0603 PACKAGE

BIVAR

SM0603AC

- ◆ Industry Standard 0603 Package
- ◆ RoHS Compliant
- ◆ Small Package and Footprint
- ◆ Water Clear Lens
- ◆ Wide Viewing Angle
- ◆ Ideal for Status Indication, Display, and Backlighting



Bivar Surface Mount 0603 package LED may be used in nearly any lighting or indication application. The miniature package is ideal for small scale applications such as general indication and backlighting. Low power consumption and excellent long life reliability are suitable for battery powered equipment. Bivar offers water clear LED lens for maximum luminous intensity. Wide variety of wavelength and intensity combinations are available to meet any illumination need. The SM0603 LED is packaged in standard tape and reels for pick and place assemblies.

Part Number	Material	Emitted Color	Peak Wavelength λ_p (nm) TYP.	Lens Appearance	Luminous Intensity (mcd) TYP.	Viewing Angle
SM0603AC	GaAsP	AMBER	610	Water Clear	7.2	130°

Outline Dimensions

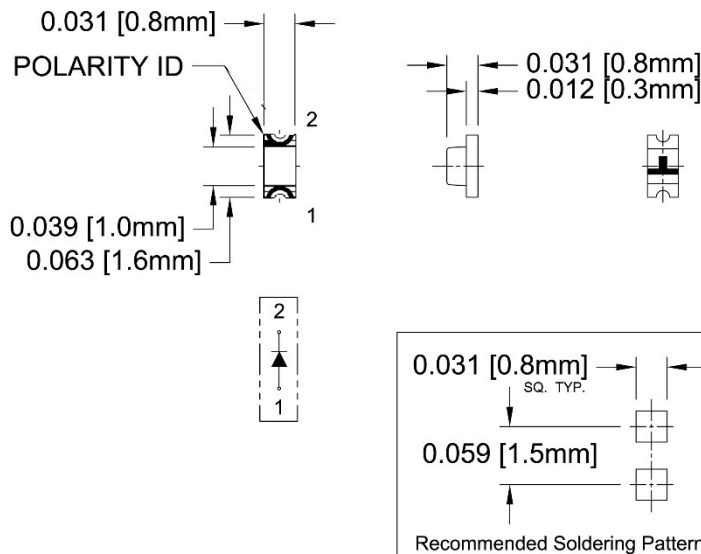

Outline Drawings Notes:

1. All dimensions are in inches [millimeters].
2. Standard tolerance: ± 0.010 " unless otherwise noted.



Bivar reserves the right to make changes at any time without notice.

Absolute Maximum Ratings

T_A = 25°C unless otherwise noted

Power Dissipation	78 mW
Forward Current (DC)	30 mA
Peak Forward Current ¹	100 mA
Reverse Voltage	5 V
Operating Temperature Range	-40 - +85°C
Storage Temperature Range	-40 - +85°C
Lead Soldering Temperature (3 mm from the base of the epoxy bulb) ²	260°C

Notes: 1. 10% Duty Cycle, Pulse Width ≤ 0.1 msec. 2. Solder time less than 5 seconds at temperature extreme.

Electrical / Optical Characteristics

T_A = 25°C & I_F = 20 mA unless otherwise noted

Part Number	Forward Voltage (V) ¹			Recommend Forward Current (mA)			Reverse Current (μA)	Dominant Wavelength (nm) ²			Luminous Intensity I _v (mcd) ³			Viewing Angle 2 Θ ½ (deg)
	MIN	TYP	MAX	MIN	TYP	MAX	MAX	MIN	TYP	MAX	MIN	TYP	MAX	TYP
SM0603AC	1.8	2.0	2.6	/	20	/	10	/	606	/	3.6	7.2	11.5	130

Notes: 1. Tolerance of forward voltage : ±0.05V. 2. Tolerance of dominant wavelength : ±1.0nm. 3. Tolerance of luminous intensity : ±10%

Typical Electrical / Optical Characteristics

$T_A = 25^\circ\text{C}$ unless otherwise noted

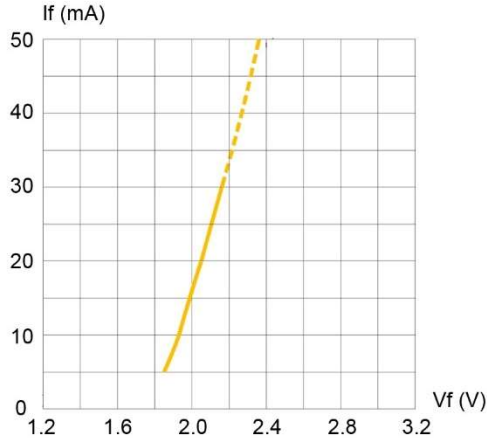

Fig. 1 Forward Current vs. Forward Voltage

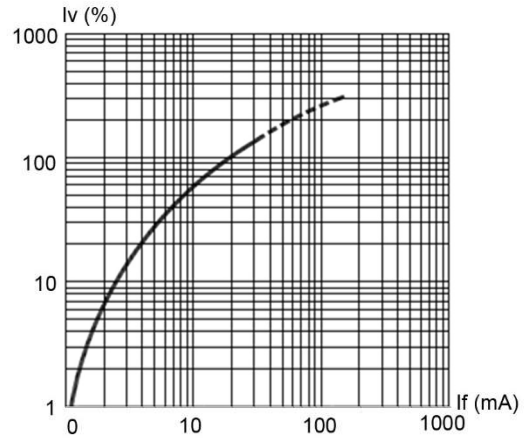

Fig. 2 Relative Luminous Intensity vs. Forward Current

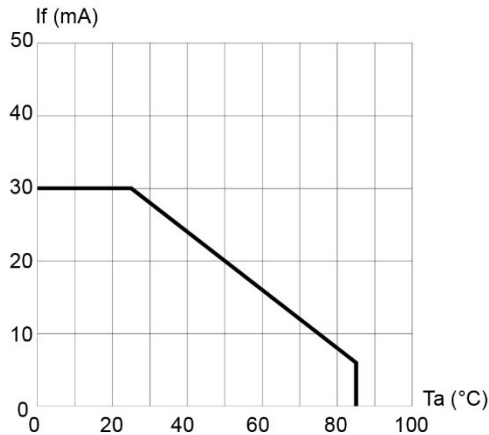

Fig. 3 Forward Current vs. Temperature

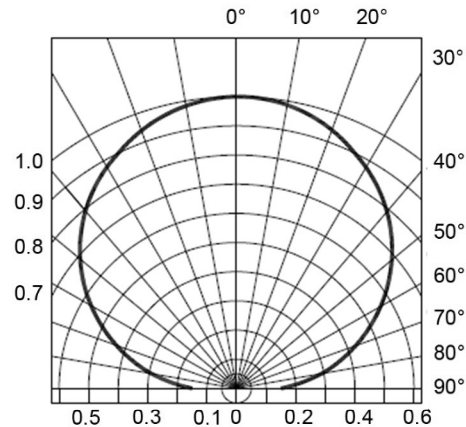

Fig. 4 Directivity Radiation Diagram

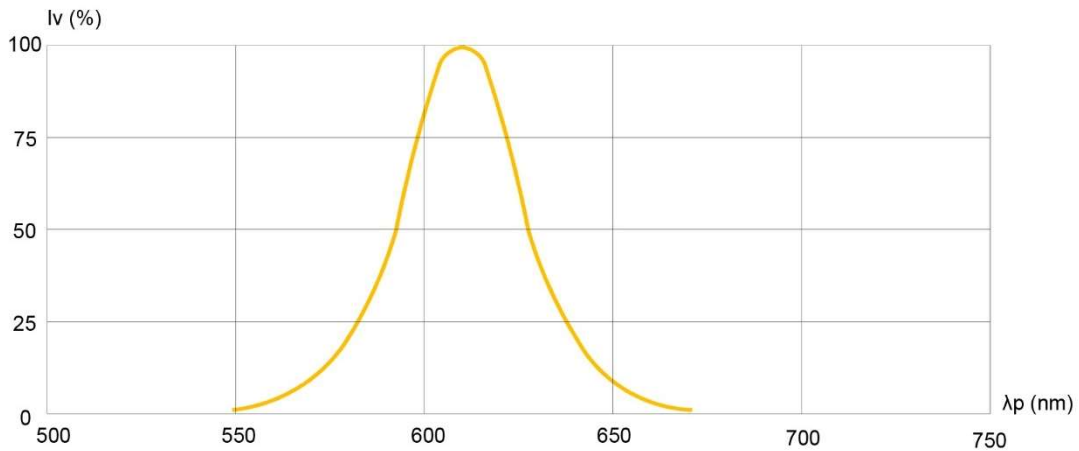
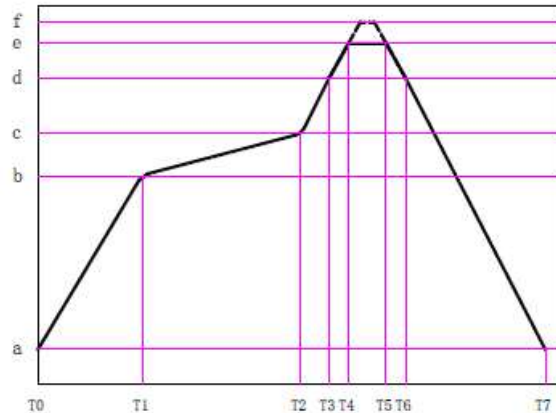

Fig. 5 Relative Luminous Intensity vs. Peak Wavelength

Bivar reserves the right to make changes at any time without notice.

Recommended Soldering Conditions

Temp. (°C)	Time		
a 25	T0~T1	Max. 3°C/sec	
b 150	T1~T2	90~130 sec	
c 200	T2~T4	Max. 3°C/sec	
d 220	T3~T6	Max. 50 sec	
e 245			
f Max. 260		Max. 10 sec	
	T5~T7	Max. -3°C/sec	
Belt Speed	70~90 cm/min		



Soldering Iron

1. Temperature at tip of iron: 300°C Max. (25W Max.)
2. Soldering time: 5 ± 1 sec.

Precautions For Use

1. Customer must apply resistors for protection and stability. Using Circuit B in the diagram below is recommended. Using Circuit A can result in LED burnout.

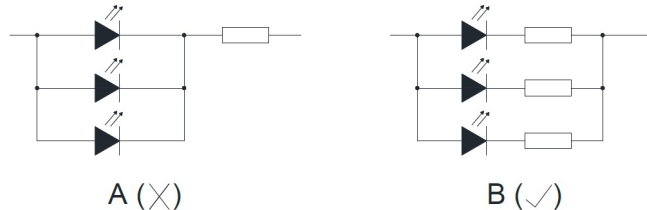

2. Current change may lead to LED color change. If there is a large difference between the spectral color separation current and actual service current, a color difference may occur.
3. Utilize forward current for LED operation. Subjecting the LED to continuous reverse voltage may cause damage to the die.

Handling Precautions

1. When handling the product with tweezers, be careful to not damage the resin. The resin can be cut, chipped, delaminated, or deformed, which can lead to wire-bond breaks.

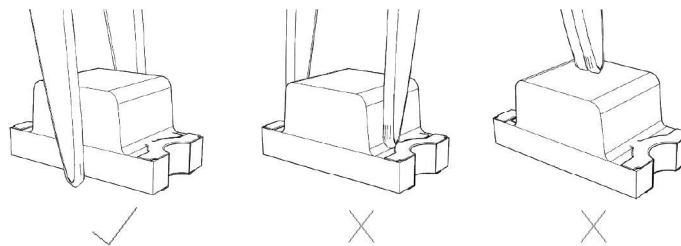

2. Reflow soldering must not be performed more than twice. Hand soldering must not be performed more than once.
3. When soldering, do not put stress on the LEDs during heating.
4. LEDs are sensitive to static electricity or voltage surges. ESD can damage a die and its reliability.
5. Do not stack assembled PCBs together. When stacked, PCBs with soldered LEDs can damage the resin surrounding the die, leading to failure.

Bivar reserves the right to make changes at any time without notice.

SURFACE MOUNT LED AMBER, 0603 PACKAGE



Storage

1. The storage temperature and R.H. are 5 °C ~30 °C, R.H. 60% Max.
2. Once the package is opened, the products should be used within 72 hrs. Otherwise, they should be kept in a dampproof box with a desiccating agent. Considering the tape life, we suggest using the product 1 year of production date.
3. It's recommended to bake at 70 °C ± 5 °C for 24 hrs before soldering them after the package is unsealed for 72 hrs.

Tape and Reel Dimensions

Note: 4000 pcs/Reel

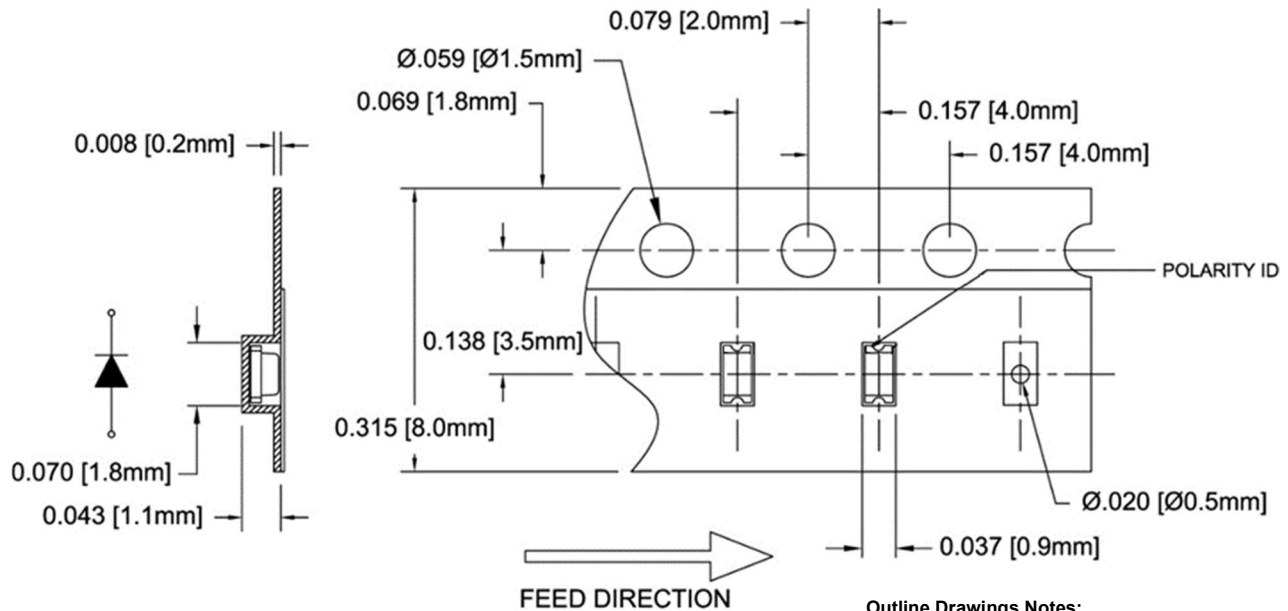

Bivar reserves the right to make changes at any time without notice.

SURFACE MOUNT LED AMBER, 0603 PACKAGE

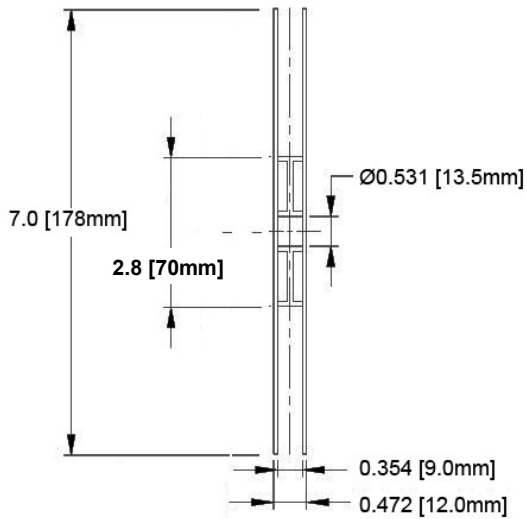
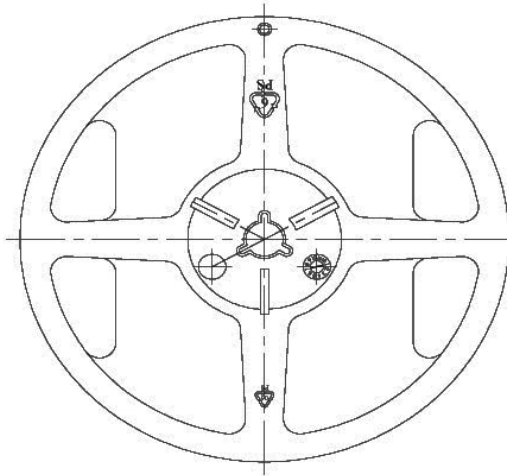

Outline Drawings Notes:

1. All dimensions are in inches [millimeters].
2. Standard tolerance unless otherwise noted: X.XXX ± 0.010"
X.X ± 0.1"

Packaging and Labeling Plan

Note: 1 Reel / Bag

Vacuum and Heat Sealed
Clear AntiStatic Poly Bag

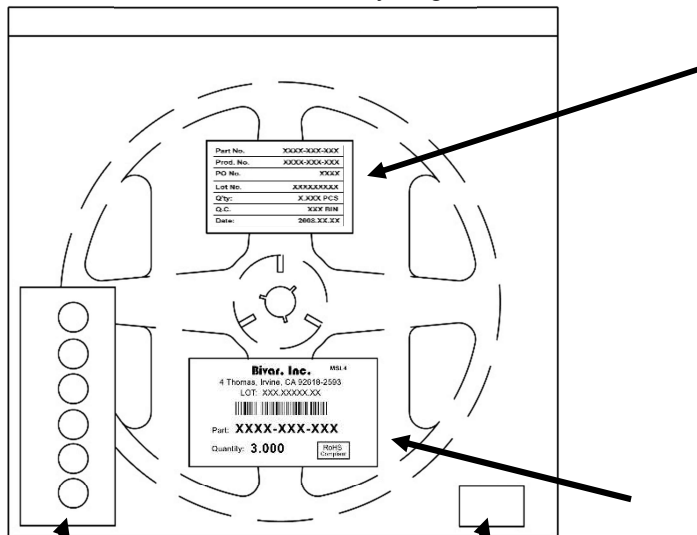

Humidity Indicator
Card

Desiccant

Part No.	XXXX-XXX-XXX
Prod. No.	XXXX-XXX-XXX
PO No.	XXXX
Lot No.	XXXXXXXXXX
Q'ty:	X.XXX PCS
Q.C.	XXX BIN
Date:	2008.XX.XX

Internal Quality Control
Label



Bivar Standard Packaging Label

Bivar reserves the right to make changes at any time without notice.