



IR Emitter and Detector Product Data Sheet

LTE-3271BL

Spec No.: DS50-2003-020

Effective Date: 04/28/2004

Revision: A

LITE-ON DCC

RELEASE

BNS-OD-FC001/A4

FEATURES

- * SPECIAL FOR HIGH CURRENT AND LOW FORWARD VOLTAGE
- * HIGH POWER
- * AVAILABLE FOR PULSE OPERATING
- * WIDE VIEWING ANGLE
- * BLUE TRANSPARENT COLOR PACKAGE
- * AMMO PACK
- * TIN DIPPING LEADS

PACKAGE DIMENSIONS

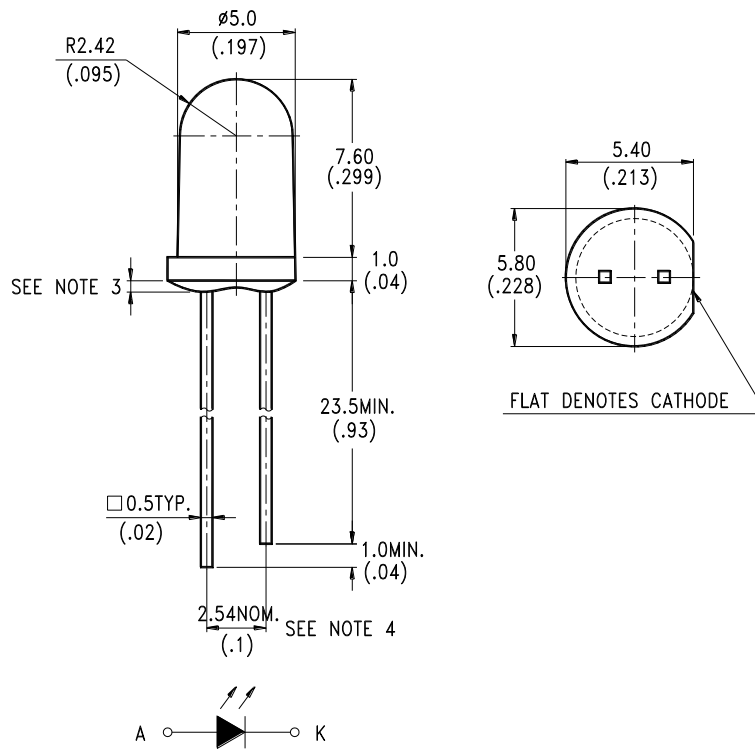

NOTES:

1. All dimensions are in millimeters (inches).
2. Tolerance is $\pm 0.25\text{mm}$ (.010") unless otherwise noted.
3. Protruded resin under flange is 1.5mm (.059") max.
4. Lead spacing is measured where the leads emerge from the package.
5. Specifications are subject to change without notice.



LITE-ON TECHNOLOGY CORPORATION.

Property of Lite-On Only

ABSOLUTE MAXIMUM RATINGS AT TA=25°C

PARAMETER	MAXIMUM RATING	UNIT
Power Dissipation	150	mW
Peak Forward Current (300pps, 10 μs pulse)	2	A
Continuous Forward Current	100	mA
Reverse Voltage	5	V
Operating Temperature Range	-40°C to + 85°C	
Storage Temperature Range	-55°C to + 100°C	
Lead Soldering Temperature [1.6mm(.063") From Body]	260°C for 5 Seconds	

ELECTRICAL OPTICAL CHARACTERISTICS AT TA=25°C

PARAMETER	SYMBOL	MIN.	TYP.	MAX.	UNIT	TEST CONDITION	BIN GRADE
Radiant Intensity	IE	30			mW/sr	IF = 100mA	BIN B
		44			mW/sr	IF = 100mA	BIN C
		52			mW/sr	IF = 100mA	BIN D
		62			mW/sr	IF = 100mA	BIN E
Peak Emission Wavelength	λP		940		nm	IF = 20mA	
Spectral Line Half-Width	Δλ		50		nm	IF = 20mA	
Forward Voltage	VF		1.25	1.6	V	IF = 50mA	
Forward Voltage	VF		1.85	2.3	V	IF = 500mA	
Reverse Current	IR			100	μA	VR = 5V	
Viewing Angle (See FIG.6)	2θ1/2		50		deg.		

TYPICAL ELECTRICAL / OPTICAL CHARACTERISTICS CURVES

(25°C Ambient Temperature Unless Otherwise Noted)

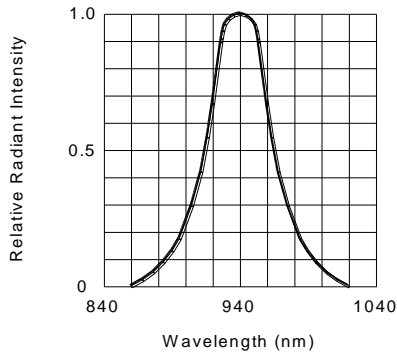

FIG.1 SPECTRAL DISTRIBUTION

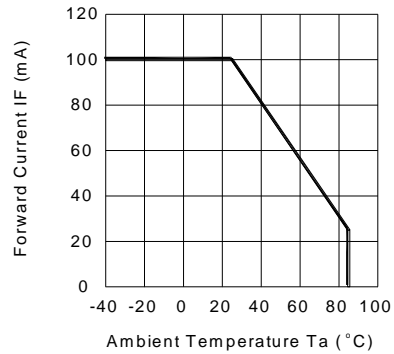

FIG.2 FORWARD CURRENT VS. AMBIENT TEMPERATURE

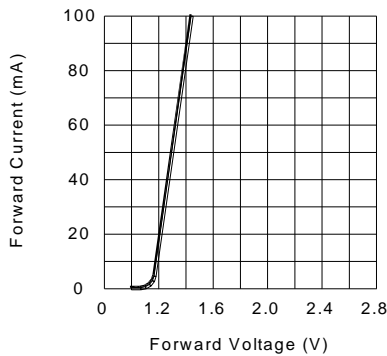

FIG.3 FORWARD CURRENT VS. FORWARD VOLTAGE

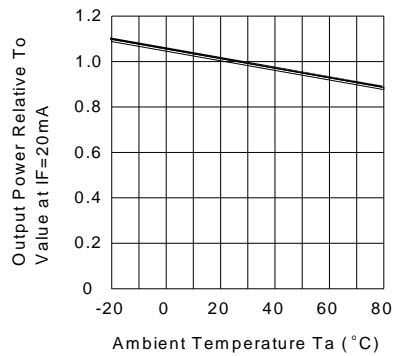

FIG.4 RELATIVE RADIANT INTENSITY VS. AMBIENT TEMPERATURE

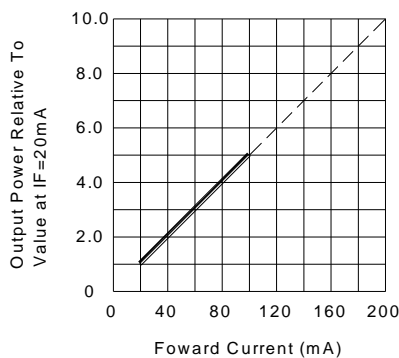

FIG.5 RELATIVE RADIANT INTENSITY VS. FORWARD CURRENT

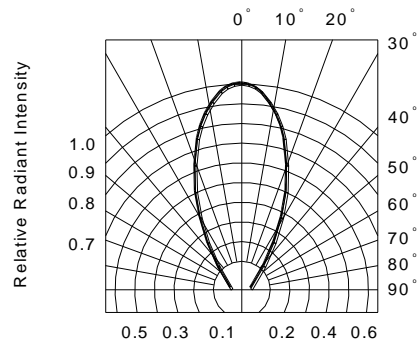

FIG.6 RADIATION DIAGRAM