

Dimensions: [mm]

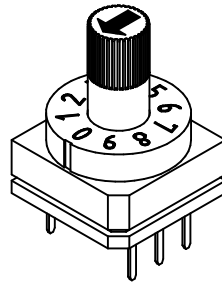

Scale - 2:1

Recommended Hole Pattern: [mm]

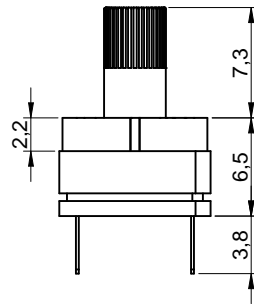
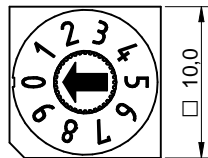
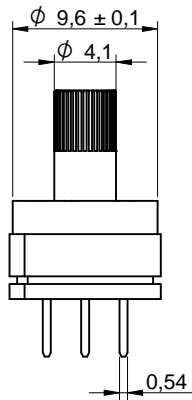
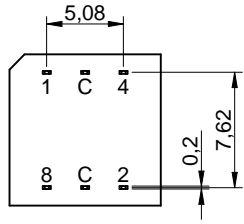
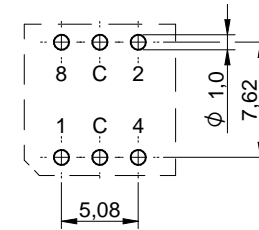

Scale - 2:1

Code:

		Real Code					
		C	1	2	4	8	
10 Position	0	•				0	
	1	•	•			1	
	2	•		•		2	
	3	•	•	•		3	
	4	•			•	4	
	5	•	•		•	5	
	6	•		•	•	6	
	7	•	•	•	•	7	
	8	•				•	8
	9	•	•			•	9



Würth Elektronik eiSos GmbH & Co. KG
 EMC & Inductive Solutions
 Max-Eyth-Str. 1
 74638 Waldenburg
 Germany
 Tel. +49 (0) 79 42 945 - 0
 www.we-online.com
 eiSos@we-online.com

CHECKED ICh	REVISION 001.002	DATE (YYYY-MM-DD) 2021-04-13	GENERAL TOLERANCE DIN ISO 2768-1m	PROJECTION METHOD
DESCRIPTION WS-ROTV THT IP67 Rotary Switch			ORDER CODE 428527420910	
SIZE/TYPE 10x10 mm with Shaft type Actuator		BUSINESS UNIT eiCan	STATUS Valid	PAGE 1/8

Material Properties:

Cover Material	PA66
Cover Flammability Rating	UL94 V-0
Cover Color	Light Grey
Actuator Material	POM
Actuator Flammability Rating	UL94 HB
Actuator Color	Dark Grey
Base Material	PA66
Base Flammability Rating	UL94 V-0
Base Color	Black
Contact Material	Copper Alloy
Contact Plating	Gold
Terminal Material	Copper Alloy
Terminal Plating	Gold

Electrical Properties:

Properties	Test conditions	Value	Unit	Tol.
Rated Current Switching	I_R	150	mA	
Rated Voltage Switching	V_R	24	V (DC)	
Rated Current Non-Switching	I_R	400	mA	
Rated Voltage Non-Switching	V_R	24	V (DC)	
Contact Resistance Initial	R	80	m Ω	max.
Contact Resistance After Life Test	R	200	m Ω	max.
Insulation Resistance	R_{ISO} 250 V (DC)	100	M Ω	min.
Withstanding Voltage	1 min	250	V (AC)	

Mechanical Properties:

Properties	Test conditions	Value	Unit	Tol.
Operation Force		700	g	max.

Mechanical Properties:



Properties	Test conditions	Value	Unit	Tol.
Electrical Life	150 mA/ 24 V (DC)	10000	Steps	
Actuator Type	Shaft Type			
Number of Position	10			
Code	Real Code			

General Information:

Operating Temperature	-40 up to +85 °C
Storage Conditions (in original packaging)	< 40 °C ; < 75 % RH
Moisture Sensitivity Level (MSL)	1
Washable	Yes
Ingress Protection Code	IP67

Certification:

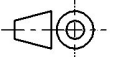
RoHS Approval	Compliant [2011/65/EU&2015/863]
REACH Approval	Conform or declared [(EC)1907/2006]
Halogen Free	Conform [IEC 61249-2-21]
Halogen Free	Conform [JEDEC JS709B]

	CHECKED ICh	REVISION 001.002	DATE (YYYY-MM-DD) 2021-04-13	GENERAL TOLERANCE DIN ISO 2768-1m	PROJECTION METHOD 
	DESCRIPTION WS-ROTV THT IP67 Rotary Switch				ORDER CODE 428527420910
	Würth Elektronik eiSos GmbH & Co. KG EMC & Inductive Solutions Max-Eyth-Str. 1 74638 Waldenburg Germany Tel. +49 (0) 79 42 945 - 0 www.we-online.com eiSos@we-online.com			BUSINESS UNIT eiCan	PAGE 2/8
	SIZE/TYPE 10x10 mm with Shaft type Actuator	STATUS Valid			

Packaging Specification - Tube: [mm]

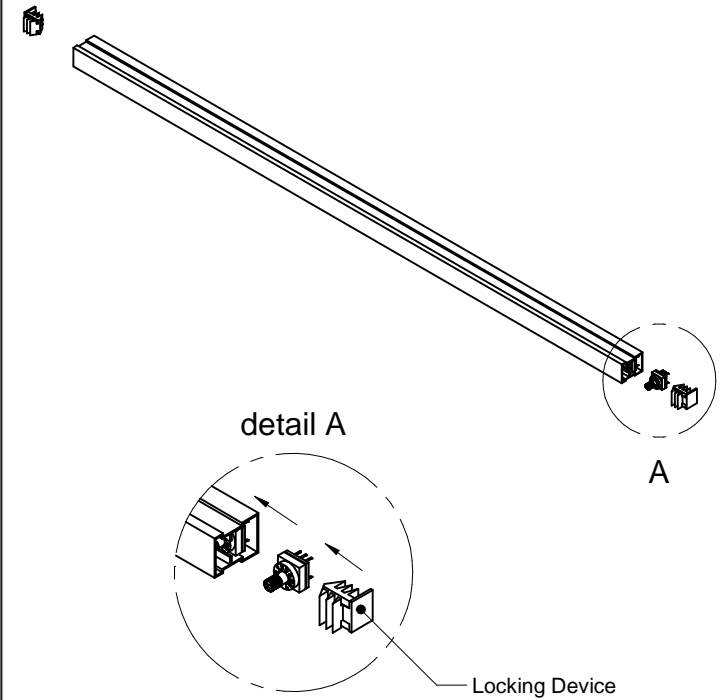
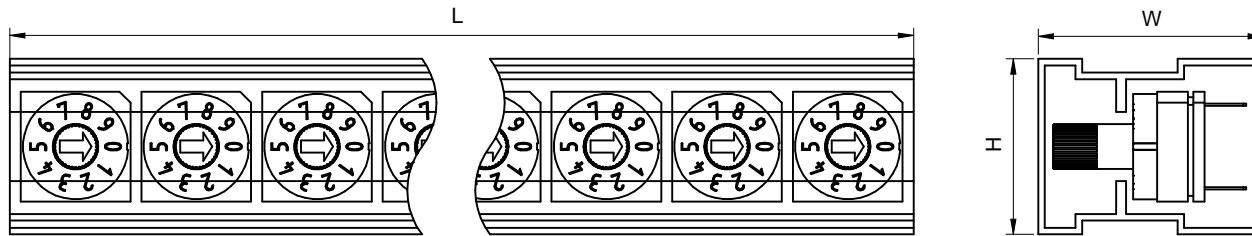

	L _c (mm)	W _c (mm)	H _c (mm)	No. of Locking Device (pcs.)	Qty. (pcs.)	Material
Tolerance	typ.	typ.	typ.			
Value	540,00	16,00	20,50	2	50	PVC



Würth Elektronik eiSos GmbH & Co. KG
 EMC & Inductive Solutions
 Max-Eyth-Str. 1
 74638 Waldenburg
 Germany
 Tel. +49 (0) 79 42 945 - 0
 www.we-online.com
 eiSos@we-online.com

CHECKED	REVISION	DATE (YYYY-MM-DD)	GENERAL TOLERANCE	PROJECTION METHOD
ICb	001.002	2021-04-13	DIN ISO 2768-1m	
DESCRIPTION			ORDER CODE	
WS-ROTV THT IP67 Rotary Switch			428527420910	
SIZE/TYPE		BUSINESS UNIT	STATUS	PAGE
10x10 mm with Shaft type Actuator		eiCan	Valid	3/8

Packaging Specification - Inner Carton: [mm]

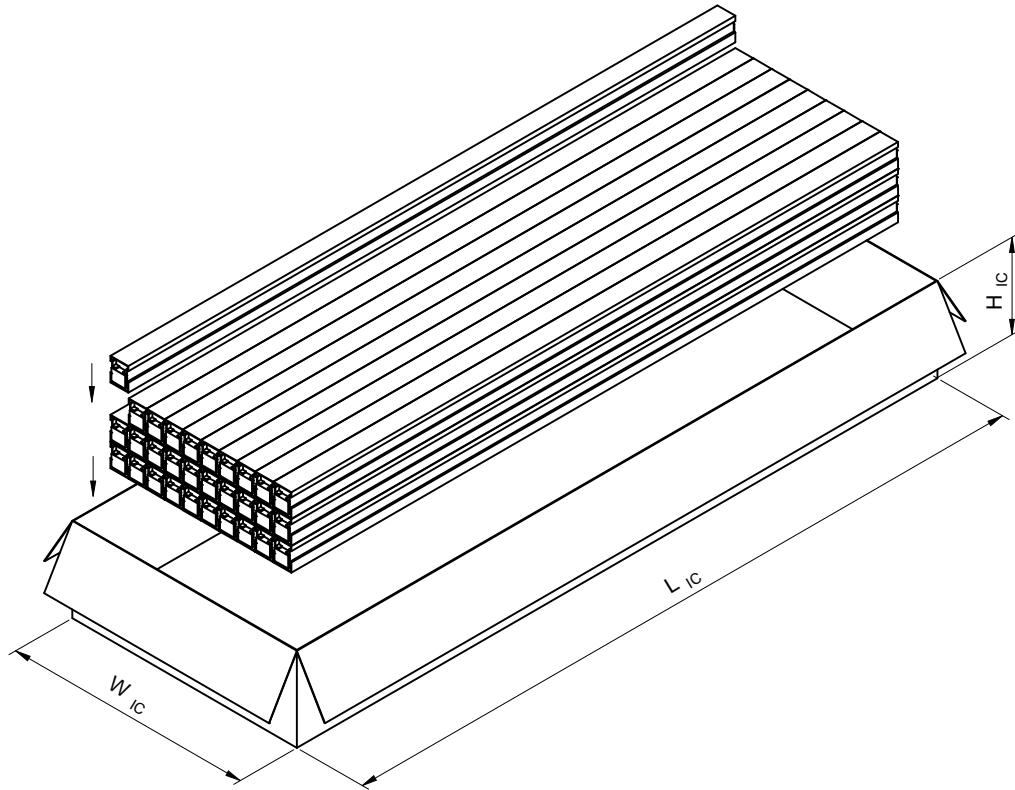

	L _c (mm)	W _c (mm)	H _c (mm)	No. of Tube (pcs.)	Qty. (pcs.)	Material
Tolerance	typ.	typ.	typ.			
Value	570,00	200,00	75,00	30	1500	Paper

Packaging Specification - Outer Carton: [mm]

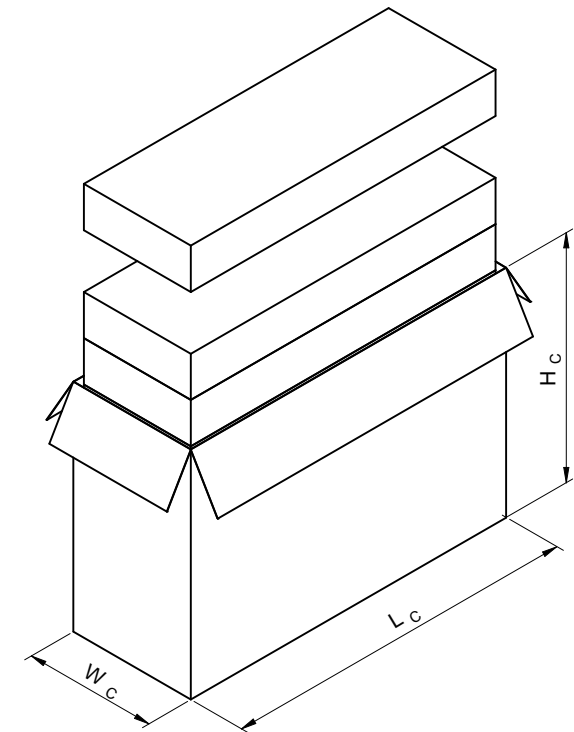

	L _c (mm)	W _c (mm)	H _c (mm)	No. of Inner Carton (pcs.)	Qty. (pcs.)	Material
Tolerance	typ.	typ.	typ.			
Value	590,00	220,00	405,00	5	7500	Paper



Würth Elektronik eiSos GmbH & Co. KG
 EMC & Inductive Solutions
 Max-Eyth-Str. 1
 74638 Waldenburg
 Germany
 Tel. +49 (0) 79 42 945 - 0
 www.we-online.com
 eiSos@we-online.com

CHECKED ICh	REVISION 001.002	DATE (YYYY-MM-DD) 2021-04-13	GENERAL TOLERANCE DIN ISO 2768-1m	PROJECTION METHOD
DESCRIPTION WS-ROTV THT IP67 Rotary Switch			ORDER CODE 428527420910	
SIZE/TYPE 10x10 mm with Shaft type Actuator		BUSINESS UNIT eiCan	STATUS Valid	PAGE 4/8

Classification Wave Soldering Profile:



Classification Wave Soldering Profile:

Profile Feature		Pb-Free Assembly	Sn-Pb Assembly
Preheat Temperature Min	$T_{s \min}$	100 °C	100 °C
Preheat Temperature Typical	$T_{s \text{ typical}}$	120 °C	120 °C
Preheat Temperature Max	$T_{s \max}$	130 °C	130 °C
Preheat Time t_s from $T_{s \min}$ to $T_{s \max}$	t_s	70 seconds	70 seconds
Ramp-up Rate	ΔT	150 °C max.	150 °C max.
Peak Temperature	T_p	250 °C - 260 °C	235 °C - 260 °C
Time of actual peak temperature	t_p	max. 10 seconds max. 5 seconds each wave	max. 10 seconds max. 5 seconds each wave
Ramp-down Rate, Min		~ 2 K/ second	~ 2 K/ second
Ramp-down Rate, Typical		~ 3.5 K/ second	~ 3.5 K/ second
Ramp-down Rate, Max		~ 5 K/ second	~ 5 K/ second
Time 25 °C to 25 °C		4 minutes	4 minutes

refer to EN61760-1:2006

	CHECKED	REVISION	DATE (YYYY-MM-DD)	GENERAL TOLERANCE	PROJECTION METHOD
	ICh	001.002	2021-04-13	DIN ISO 2768-1m	
	DESCRIPTION				ORDER CODE
	WS-ROTV THT IP67 Rotary Switch				428527420910
SIZE/TYPE			BUSINESS UNIT	STATUS	PAGE
10x10 mm with Shaft type Actuator			eiCan	Valid	5/8

Cautions and Warnings:

The following conditions apply to all goods within the product series of Rotary switch of Würth Elektronik eiSos GmbH & Co. KG:

General:

- This mechanical component is designed and manufactured for use in general electronic equipment.
- Würth Elektronik must be asked for written approval (following the PPAP procedure) before incorporating the components into any equipment in fields such as military, aerospace, aviation, nuclear control, submarine, transportation (automotive control, train control, ship control), transportation signal, disaster prevention, medical, public information network, etc. where higher safety and reliability are especially required and/or if there is the possibility of direct damage or human injury.
- Mechanical components that will be used in safety-critical or high-reliability applications, should be pre-evaluated by the customer.
- The component is designed and manufactured to be used within the datasheet specified values. If the usage and operation conditions specified in the datasheet are not met, the component may be damaged or dissolved.
- Do not drop or impact the components, the component may flake apart.
- Prevent any damage or scratches on the switch, especially on the actuator.
- Würth Elektronik products are qualified according to international standards, which are listed in each product reliability report. Würth Elektronik does not warrant any customer qualified product characteristics beyond Würth Elektronik's specifications, for its validity and sustainability over time.
- The responsibility for the applicability of the customer specific products and use in a particular customer design is always within the authority of the customer. All technical specifications for standard products also apply to customer specific products.

Product Specific:

Soldering:

- The solder profile must comply with the technical product specifications. All other profiles will void the warranty.
- All other soldering methods are at the customers' own risk.
- Please keep our switch at delivery original position before and during the soldering process.
- Design the right angle part with consideration of the wave soldering process so that the parts will not touch the soldering wave during the soldering process or protect the switch part with cover fixture. Melt of the switch might cause malfunction.

Cleaning and Washing:

- If a series is washable, the general information section in the datasheet will contain the washability guidelines. Should there be no information regarding washability, the product has not been constructed to withstand a washing process. Washing agents used during the production to clean the customer application might damage or change the characteristics of the component, body, pins and/or termination. Washing agents may have a negative effect on the long-term functionality of the product.

If the parts are washable, hermetic:

- Cleaning agents used to clean the customers' applications, may damage or change the characteristics of the component, body, pins and termination.
- Please do not immerse any washable products into water or cleaning agents or put them in locations exposed to water completely.
- Do not clean washable series immediately after soldering. The cleaning agent may be absorbed into the switch through respiration while the switch cools.
- Using a brush during the cleaning process could deform function relevant areas. Therefore, we do not recommend using a brush during the PCB cleaning process.

Potting and Coating:

- If the product is potted in the customer application, the potting material might shrink or expand during and after hardening. Shrinking could lead to an incomplete seal, allowing contaminants into the component. Expansion could damage the component. We recommend a manual inspection after potting or coating to avoid these effects.

Storage Conditions:



- A storage of Würth Elektronik products for longer than 12 months is not recommended. Within other effects, the terminals may suffer degradation, resulting in bad solderability. Therefore, all products shall be used within the period of 12 months based on the day of shipment.
- Do not expose the components into direct sunlight.
- The storage conditions in the original packaging are defined according to DIN EN 61760-2.
- For a moisture sensitive component, the storage condition in the original packaging is defined according to IPC/JEDEC-J-STD-033. It is also recommended to return the component to the original moisture proof bag and reseal the moisture proof bag again.
- The storage conditions stated in the original packaging apply to the storage time and not to the transportation time of the components.

Packaging:

- The packaging specifications apply only to purchase orders comprising whole packaging units. If the ordered quantity exceeds or is lower than the specified packaging unit, packaging in accordance with the packaging specifications cannot be ensured.

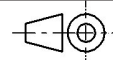

Handling:

- In the case a product requires particular handling precautions, in addition to the general recommendations mentioned here, these will appear on the product datasheet.
- Do not repeatedly operate the switch with excessive force. It may damage or deform the switch, resulting in malfunction.
- It is recommended to cool down the PCB or parts before setting the positions.
- For setting of the position, we recommend to use a screwdriver, the designated segment wheel or spindles for operation.
- The accessory shall be mounted with the cut-out in line with the positioning arrow of the rotary switch.

	CHECKED	REVISION	DATE (YYYY-MM-DD)	GENERAL TOLERANCE	PROJECTION METHOD	
	ICb	001.002	2021-04-13	DIN ISO 2768-1m		
	DESCRIPTION				ORDER CODE	
	WS-ROTV THT IP67 Rotary Switch				428527420910	
SIZE/TYPE			BUSINESS UNIT	STATUS	PAGE	
10x10 mm with Shaft type Actuator			eiCan	Valid	6/8	

- The accessory (e.g. segment wheel / spindle) is not made out of a high temperature resistant material. Therefore, it is recommended to be mounted after the soldering process.
- For switch products, we do not recommend to stack PCB's, in order to avoid malfunction of the switch.
- The temperature rise of the component must be taken into consideration. The operating temperature is comprised of ambient temperature and temperature rise of the component. The operating temperature of the component shall not exceed the maximum temperature specified.

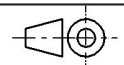
These cautions and warnings comply with the state of the scientific and technical knowledge and are believed to be accurate and reliable. However, no responsibility is assumed for inaccuracies or incompleteness.

	CHECKED	REVISION	DATE (YYYY-MM-DD)	GENERAL TOLERANCE	PROJECTION METHOD	
	ICh	001.002	2021-04-13	DIN ISO 2768-1m		
	DESCRIPTION				ORDER CODE	
	WS-ROTV THT IP67 Rotary Switch				428527420910	
Würth Elektronik eiSos GmbH & Co. KG EMC & Inductive Solutions Max-Eyth-Str. 1 74638 Waldenburg Germany Tel. +49 (0) 79 42 945 - 0 www.we-online.com eiSos@we-online.com			SIZE/TYPE	BUSINESS UNIT	STATUS	PAGE
			10x10 mm with Shaft type Actuator	eiCan	Valid	7/8

Important Notes

The following conditions apply to all goods within the product range of Würth Elektronik eiSos GmbH & Co. KG:

1. General Customer Responsibility

Some goods within the product range of Würth Elektronik eiSos GmbH & Co. KG contain statements regarding general suitability for certain application areas. These statements about suitability are based on our knowledge and experience of typical requirements concerning the areas, serve as general guidance and cannot be estimated as binding statements about the suitability for a customer application. The responsibility for the applicability and use in a particular customer design is always solely within the authority of the customer. Due to this fact it is up to the customer to evaluate, where appropriate to investigate and decide whether the device with the specific product characteristics described in the product specification is valid and suitable for the respective customer application or not.

2. Customer Responsibility related to Specific, in particular Safety-Relevant Applications

It has to be clearly pointed out that the possibility of a malfunction of electronic components or failure before the end of the usual lifetime cannot be completely eliminated in the current state of the art, even if the products are operated within the range of the specifications. In certain customer applications requiring a very high level of safety and especially in customer applications in which the malfunction or failure of an electronic component could endanger human life or health it must be ensured by most advanced technological aid of suitable design of the customer application that no injury or damage is caused to third parties in the event of malfunction or failure of an electronic component. Therefore, customer is cautioned to verify that data sheets are current before placing orders. The current data sheets can be downloaded at www.we-online.com.

3. Best Care and Attention

Any product-specific notes, cautions and warnings must be strictly observed. Any disregard will result in the loss of warranty.

4. Customer Support for Product Specifications

Some products within the product range may contain substances which are subject to restrictions in certain jurisdictions in order to serve specific technical requirements. Necessary information is available on request. In this case the field sales engineer or the internal sales person in charge should be contacted who will be happy to support in this matter.

5. Product R&D

Due to constant product improvement product specifications may change from time to time. As a standard reporting procedure of the Product Change Notification (PCN) according to the JEDEC-Standard inform about minor and major changes. In case of further queries regarding the PCN, the field sales engineer or the internal sales person in charge should be contacted. The basic responsibility of the customer as per Section 1 and 2 remains unaffected.

6. Product Life Cycle

Due to technical progress and economical evaluation we also reserve the right to discontinue production and delivery of products. As a standard reporting procedure of the Product Termination Notification (PTN) according to the JEDEC-Standard we will inform at an early stage about inevitable product discontinuance. According to this we cannot guarantee that all products within our product range will always be available. Therefore it needs to be verified with the field sales engineer or the internal sales person in charge about the current product availability expectancy before or when the product for application design-in disposal is considered. The approach named above does not apply in the case of individual agreements deviating from the foregoing for customer-specific products.

7. Property Rights

All the rights for contractual products produced by Würth Elektronik eiSos GmbH & Co. KG on the basis of ideas, development contracts as well as models or templates that are subject to copyright, patent or commercial protection supplied to the customer will remain with Würth Elektronik eiSos GmbH & Co. KG. Würth Elektronik eiSos GmbH & Co. KG does not warrant or represent that any license, either expressed or implied, is granted under any patent right, copyright, mask work right, or other intellectual property right relating to any combination, application, or process in which Würth Elektronik eiSos GmbH & Co. KG components or services are used.

8. General Terms and Conditions

Unless otherwise agreed in individual contracts, all orders are subject to the current version of the "General Terms and Conditions of Würth Elektronik eiSos Group", last version available at www.we-online.com.

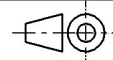
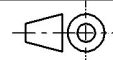
	CHECKED	REVISION	DATE (YYYY-MM-DD)	GENERAL TOLERANCE	PROJECTION METHOD	
	ICb	001.002	2021-04-13	DIN ISO 2768-1m		
	DESCRIPTION				ORDER CODE	
	WS-ROTV THT IP67 Rotary Switch				428527420910	
Würth Elektronik eiSos GmbH & Co. KG EMC & Inductive Solutions Max-Eyth-Str. 1 74638 Waldenburg Germany Tel. +49 (0) 79 42 945 - 0 www.we-online.com eiSos@we-online.com			SIZE/TYPE	BUSINESS UNIT	STATUS	PAGE
			10x10 mm with Shaft type Actuator	eiCan	Valid	8/8