

NHD-4.3-480272MF-ATXI#-CTP-1

TFT (Thin-Film-Transistor) Color Liquid Crystal Display Module

NHD-	Newhaven Display
4.3-	4.3" Diagonal
480272-	480xRGBx272 pixels
MF-	Model
A-	Built-in driver / NO Controller
T-	White LED backlight
X-	TFT
I-	6:00 viewing angle, Wide Temp
#	RoHS Compliant
CTP-1	Capacitive touch panel with controller

Newhaven Display International, Inc.

2511 Technology Drive, Suite 101

Elgin IL, 60124

Ph: 847-844-8795

Fax: 847-844-8796

www.newhavendisplay.com

nhtech@newhavendisplay.com

nhsales@newhavendisplay.com

Document Revision History

Revision	Date	Description	Changed by
0	2/1/2012	Initial Release	SB

Functions and Features

- 480xRGBx272 resolution, up to 16.7M colors
- 12-LED backlight
- 24 bit RGB interface
- Capacitive Touch Panel with Controller

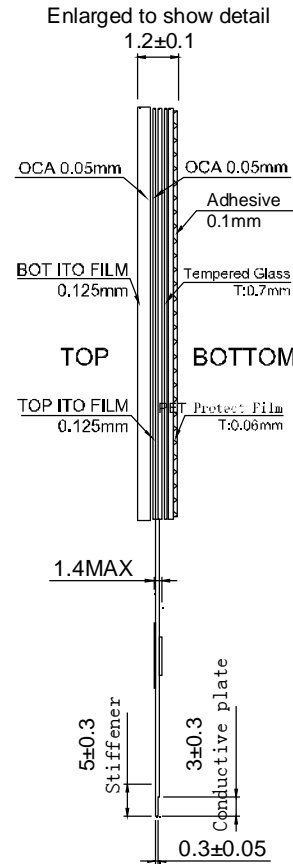
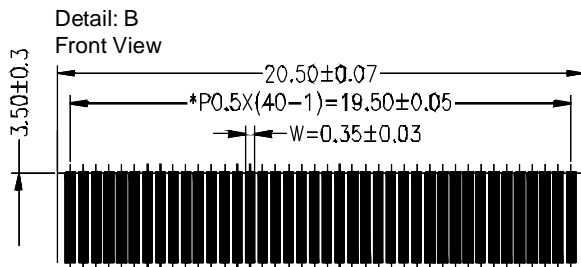
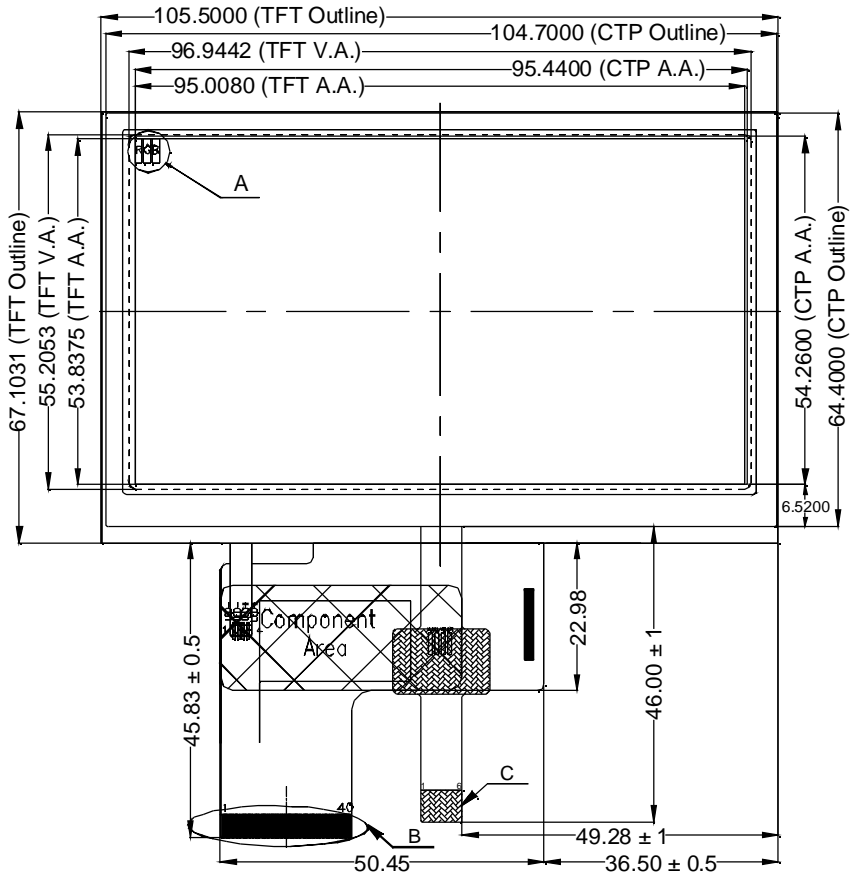

Side View (CTP)

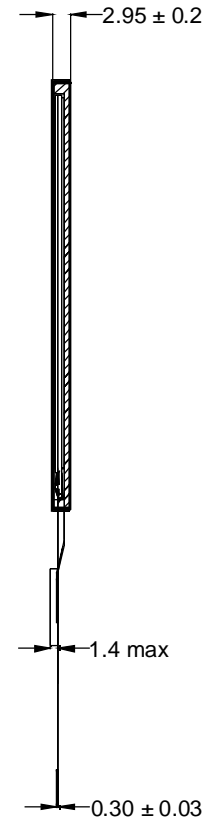

Side View (TFT)

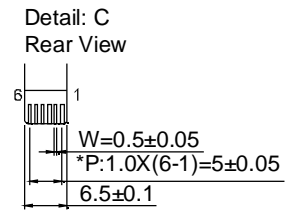
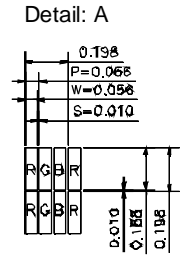

Newhaven Display

Model Name:

NHD-4.3-480272MF-ATXI#-CTP-1

Pin Description (TFT):

Pin No.	Symbol	External Connection	Function Description
1	LED-	LED Power Supply	Ground for Backlight
2	LED+	LED Power Supply	Backlight Power Supply (32mA @ 20~22V)
3	GND	Power Supply	Ground
4	VDD	Power Supply	Power supply for LCD and logic (3.3V)
5-12	[R0-R7]	MPU	Red Data Signals
13-20	[G0-G7]	MPU	Green Data Signals
21-28	[B0-B7]	MPU	Blue Data Signals
29	GND	Power Supply	Ground
30	PCLK	MPU	Data sample Clock signal
31	DISP	MPU	Display ON/OFF; DISP = 1: Display ON; DISP = 0: Display OFF
32	HSYNC	MPU	Line synchronization signal
33	VSYNC	MPU	Frame synchronization signal
34	DE	MPU	Data Enable signal
35	AVDD	-	No Connect
36	GND	Power Supply	Ground
37	XR	-	No Connect
38	YD	-	No Connect
39	XL	-	No Connect
40	YU	-	No Connect

Recommended LCD connector: 0.5mm pitch 40-Conductor FFC. Molex p/n: 54132-4097

Backlight connector: on LCD connector **Mates with:** ---

Driver Information

Built-in OTA5180A.

For specific timing and color information, please download specification at

http://www.newhavendisplay.com/app_notes/OTA5180A.pdf

Pin Description (Capacitive Touch Panel):

Pin No.	Symbol	External Connection	Function Description
1	VCC	Power Supply	Power supply for logic (3.0V)
2	GND	Power Supply	Ground
3	SCL	MPU	Serial I2C Clock (Requires pull-up resistor)
4	SDA	MPU	Serial I2C Data (Requires pull-up resistor)
5	/INT	MPU	Interrupt signal from touch panel module to host
6	/WAKE	MPU	External interrupt signal from host (0: Disable /INT 1: Enable /INT)

Recommended connector: 1.0mm pitch 6-Conductor FFC. Molex p/n: 52271-0679

Controller Information

Built-in FocalTech FT5x06 Capacitive Touch Controller.

For specific timing and register information, please download specification at

http://www.newhavendisplay.com/app_notes/FT5x06.pdf

Electrical Characteristics (TFT):

Item	Symbol	Condition	Min.	Typ.	Max.	Unit
Operating Temperature Range	Top	Absolute Max	-20	-	+70	°C
Storage Temperature Range	Tst	Absolute Max	-30	-	+80	°C
Supply Voltage	VDD		3.0	3.3	3.6	V
Power Dissipation (White screen)		fV=60Hz	-	80	95	mW
Power Dissipation (Black screen)		fV=60Hz	-	85	100	mW
VSYNC frequency	fV		-	60	70	Hz
HSYNC frequency	fH		-	17.26	-	kHz
PCLK frequency	fPCLK		-	9.2	-	MHz
Backlight Supply Voltage	VLED		20	-	22	V
Backlight Supply Current	ILED	VLED=21.0V	-	32	40	mA
Backlight Power Consumption	PBL		-	650	-	mW

Optical Characteristics (TFT):

Item	Symbol	Condition	Min.	Typ.	Max.	Unit
Viewing Angle –Top		Cr ≥10	-	15	-	°
Viewing Angle –Bottom		Cr ≥10	-	35	-	°
Viewing Angle – Left		Cr ≥ 10	-	45	-	°
Viewing Angle – Right		Cr ≥ 10	-	45	-	°
Contrast Ratio	Cr		-	400	-	
Luminance	YL		380	-	480	cd/m ²
Response Time (rise)	Tr	-	-	5	15	ms
Response Time (fall)	Tr	-	-	15	30	ms

Electrical Characteristics (Capacitive Touch):

Item	Symbol	Condition	Min.	Typ.	Max.	Unit
Operating Temperature Range	Top	Absolute Max	-20	-	+70	°C
Storage Temperature Range	Tst	Absolute Max	-30	-	+80	°C
Supply Voltage	VDD		2.8	-	3.3	V
Supply Current – Operating	IDD	Ta=25°C, VDD=2.8V	-	6.0	-	mA
Supply Current – Hibernate	IDD	Ta=25°C, VDD=2.8V	-	0.03	-	mA
“H” Level input	Vih		0.7 VCC	-	VDD	V
“L” Level input	Vil		-0.3	-	0.3 VCC	V
“H” Level output	Voh		0.7 VCC	-	-	V
“L” Level output	Vol			-	0.3 VCC	V

Material Characteristics (Capacitive Touch):

Property	Requirement	Unit
IC	FT5306DE3	
Glass thickness	0.7mm	mm
Top film thickness	0.125mm	mm
Surface Hardness	6(750)	H(g)
Light transmission	82%	
Operating Temperature	-20~70	°C
Storage Temperature	-30~80	°C
Operating Humidity	45~85	RH
Storage Humidity	5~95	RH

Capacitive Touch registers:

Address	Name	B7	B6	B5	B4	B3	B2	B1	B0	Access
00h	DEVICE_MODE	Device Mode [2..0]								R/W
01h	GEST_ID	Gesture ID [7..0]								R
02h	TD_STATUS	Touch Points [3..0]								R
03h	TOUCH1_XH	Event Flag				1st Touch X Position MSB [11..8]				R
04h	TOUCH1_XL	1st Touch X Position LSB [7..0]								R
05h	TOUCH1_YH	Touch ID [3..0]				1st Touch Y Position MSB [11..8]				R
06h	TOUCH1_YL	1st Touch Y Position LSB [7..0]								R
07h										R
08h										R
09h	TOUCH2_XH	Event Flag				2nd Touch X Position MSB [11..8]				R
0Ah	TOUCH2_XL	2nd Touch X Position LSB [7..0]								R
0Bh	TOUCH2_YH	Touch ID [3..0]				2nd Touch Y Position MSB [11..8]				R
0Ch	TOUCH2_YL	2nd Touch Y Position LSB [7..0]								R
0Dh										R
0Eh										R
0Fh	TOUCH3_XH	Event Flag				3rd Touch X Position MSB [11..8]				R
10h	TOUCH3_XL	3rd Touch X Position LSB [7..0]								R
11h	TOUCH3_YH	Touch ID [3..0]				3rd Touch Y Position MSB [11..8]				R
12h	TOUCH3_YL	3rd Touch Y Position LSB [7..0]								R
13h										R
14h										R
15h	TOUCH4_XH	Event Flag				4th Touch X Position MSB [11..8]				R
16h	TOUCH4_XL	4th Touch X Position LSB [7..0]								R
17h	TOUCH4_YH	Touch ID [3..0]				4th Touch Y Position MSB [11..8]				R
18h	TOUCH4_YL	4th Touch Y Position LSB [7..0]								R
19h										R
1Ah										R
1Bh	TOUCH5_XH	Event Flag				5th Touch X Position MSB [11..8]				R
1Ch	TOUCH5_XL	5th Touch X Position LSB [7..0]								R
1Dh	TOUCH5_YH	Touch ID [3..0]				5th Touch Y Position MSB [11..8]				R
1Eh	TOUCH5_YL	5th Touch Y Position LSB [7..0]								R
1Fh										R
20h										R

Address	Name	B7	B6	B5	B4	B3	B2	B1	B0	Access
80h	ID_G_THGROUP	valid touching detect threshold								R/W
81h	ID_G_THPEAK	valid touching peak detect threshold								R/W
82h	ID_G_THCAL	the threshold when calculating the focus of touching								R/W
83h	ID_G_THWATER	the threshold when there is surface water								R/W
84h	ID_G_TEMP	the threshold of temperature compensation								R/W
85h	ID_G_THDIFF	the threshold whether the coordinate is different from original								R/W
86h	ID_G_CTRL							Power Control Mode [1..0]		R/W
87h	ID_G_TIME_ENTER_MONITOR	the timer for entering monitor status								R/W
88h	ID_G_PERIODACTIVE							Period Active [3..0]		R/W
89h	ID_G_PERIODMONITOR	the timer of entering idle when in monitor status								R/W
A0h	ID_G_AUTO_CLB_MODE	auto calibration mode								R/W
A1h	ID_G_LIB_VERSION_H	Firmware Library Version H byte								R
A2h	ID_G_LIB_VERSION_L	Firmware Library Version L byte								R
A3h	ID_G_CIPHER	Chip vendor ID								R
A4h	ID_G_MODE	the interrupt status to host								R/W
A5h	ID_G_PMODE	Power Consume Mode								R/W
A6h	ID_G_FIRMID	Firmware ID								R
A7h	ID_G_STATE	Running State								R
A8h	ID_G_FT5201ID	CTPM Vendor ID								R
A9h	ID_G_ERR	Error Code								R
AAh	ID_G_CLB	Configure TP module during calibration in Test Mode								R/W
AEh	ID_G_B_AREA_TH	The threshold of big area								R/W
FDh	RESERVED									
FEh	LOG_MSG_CNT	The log MSG count								R
FFh	LOG_CUR_CHA	Current character of log message								R

NOTE: Registers 80h – AFh have been configured for optimum settings and do not need to be modified.

Register No	Register Name	Bits	Value	Description
00h	Device Mode	[2:0]	000b	Normal Operating Mode
			100b	Test Mode - read raw data (reserved)
			001b	System Information Mode (reserved)
01h	Gesture ID	[7:0]	48h	Zoom In
			49h	Zoom Out
			00h	No Gesture
02h	Touch Points	[3:0]	000b	0 touch points detected
			001b	1 touch point detected
			010b	2 touch points detected
			011b	3 touch points detected
			100b	4 touch points detected
			101b	5 touch points detected
03h	Touch 1 Event Flag	[7:6]	00b	Put Down
			01b	Put Up
			10b	Contact
			11b	Reserved
03h	TOUCH1_XH	[3:0]	0h - 1h	Upper 4 bits of X touch coordinate
04h	TOUCH1_XL	[7:0]	00h - FFh	Lower 8 bits of X touch coordinate
05h	TOUCH1_YH	[3:0]	0h - 1h	Upper 4 bits of Y touch coordinate
06h	TOUCH1_YL	[7:0]	00h - FFh	Lower 8 bits of Y touch coordinate
09h	Touch 2 Event Flag	[7:6]	00b	Put Down
			01b	Put Up
			10b	Contact
			11b	Reserved
09h	TOUCH2_XH	[3:0]	0h - 1h	Upper 4 bits of X touch coordinate
0Ah	TOUCH2_XL	[7:0]	00h - FFh	Lower 8 bits of X touch coordinate
0Bh	TOUCH2_YH	[3:0]	0h - 1h	Upper 4 bits of Y touch coordinate
0Ch	TOUCH2_YL	[7:0]	00h - FFh	Lower 8 bits of Y touch coordinate
0Fh	Touch 3 Event Flag	[7:6]	00b	Put Down
			01b	Put Up
			10b	Contact
			11b	Reserved
0Fh	TOUCH3_XH	[3:0]	0h - 1h	Upper 4 bits of X touch coordinate
10h	TOUCH3_XL	[7:0]	00h - FFh	Lower 8 bits of X touch coordinate
11h	TOUCH3_YH	[3:0]	0h - 1h	Upper 4 bits of Y touch coordinate
12h	TOUCH3_YL	[7:0]	00h - FFh	Lower 8 bits of Y touch coordinate
15h	Touch 4 Event Flag	[7:6]	00b	Put Down
			01b	Put Up
			10b	Contact
			11b	Reserved
15h	TOUCH4_XH	[3:0]	0h - 1h	Upper 4 bits of X touch coordinate
16h	TOUCH4_XL	[7:0]	00h - FFh	Lower 8 bits of X touch coordinate
17h	TOUCH4_YH	[3:0]	0h - 1h	Upper 4 bits of Y touch coordinate
18h	TOUCH4_YL	[7:0]	00h - FFh	Lower 8 bits of Y touch coordinate

Register No	Register Name	Bits	Value	Description
1Bh	Touch 5 Event Flag	[7:6]	00b 01b 10b 11b	Put Down Put Up Contact Reserved
1Bh	TOUCH5_XH	[3:0]	0h - 1h	Upper 4 bits of X touch coordinate
1Ch	TOUCH5_XL	[7:0]	00h - FFh	Lower 8 bits of X touch coordinate
1Dh	TOUCH5_YH	[3:0]	0h - 1h	Upper 4 bits of Y touch coordinate
1Eh	TOUCH5_YL	[7:0]	00h - FFh	Lower 8 bits of Y touch coordinate
80h	ID_G_THGROUP	[7:0]	00h - FFh	Valid touching detect threshold Actual value will be 4 times register's value Recommended: 46h
81h	ID_G_THPEAK	[7:0]	00h - FFh	valid touching peak detect threshold Recommended: 3Ch
82h	ID_G_THCAL	[7:0]	00h - FFh	Touch focus threshold Recommended: 1Dh
83h	ID_G_THWATER	[7:0]	00h - FFh	threshold when there is surface water Recommended: D3h
84h	ID_G_THTEMP	[7:0]	00h - FFh	threshold of temperature compensation Recommended: EBh
85h	ID_G_THDIFF	[7:0]	00h - FFh	Touch difference threshold Actual value is 32 times the register's value Recommended: A0h
86h	ID_G_CTRL	[1:0]	00h 01h	Power Control Mode: Not Auto Jump Power Control Mode: Auto Jump
87h	ID_G_TIME_ENTER_MONITOR	[7:0]	00h-FFh	Delay to enter 'Monitor' status (s) Recommended: C8h
88h	ID_G_PERIODACTIVE	[3:0]	3h-Eh	Period of 'Active' status (ms) Recommended: 6h
89h	ID_G_PERIODMONITOR	[7:0]	1Eh-FFh	Timer to enter 'idle' when in 'Monitor' (ms) Recommended: 28h
A0h	ID_G_AUTO_CLB_MODE	[7:0]	00h FFh	Auto calibration mode: Enable auto calibration Auto calibration mode: Disable auto calibration
A1h	ID_G_LIB_VERSION_H	[7:0]	30h	Firmware Library Version H byte
A2h	ID_G_LIB_VERSION_L	[7:0]	01h	Firmware Library Version L byte
A3h	ID_G_CIPHER	[7:0]	55h	Chip vendor ID
A4h	ID_G_MODE	[0:0]	00h 01h	Interrupt status: Enable interrupt to host Interrupt status: Disable interrupt to host
A5h	ID_G_PMODE	[1:0]	00h 01h 03h	'Active' Mode 'Monitor' Mode 'Hibernate' Mode
A6h	ID_G_FIRMID	[7:0]	05h	Firmware ID
A7h	ID_G_STATE	[7:0]	00h 01h 02h 03h 04h	Running State: Configure Running State: Work Running State: Calibration Running State: Factory Running State: Auto-calibration
A8h	ID_G_FT5201ID	[7:0]	79h	CTPM Vendor's Chip ID
A9h	ID_G_ERR	[7:0]	00h 03h 05h 1Ah	Error Code: OK Error Code: Chip register writing inconsistent with reading Error Code: Chip start fail Error Code: Calibration match fail

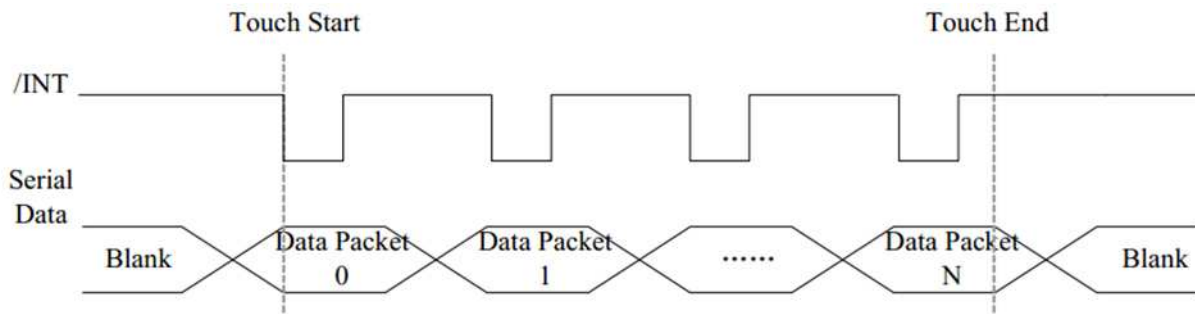

Sample code to read touch data:

```

i2c_start();
i2c_tx(0x70);
i2c_tx(0x00);
i2c_stop();

i2c_start();
i2c_tx(0x71);
for(i=0x00;i<0x1F;i++)
{touchdata_buffer[i] = i2c_rx(1);}
i2c_stop();

```

Sample code to overwrite default register values:

```

i2c_start();
i2c_tx(0x70);
i2c_tx(0xA4);           //ID_G_MODE
i2c_tx(0x01);          //Disable interrupt status to host
i2c_stop();

```

Quality Information

Test Item	Content of Test	Test Condition	Note
High Temperature storage	Endurance test applying the high storage temperature for a long time.	+80°C , 200hrs	2
Low Temperature storage	Endurance test applying the low storage temperature for a long time.	-30°C , 200hrs	1,2
High Temperature Operation	Endurance test applying the electric stress (voltage & current) and the high thermal stress for a long time.	+70°C 200hrs	2
Low Temperature Operation	Endurance test applying the electric stress (voltage & current) and the low thermal stress for a long time.	-20°C , 200hrs	1,2
High Temperature / Humidity Operation	Endurance test applying the electric stress (voltage & current) and the high thermal with high humidity stress for a long time.	+60°C , 90% RH , 96hrs	1,2
Thermal Shock resistance	Endurance test applying the electric stress (voltage & current) during a cycle of low and high thermal stress.	-20°C,30min -> 25°C,5min ->70°C,30min = 1 cycle 10 cycles	
Vibration test	Endurance test applying vibration to simulate transportation and use.	10-55Hz , 15mm amplitude. 60 sec in each of 3 directions X,Y,Z For 15 minutes	3
Static electricity test	Endurance test applying electric static discharge.	VS=800V, RS=1.5kΩ, CS=100pF One time	

Note 1: No condensation to be observed.

Note 2: Conducted after 4 hours of storage at 25°C, 0%RH.

Note 3: Test performed on product itself, not inside a container.

Precautions for using LCDs/LCMs

See Precautions at www.newhavendisplay.com/specs/precautions.pdf

Warranty Information and Terms & Conditions

http://www.newhavendisplay.com/index.php?main_page=terms